

# AZ68F

DA MAT 233

Gennaio 2023

LOCALE	CODICE	DESCRIZIONE COMPONENTE	FINITURA	Q.TA	OPERATORE
PARATIE	AZ68F-PR15	PARETE CAB. ARMATORE MURATA PRUA	OKOUME' GREZZO	4	Damiano

**104-107**  
ELIMINATA SOTTOSTRUTTURA E  
MODIFICATA SAGOMA



**FERRAMENTA:**  
N° 20 - FITLOCK FEMMINA  
N° 10 - BUSSOLA ZAMA 6MA  
N° 2 - SPINE 8 X 20

**ELEMENTO DA MONTARE con:**  
**MF\_PR15\_01**  
**MF\_PR15\_02**  
e spedire con un unico imballo

- 1 - L.842 x H 1980 x sp 19
- 2 - L.1320 x H 2000 x sp 19
- 3 - L.1508 x H 2028 x sp 19
- 4 - L.837 x H.2035 x sp 19

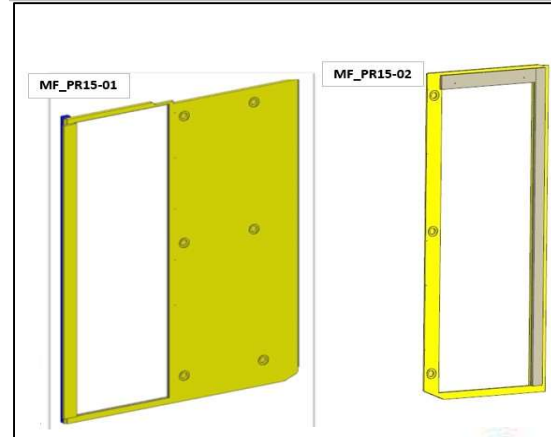

# AZ68F

DA MAT 233

REV. 2022

LOCALE	CODICE	DESCRIZIONE COMPONENTE	FINITURA	Q.TA	OPERATORE
PARATIE	AZ68F-MF_PR15_01\02	PARETE CAB. ARMATORE MURATA PRUA			Damiano

MF\_PR15-01

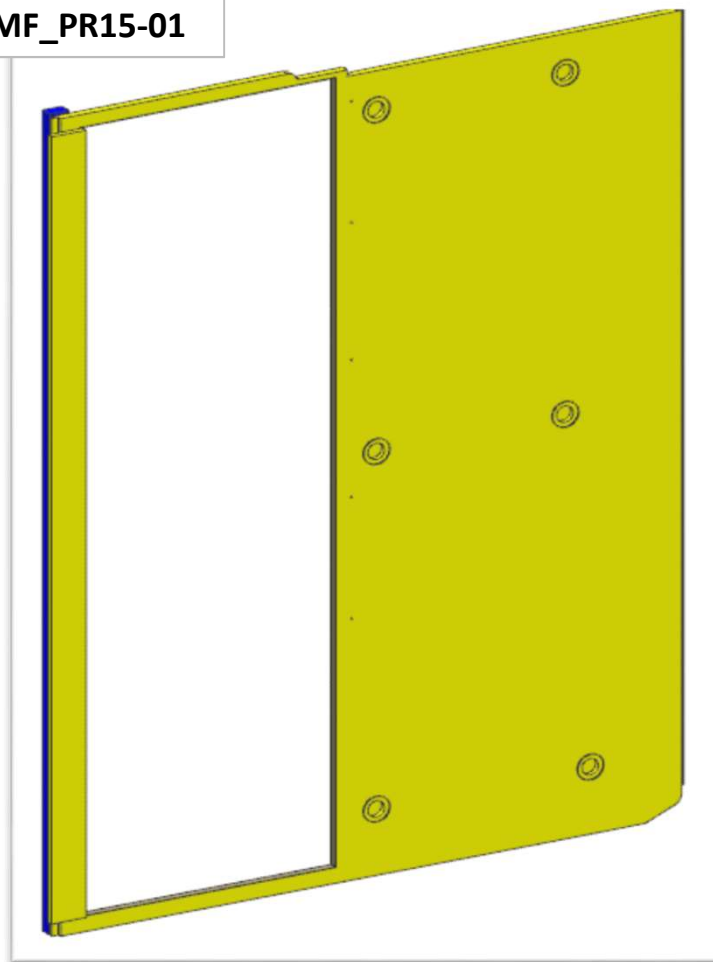

MF\_PR15-02

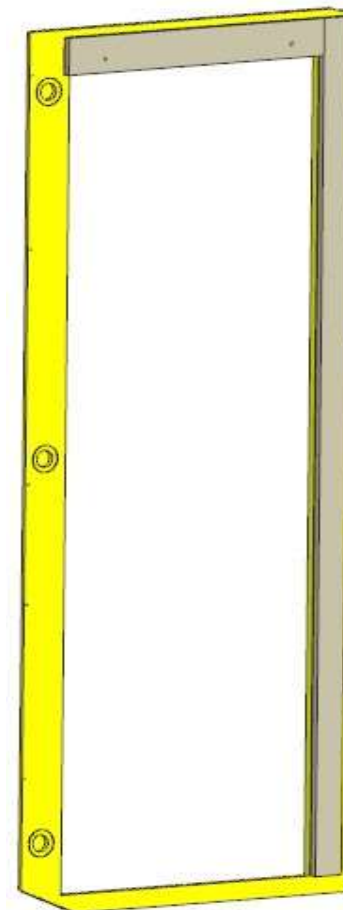

**FERRAMENTA:**

- N° 20 - FITLOCK FEMMINA
- N° 10 - BUSSOLA ZAMA 6MA
- N° 2 - SPINE 8 X 20

# AZ68F

DA MAT. 203

REV. 2022

LOCALE	CODICE	DESCRIZIONE COMPONENTE	FINITURA	Q.TA	OPERATORE
PARATIE	AZ68F-I01_PR15	PARETE CAB. ARMATORE MURATA PRUA	OKOUME' GREZZO	1	Damiano

1 - L.83 x H.1952 x sp 14

**DA MANDARE VIA  
MONTATO**



ELEMENTO DA MONTARE  
con:  
**MF\_PR15\_01**  
e spedire con un unico

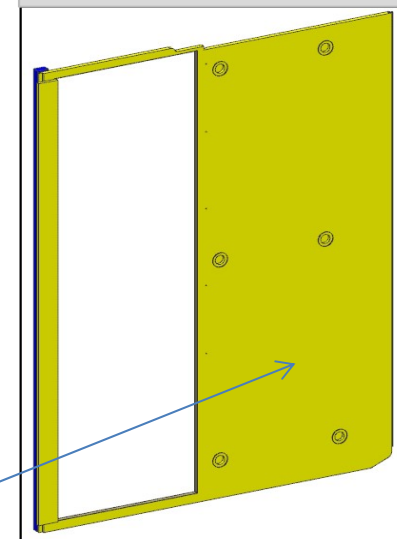

PR15

# AZ68F

DA MAT 233

REV. 29-04-2024

LOCALE	CODICE	DESCRIZIONE COMPONENTE	FINITURA	Q.TA	OPERATORE
PARATIE	AZ68F-R01_PR15	PARETE CAB. ARMATORE MURATA PRUA	LASTRA CHIARA	2	Damiano

1 - L.66 x H.1975 x sp 16  
2 - L.650 x H.86 x sp 19

H 86



2

H 1975

1

MODIFICATO  
MISURE

ELEMENTO DA  
MONTARE  
MF\_PR15\_02  
e spedire con un

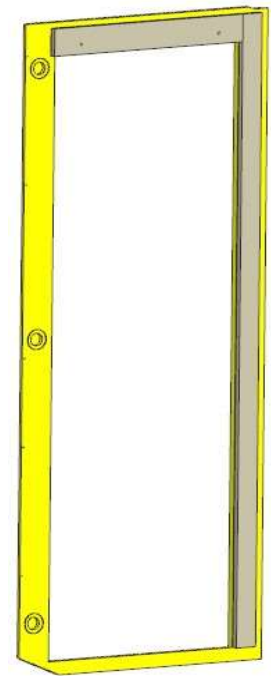

# AZ68F

DA MAT 233

REV. 2022

LOCALE	CODICE	DESCRIZIONE COMPONENTE	FINITURA	Q.TA	OPERATORE
PARATIE	AZ68F-MF_PR16	PARETE BAGNO ARM. MURATA PRUA			Damiano

**179**

MODIFICA FINITURA.  
PARETE IN LAMINATO

**FERRAMENTA:**

- N° 3 - FITLOCK MASCHIO
- N° 17 - FITLOCK FEMMINA
- N° 16 - BUSSOLA ZAMA 6MA
- N° 11 - VITI 6MA X 25 TB

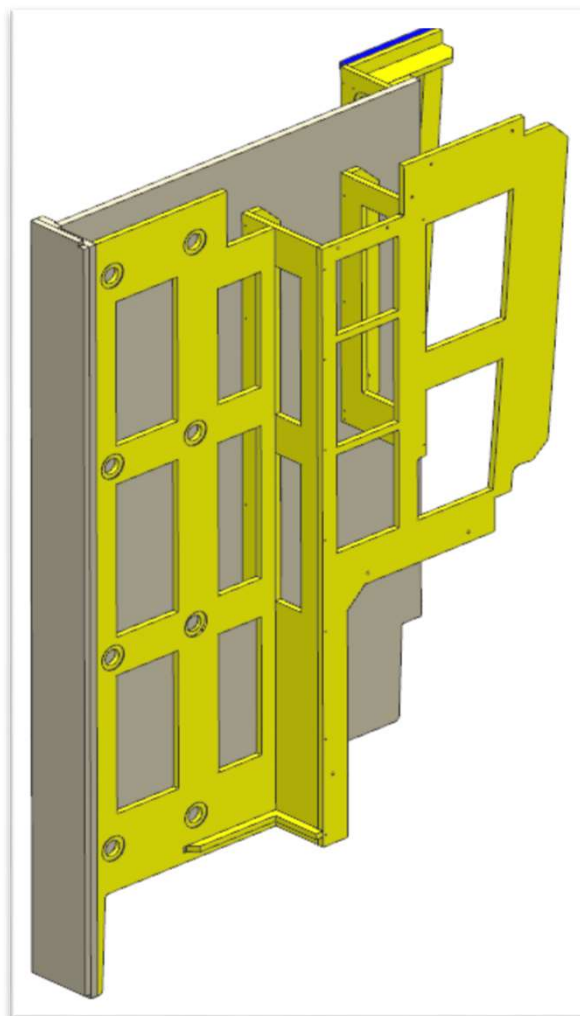

# AZ68F

DA MAT 233

Gennaio 2023

LOCALE	CODICE	DESCRIZIONE COMPONENTE	FINITURA	Q.TA	OPERATORE
PARATIE	AZ68F-PR16	PARETE BAGNO ARM. MURATA PRUA	OKOUME' GREZZO	2	Damiano

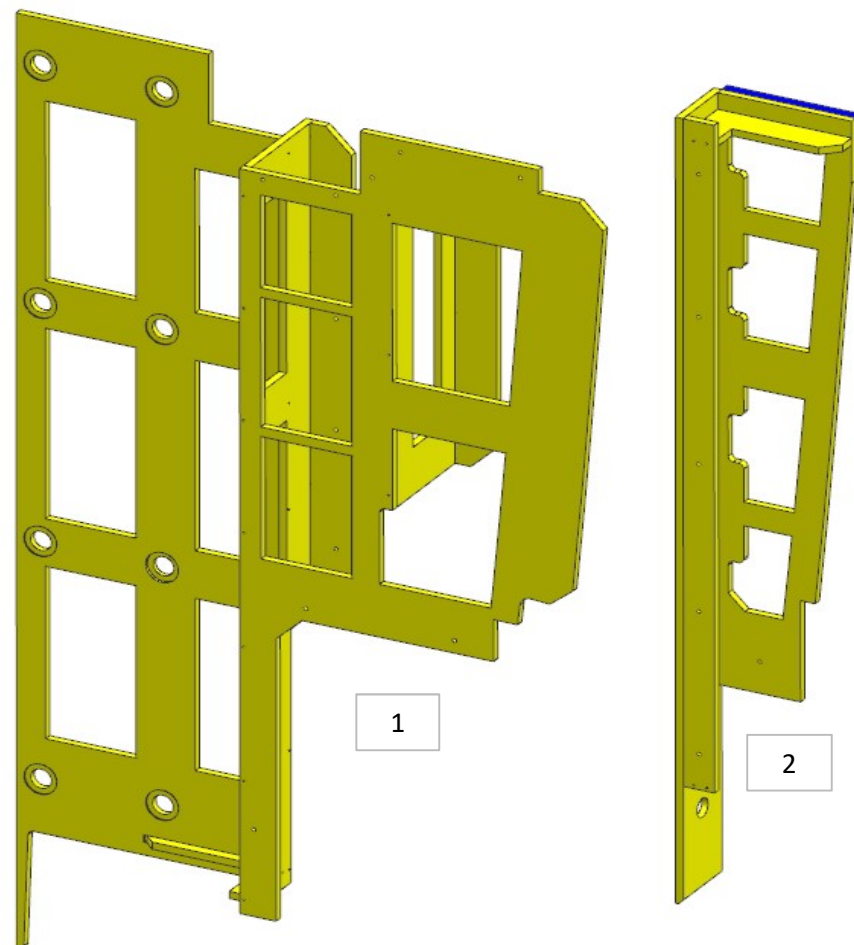

**179**  
MODIFICA FINITURA.  
PARETE IN LAMINATO

**FERRAMENTA:**  
N° 3 - FITLOCK MASCHIO  
N° 17 - FITLOCK FEMMINA  
N° 16 - BUSSOLA ZAMA 6MA  
N° 11 - VITI 6MA X 25 TB

ELEMENTO DA MONTARE  
con:  
**R01\_PR16**  
e spedire con un unico

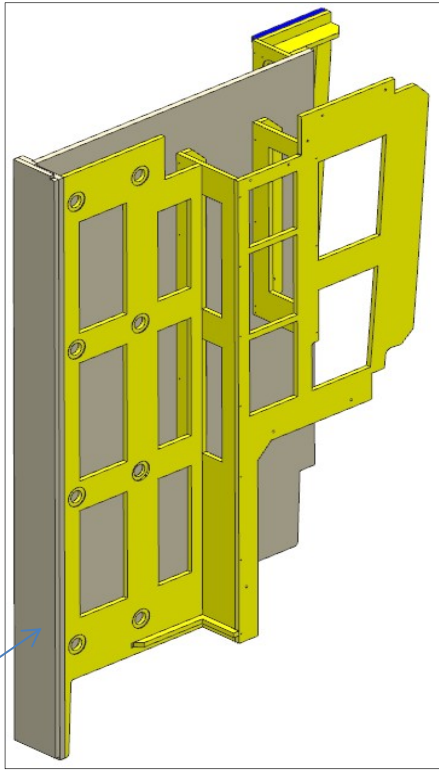

R01\_PR16

# AZ68F

DA MAT.216

REV. 29-04-2024

LOCALE	CODICE	DESCRIZIONE COMPONENTE	FINITURA	Q.TA	OPERATORE
PARATIE	AZ68F-R01_PR16	PARETE BAGNO ARM. MURATA PRUA	LASTRA CHIARA	3	Damiano

- 1 - L 1014 x H 1979 x sp 19mm
- 2 - L 159 x H 1979 x sp 19mm
- 3 - L 159 x H 1967 x sp 16mm

**179**  
MODIFICATA FINITURA.  
DA LAMINATO A LASTRA

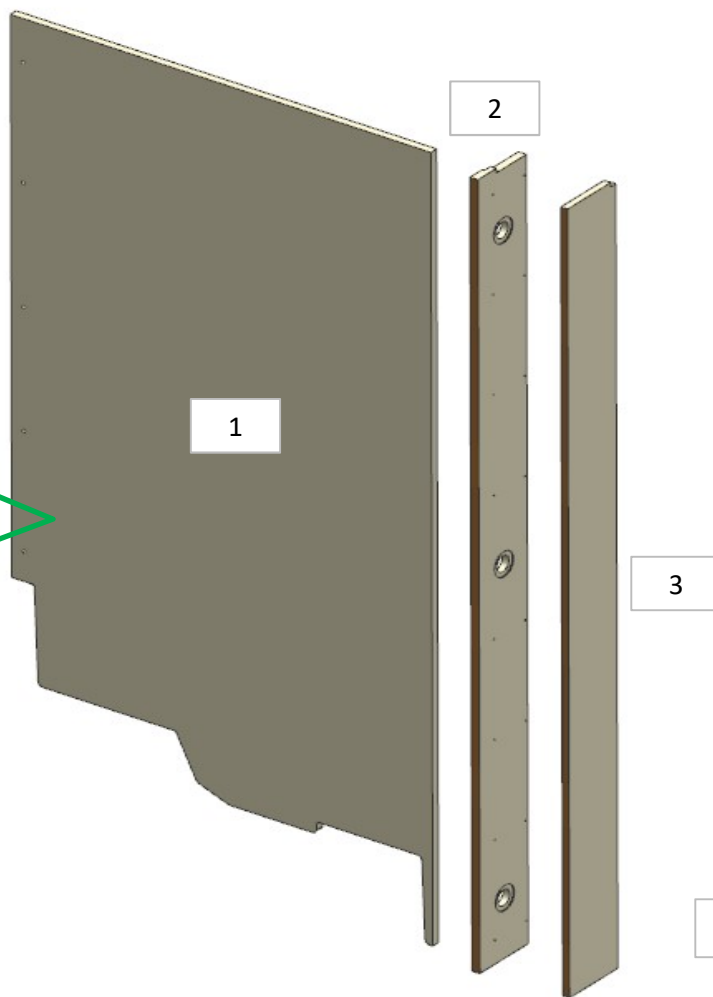

ELEMENTO DA MONTARE  
con:  
**PR16**  
e spedire con un unico

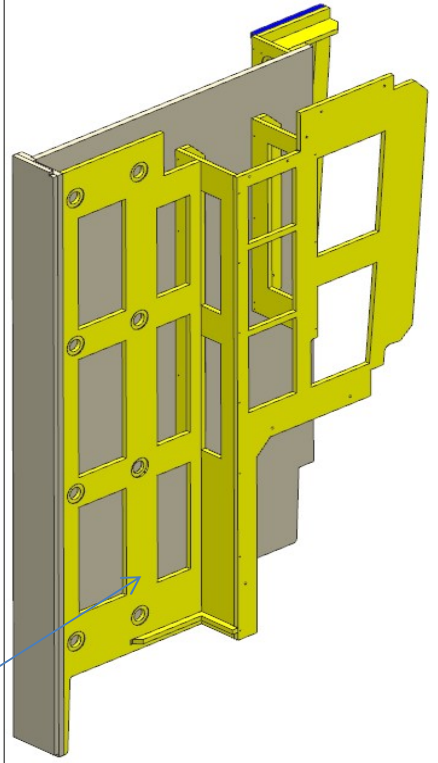

PR16

# AZ68F

DA MAT 265

REV. 29-04-2024

LOCALE	CODICE	DESCRIZIONE COMPONENTE	FINITURA	Q.TA	OPERATORE
PARATIE	AZ68F-PR17	PARETE BAGNO ARM. MURATA POPPA	OKOUME' GREZZO	1	Damiano

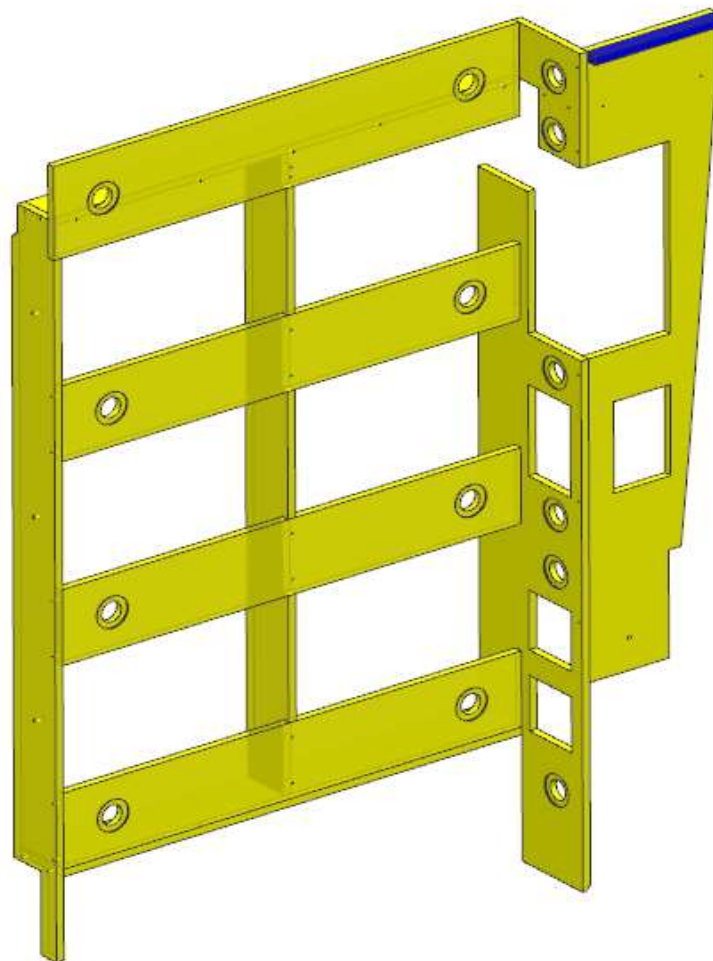

**179**  
MODIFICA FINITURA.  
PARETE IN LAMINATO

- FERRAMENTA:**
- N° 8 - FITLOCK MASCHIO
  - N° 14 - FITLOCK FEMMINA
  - N° 1 - BUSSOLA ZAMA 6MA

# AZ68F

DA MAT.265

REV. 29-04-2024

LOCALE	CODICE	DESCRIZIONE COMPONENTE	FINITURA	Q.TA	OPERATORE
PARATIE	AZ68F-R01_PR17	PARETE BAGNO ARM. MURATA POPPA	LASTRA CHIARA	1	Damiano

1 - L 933 x H 1653 x sp 16mm

**179**  
MODIFICATA FINITURA.  
DA LAMINATO A LASTRA

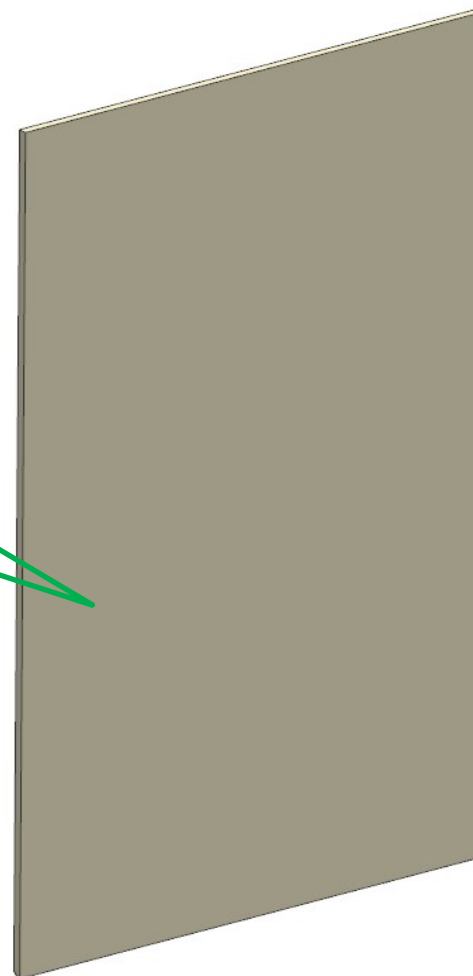

# AZ68F

DA MAT 233

Gennaio 2023

LOCALE	CODICE	DESCRIZIONE COMPONENTE	FINITURA	Q.TA	OPERATORE
PARATIE	AZ68F-PR18	STRUTT. BAGNO ARMATORE BASSA OBLO	OKOUME' GREZZO	1	Damiano

1 - L 818 x H.522 x 174

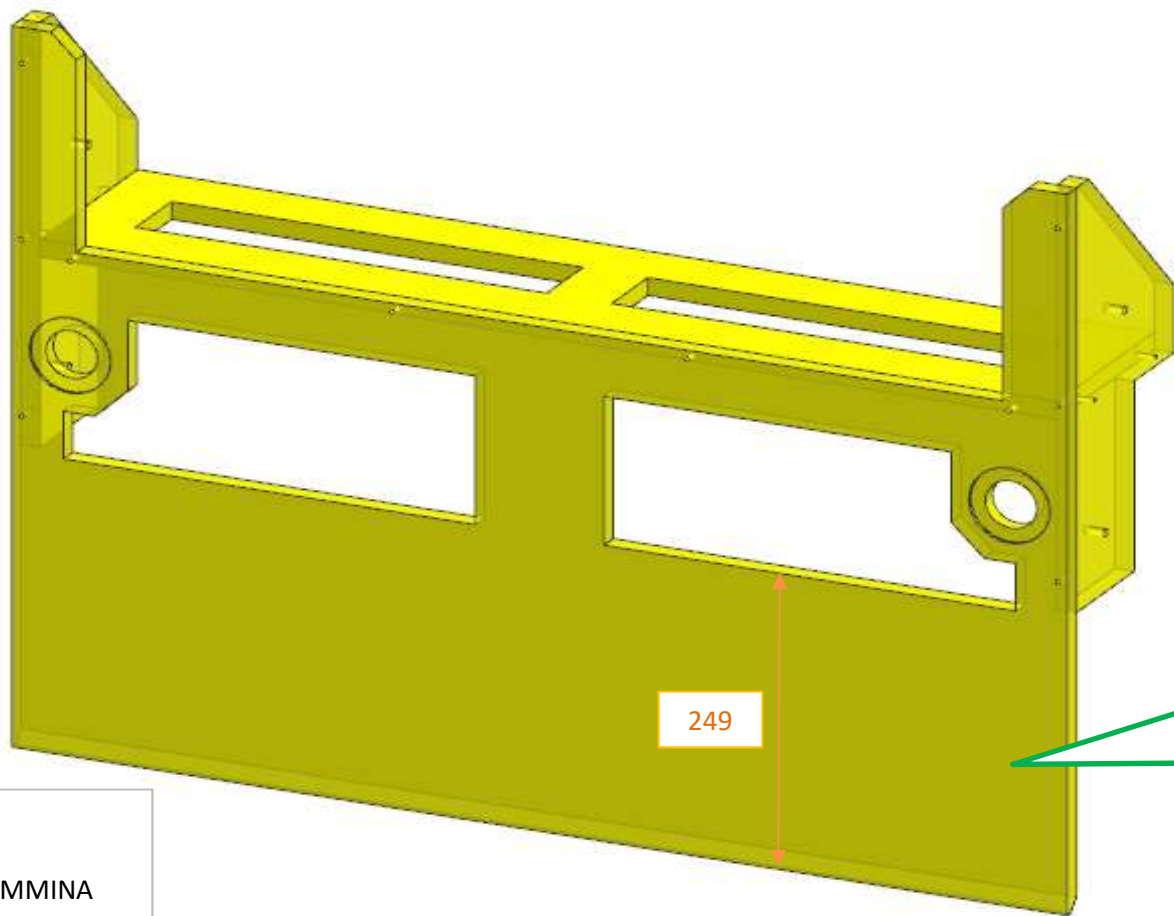

29  
ALLUNGATO  
PANNELLO

**FERRAMENTA:**  
N° 2 - FITLOCK FEMMINA

# AZ68F

DA MAT 233

Gennaio 2023

LOCALE	CODICE	DESCRIZIONE COMPONENTE	FINITURA	Q.TA	OPERATORE
PARATIE	AZ68F-PR19	STRUTT. BAGNO ARMATORE ALTA OBLO	OKOUME' GREZZO	1	Damiano

1 - L.818 x H.258 x sp 15

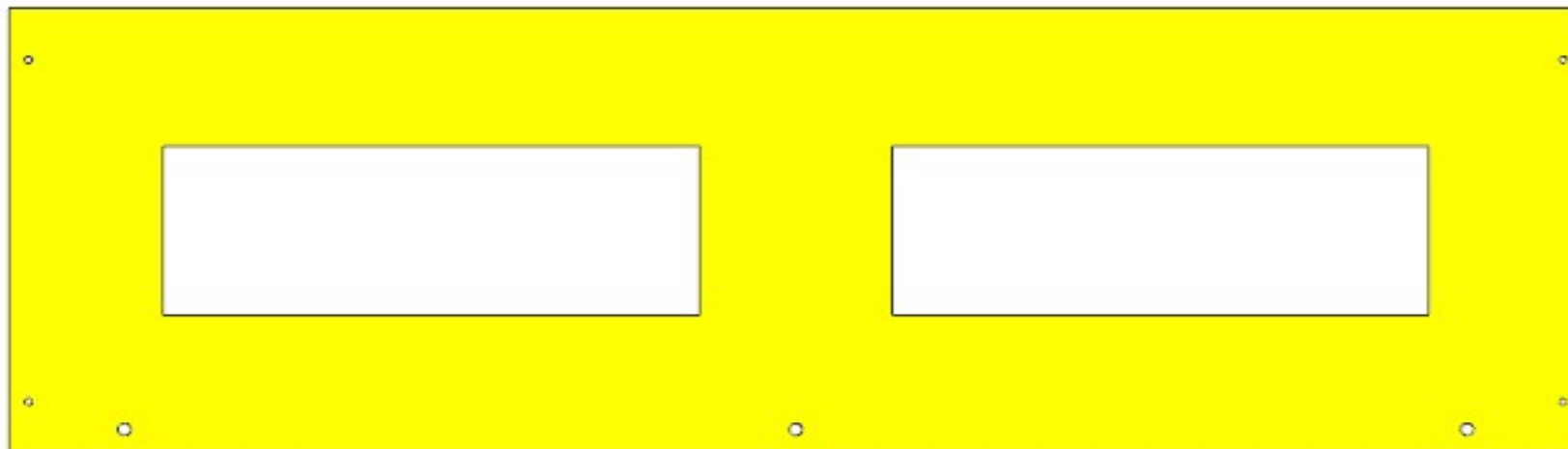

# AZ68F

DA MAT 233

REV. 2022

LOCALE	CODICE	DESCRIZIONE COMPONENTE	FINITURA	Q.TA	OPERATORE
PARATIE	AZ68F-MF_PR20	PARETE BAGNO ARMATORE SX LAVABO			Damiano

INSERITO FORO  
PRESA SU LASTRA E  
STRUTTURA

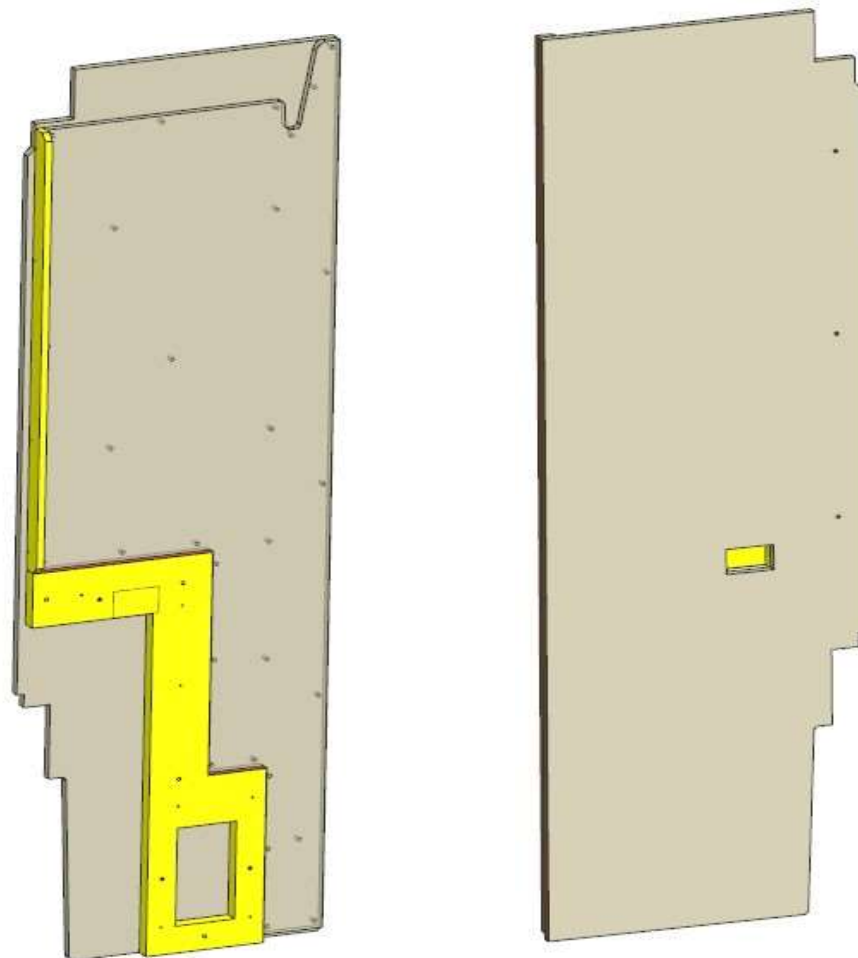

**FERRAMENTA:**

N° 10 - BUSSOLA ZAMA 6MA  
N° 29 - SPINE

# AZ68F

DA MAT 233

REV. 29-04-2024

LOCALE	CODICE	DESCRIZIONE COMPONENTE	FINITURA	Q.TA	OPERATORE
PARATIE	AZ68F-R01_PR20	PARETE BAGNO ARMATORE SX LAVABO	LASTRA CHIARA	2	Damiano

1 - L.608 x H 1967 x sp 16mm  
2 - L 638 x H 1979 x sp 19mm

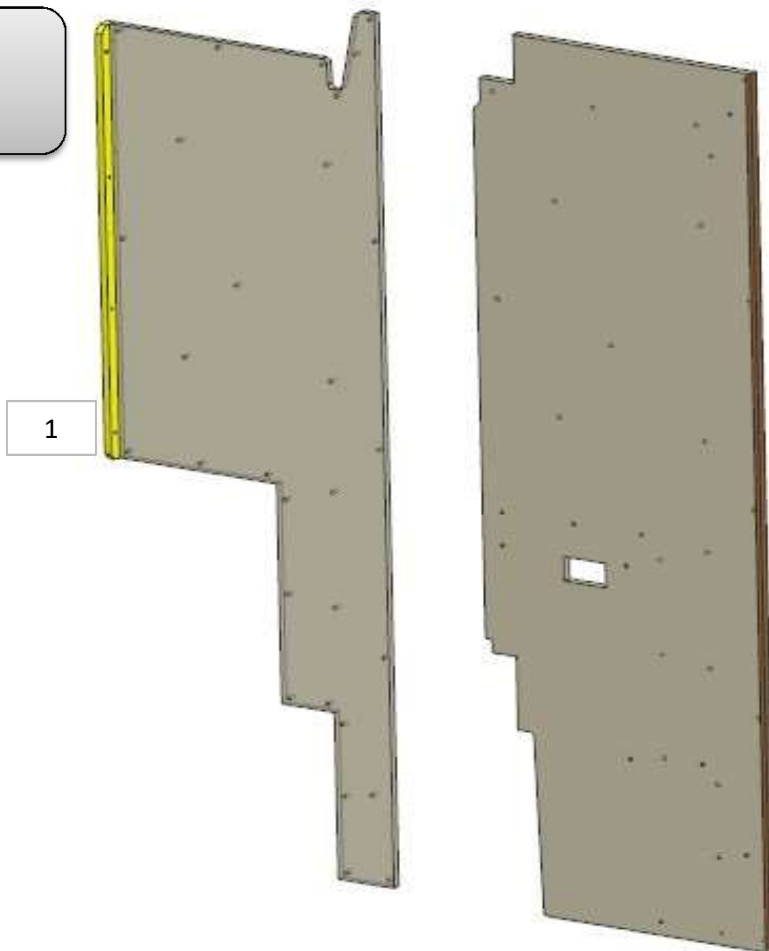

ELEMENTO DA MONTARE con:  
**L01\_PR20**  
e spedire con un unico imballo

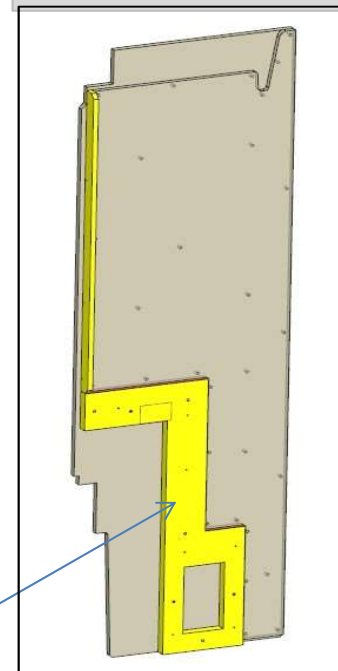

L01\_PR20

# AZ68F

DA MAT 233

REV. 2022

LOCALE	CODICE	DESCRIZIONE COMPONENTE	FINITURA	Q.TA	OPERATORE
PARATIE	AZ68F-L01_PR20	PARETE BAGNO ARMATORE SX LAVABO	LACCATO BRONZO (BORDO)	1	Damiano

1 - L 494 x H.882 x sp 30

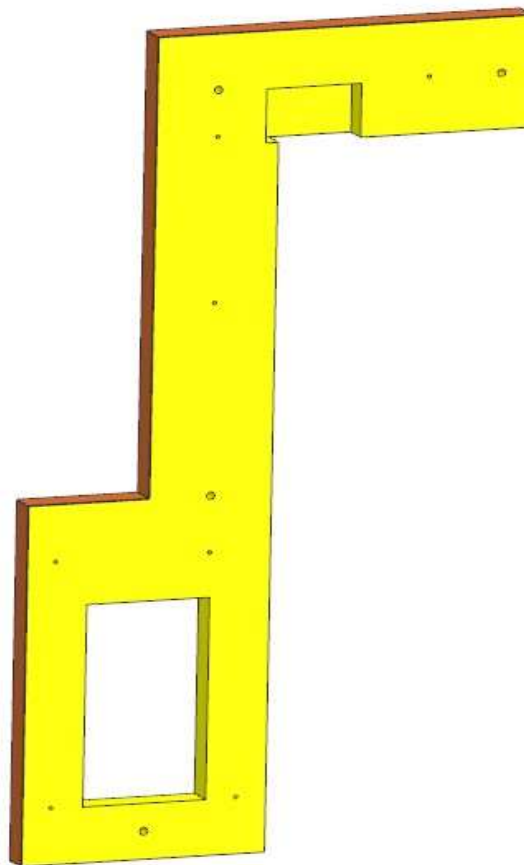

ELEMENTO DA MONTARE con:  
**R01\_PR20**  
e spedire con un unico imballo

R01\_PR20

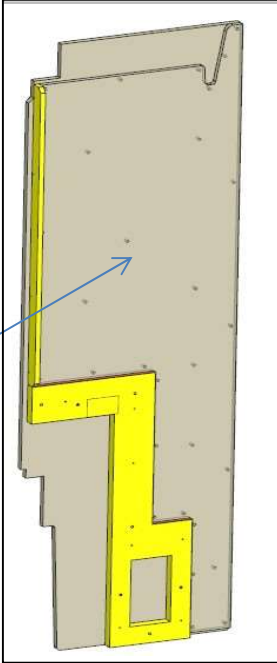

# AZ68F

DA MAT.233

REV. 2022

LOCALE	CODICE	DESCRIZIONE COMPONENTE	FINITURA	Q.TA	OPERATORE
PARATIE	AZ68F-MF_PR21	PARETE BAGNO ARMATORE DX LAVABO			Damiano

**179**  
PARETE LASTRA BORDARE  
FILI INTERNI.  
PARETE LAMINATO  
RASARE E VERNICIARE  
BIANCO FILI INTERNI.

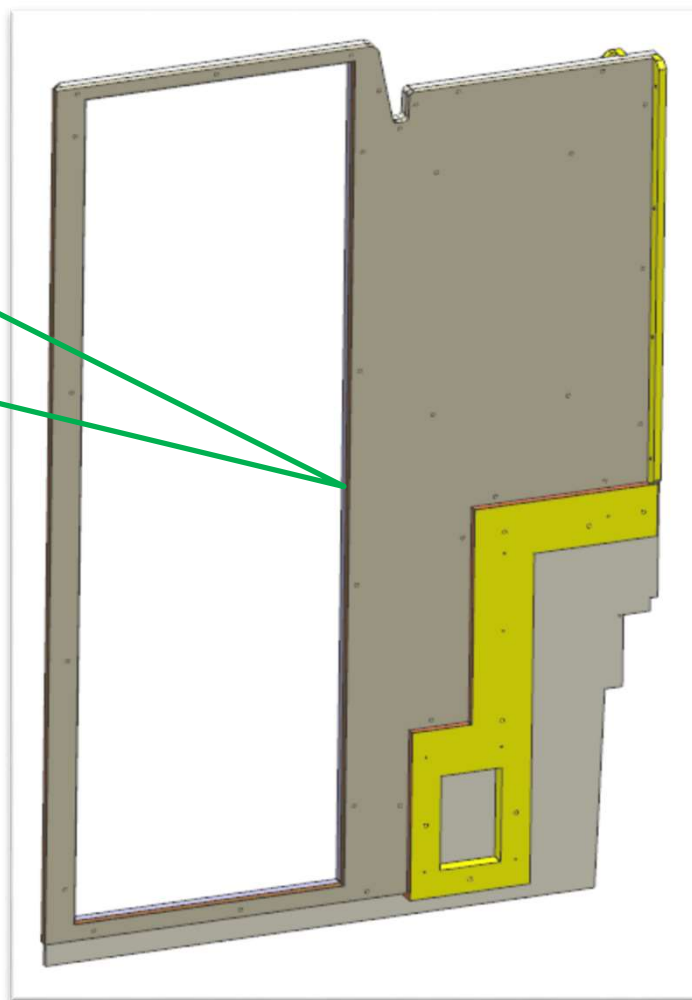

**FERRAMENTA:**

N° 13 - BUSSOLA ZAMA 6MA  
N° 4 - VITI 6MA X25 TS  
N° 31 - SPINE 8X20

# AZ68F

DA MAT 233

Gennaio 2023

LOCALE	CODICE	DESCRIZIONE COMPONENTE	FINITURA	Q.TA	OPERATORE
PARATIE	AZ68F-PR21	PARETE BAGNO ARMATORE DX LAVABO	LAMINATO RESINA	1	Damiano

1 - L.1236 x H 2024 x sp 20

**179**

RASARE E LACCARE  
BIANCO IL FILO GREZZO  
VANO PORTA

**109**

AGGIUNTA TACCA

**FERRAMENTA:**

N° 13 - BUSSOLA ZAMA 6MA  
N° 4 - VITI 6MA X25 TS  
N° 31 - SPINE 8X20

ELEMENTO DA MONTARE

con:

R01\_PR21

L01\_PR21

e spedire con un unico  
imballo

R01\_PR21

L01\_PR21

consonni&c

# AZ68F

DA MAT.216

REV. 29-04-2024

LOCALE	CODICE	DESCRIZIONE COMPONENTE	FINITURA	Q.TA	OPERATORE
PARATIE	AZ68F-R01_PR21	PARETE BAGNO ARMATORE DX LAVABO	LASTRA CHIARA	1	Damiano

1 - L.1214 x H 1967 x sp 16mm

**179**  
BORDARE FILI INTERNI  
VANO PORTA

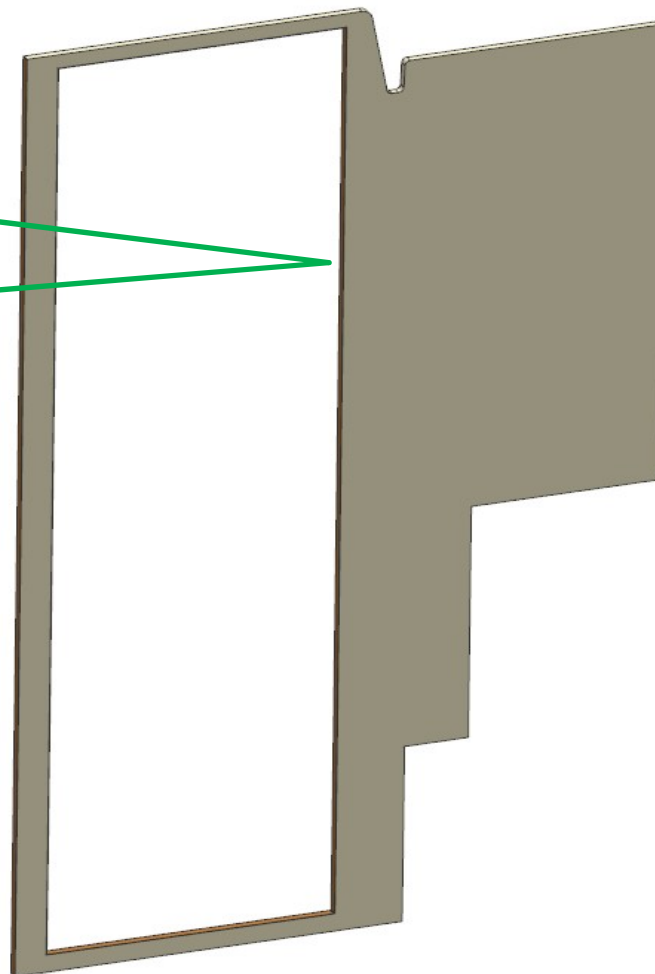

ELEMENTO DA MONTARE  
con:  
**PR21**  
**L01\_PR21**  
e spedire con un unico  
imballo

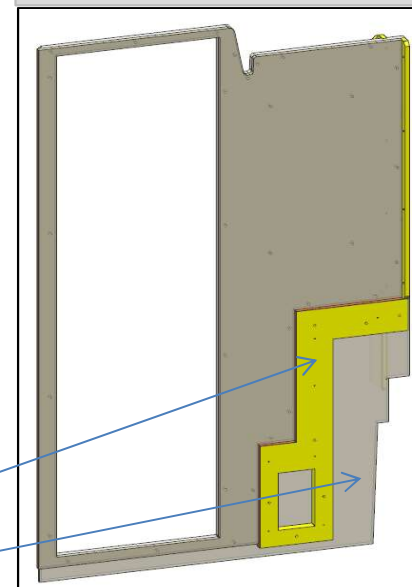

L01\_PR21

PR21

# AZ68F

REV. 2022

LOCALE	CODICE	DESCRIZIONE COMPONENTE	FINITURA	Q.TA	OPERATORE
PARATIE	AZ68F-L01_PR21	PARETE BAGNO ARMATORE DX LAVABO	LACCATO BRONZO (BORDO)	1	Damiano

1 - L.989 x H.882 x sp 30

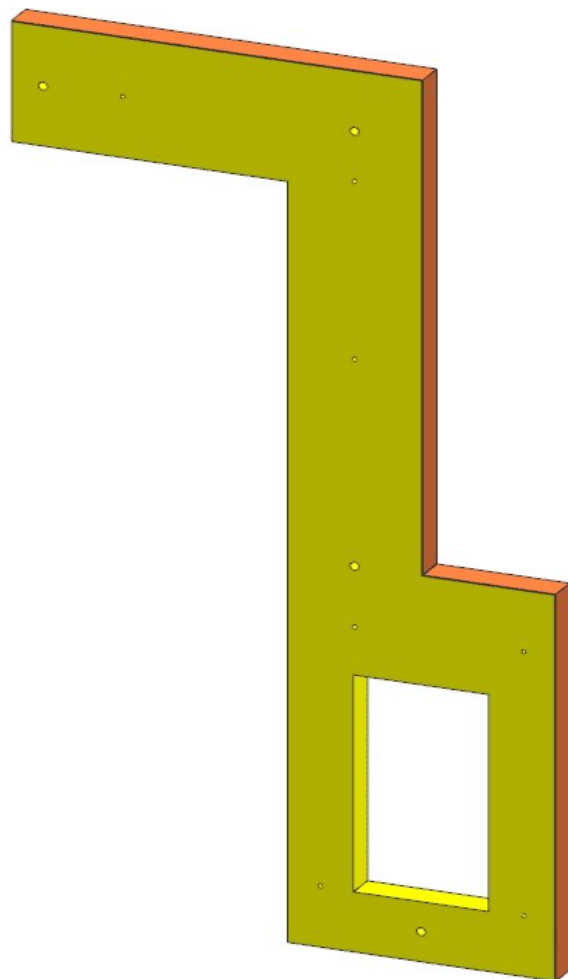

ELEMENTO DA MONTARE  
con:  
**R01\_PR21**  
**PR21**  
e spedire con un unico  
imballo

R01\_PR21

PR21

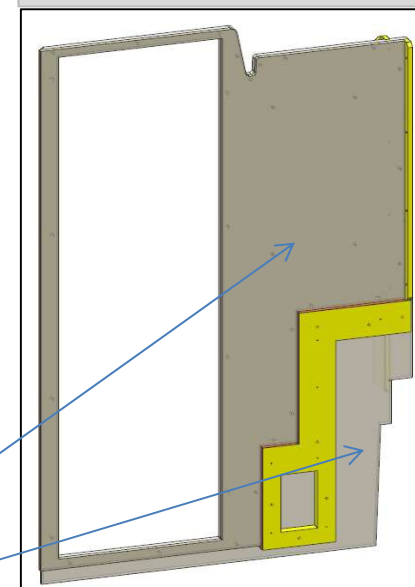

# AZ68F

REV. 2022

DA MAT 237

LOCALE	CODICE	DESCRIZIONE COMPONENTE	FINITURA	Q.TA	OPERATORE
PARATIE	AZ68F-A01_PR21	PARETE BAGNO ARMAT. DX LAVABO	ACCIAIO	1	Damiano

1 - L.546 x H 36 x 3

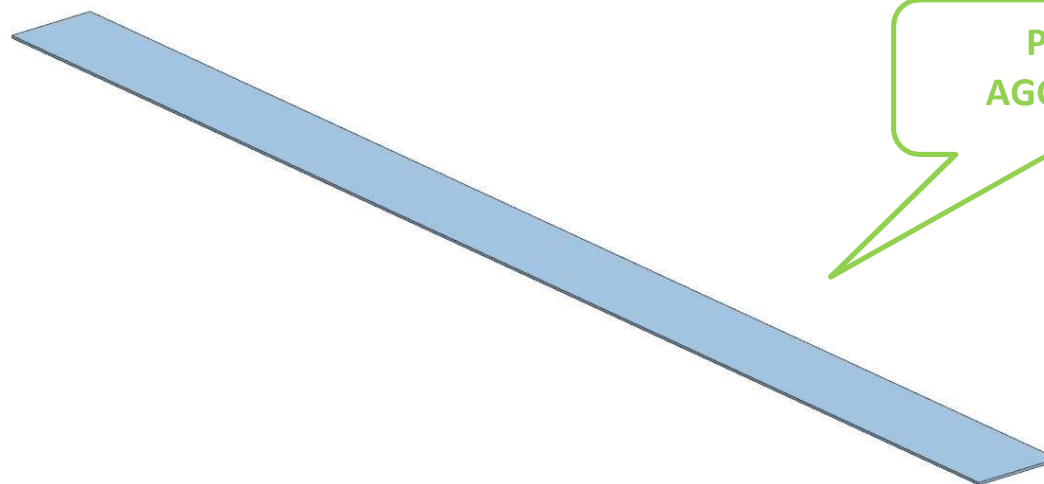

# AZ68F

DA MAT 233

Gennaio 2023

LOCALE	CODICE	DESCRIZIONE COMPONENTE	FINITURA	Q.TA	OPERATORE
PARATIE	AZ68F-PR22	STRUT. BAGNO ARM. SPECCHIO LAVABO	OKOUME' GREZZO	1	Damiano

1 - L.811 x H.976 x sp 15

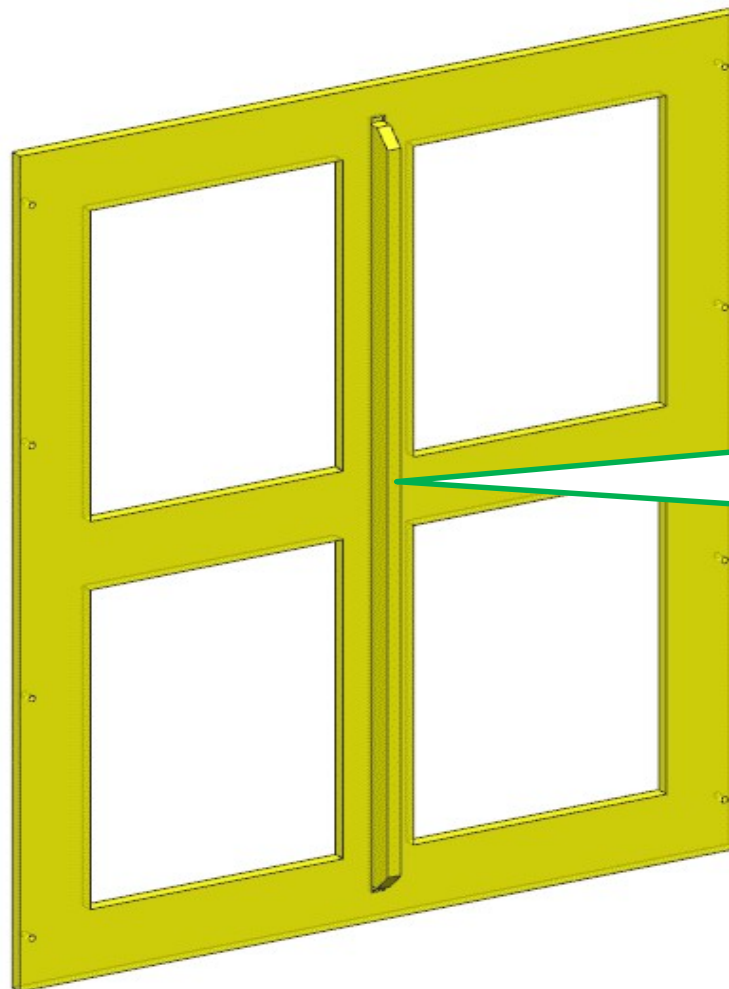

**25**  
RIDOTTO LUNGHEZZA  
LISTELLO = 890mm

# AZ68F

DA MAT 233

Gennaio 2023

LOCALE	CODICE	DESCRIZIONE COMPONENTE	FINITURA	Q.TA	OPERATORE
PARATIE	AZ68F-PR23	PARETE BAGNO ARMATORE DX DOCCIA	LAMINATO RESINA\ OKOUME'	2	Damiano

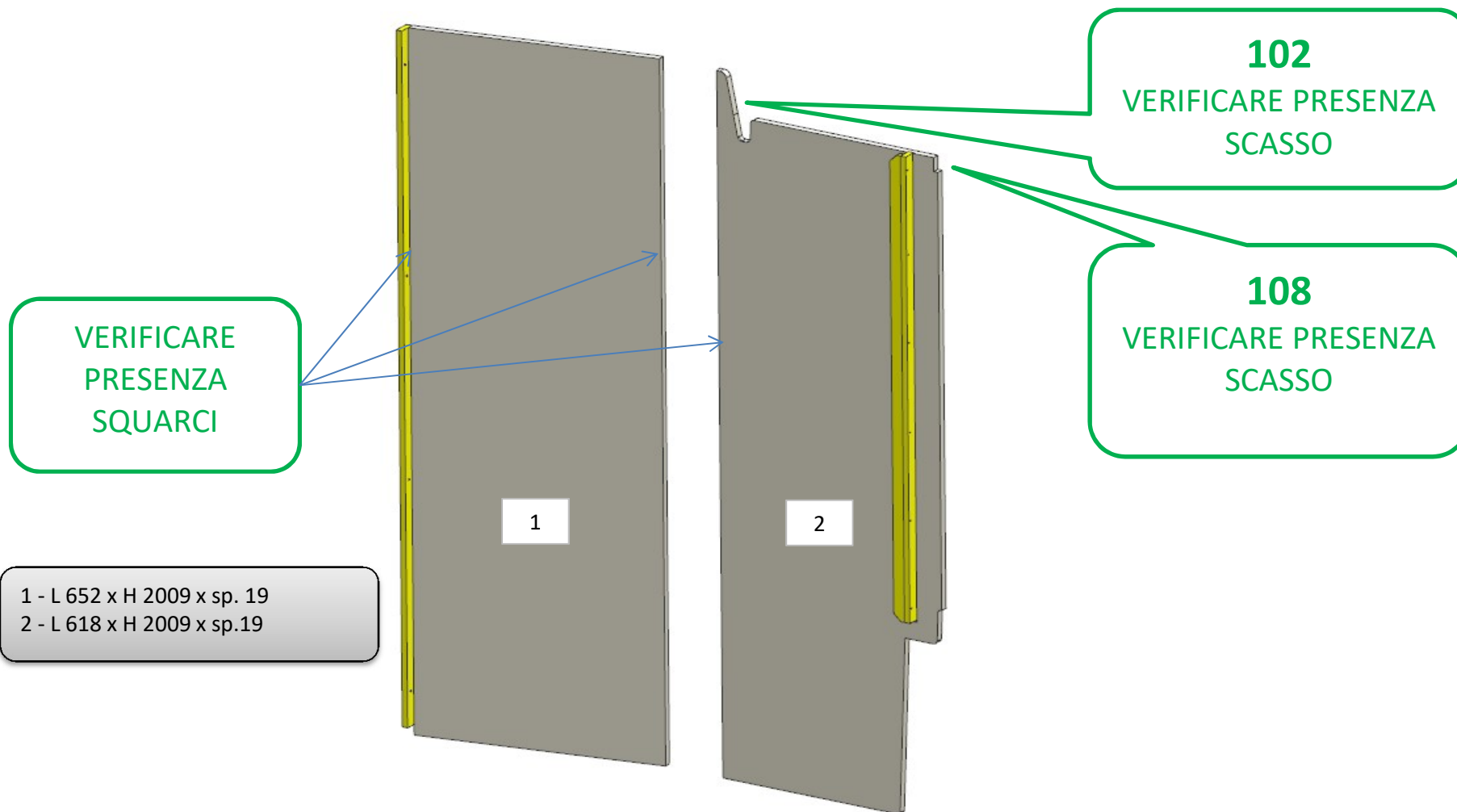

# AZ68F

DA MAT. 201

REV. 2022

LOCALE	CODICE	DESCRIZIONE COMPONENTE	FINITURA	Q.TA	OPERATORE
PARATIE	AZ68F-I01_PR23	STRUT. BAGNO ARM. SPECCHIO LAVABO	OKOUME' GREZZO	1	Dante

1 - L.680 x H.1954 x sp 12

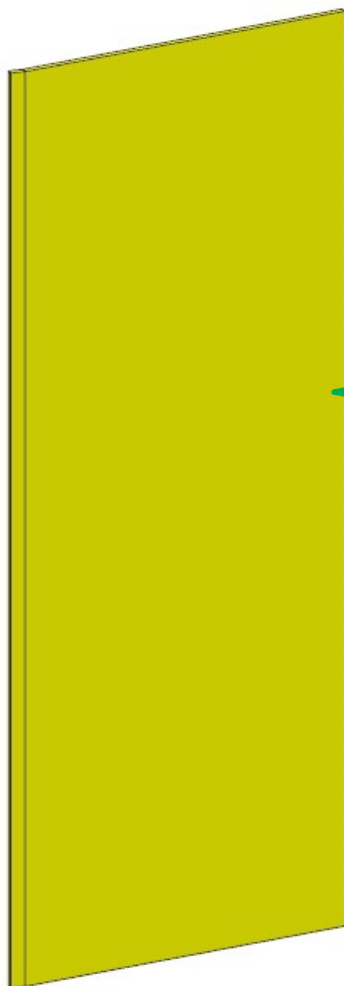

**31a**  
MODIFICATO  
COMPLETAMENTE  
PANNELLO

DETTAGLIO

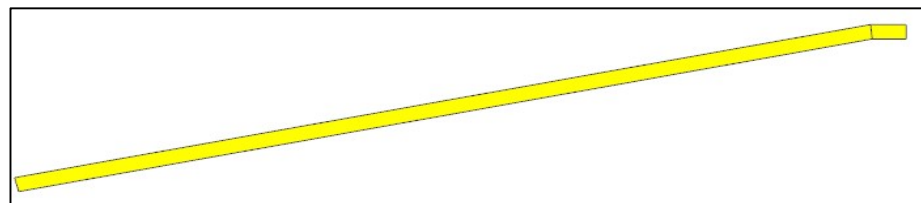

# AZ68F

DA MAT. 201

REV. 2022

LOCALE	CODICE	DESCRIZIONE COMPONENTE	FINITURA	Q.TA	OPERATORE
PARATIE	AZ68F-MF_PR24	PARETE BAGNO ARMAT. PORTA SCORR.			Damiano

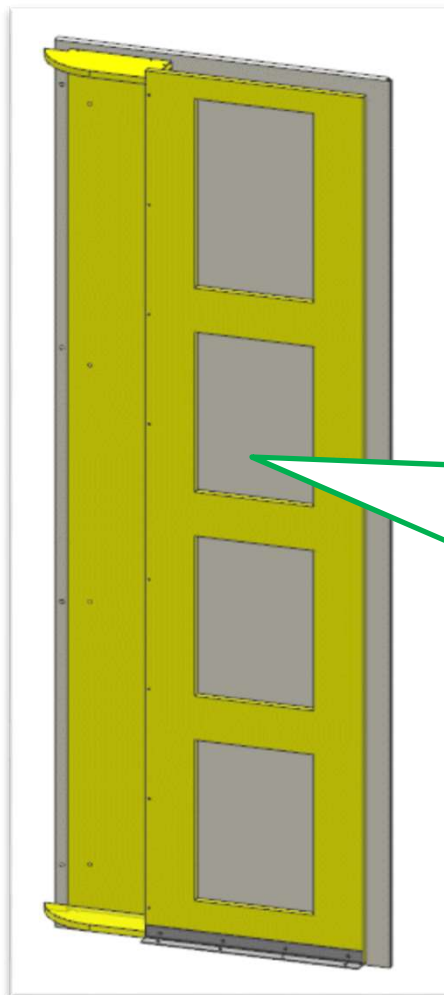

**31a**  
ALLUNGATA TUTTA LA  
STRUTTURA ED  
ELIMINATO ACCIAIO  
SUPERIORE

**FERRAMENTA:**

N° 8 - BUSSOLA ZAMA 6MA  
N° 4 -- VITI 6MA X25 TB

# AZ68F

DA MAT 233

Gennaio 2023

LOCALE	CODICE	DESCRIZIONE COMPONENTE	FINITURA	Q.TA	OPERATORE
PARATIE	AZ68F-PR24	PARETE BAGNO ARMAT. PORTA SCORR.	LAMINATO PURICELLI\ OKOUME'	2	Damiano

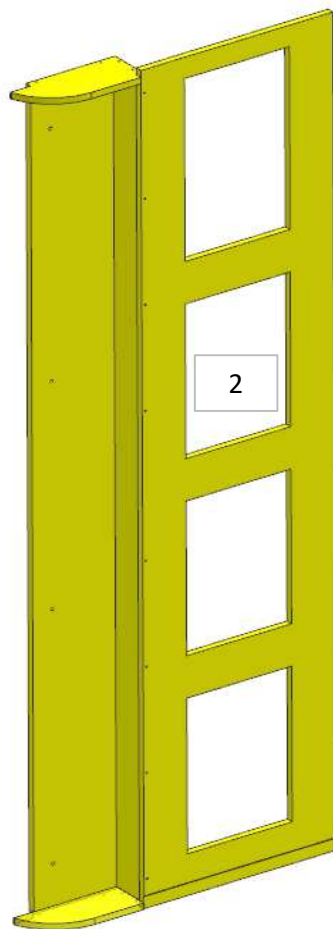
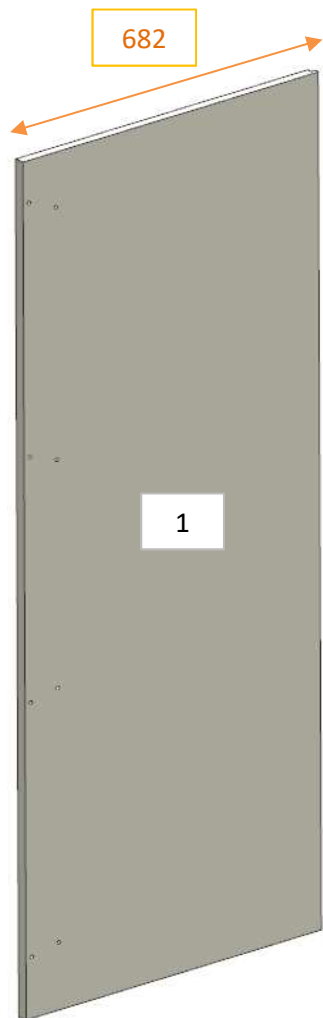

1 - L 682 x H 2024 x sp. 19  
2 - L 678 x H 1979 x pr. 104

**FERRAMENTA:**  
N° 8 - BUSSOLA ZAMA 6MA  
N° 4 -- VITI 6MA X25 TB

**31a**  
ALLUNGATA TUTTA LA

VERIFICARE PRESENZA  
SQUARCI E  
ABBASSAMENTI

ELEMENTO DA  
MONTARE con:  
**A01\_PR24**  
e spedire con un  
unico imballo

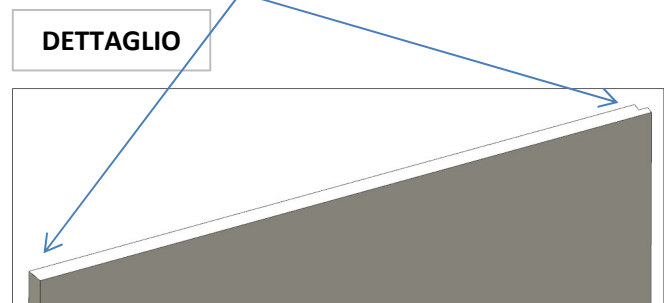
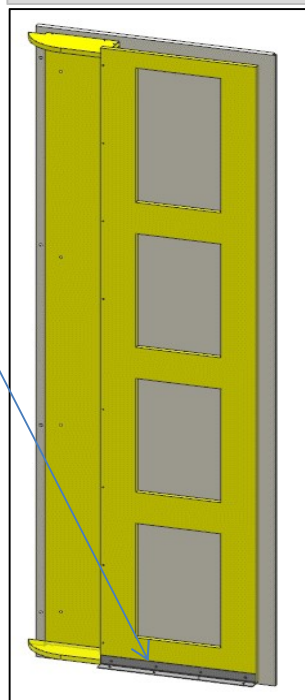

# AZ68F

DA MAT. 201

REV. 2022

LOCALE	CODICE	DESCRIZIONE COMPONENTE	FINITURA	Q.TA	OPERATORE
PARATIE	AZ68F-A01_PR24	PARETE BAGNO ARMAT. PORTA SCORR.	ACCIAIO	1	Damiano

1 - L.440 x H 30 x 30

1

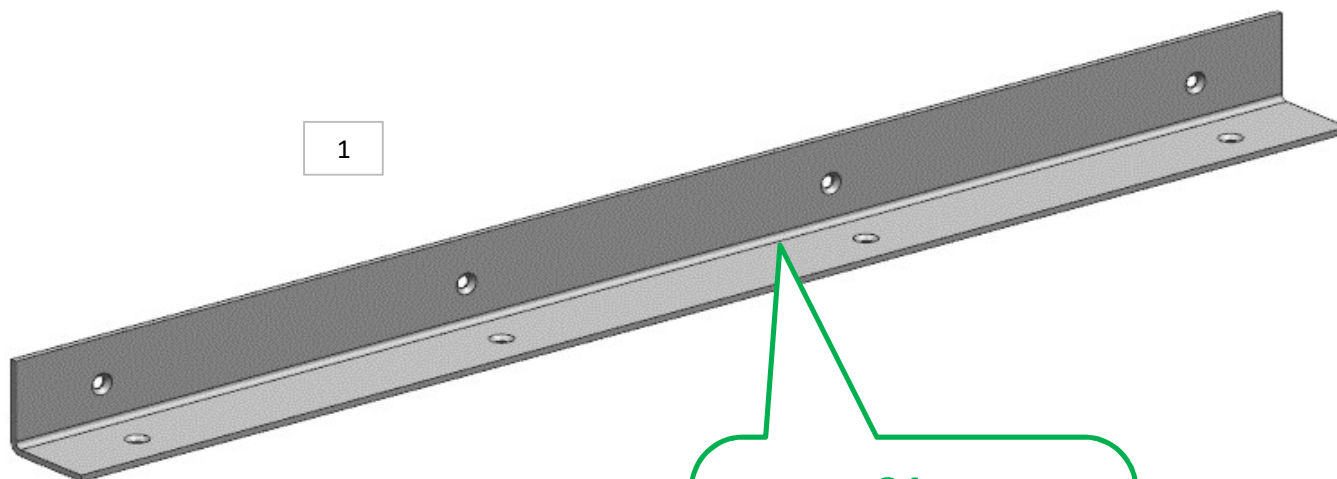

**31a**  
ELIMINATO UN  
ACCIAIO. RIMASTO  
SOLO QUELLO SOTTO

ELEMENTO DA  
MONTARE con:  
**PR24**  
e spedire con un  
unico imballo

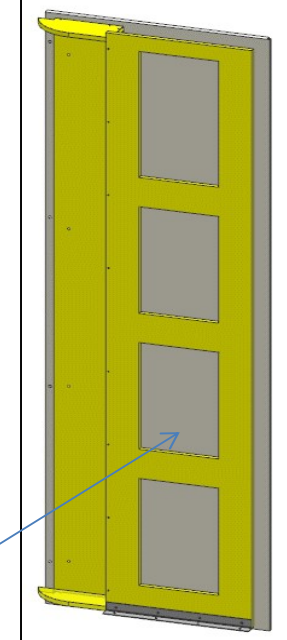

PR24

# AZ68F

DA MAT. 201

REV. 2022

LOCALE	CODICE	DESCRIZIONE COMPONENTE	FINITURA	Q.TA	OPERATORE
PARATIE	AZ68F-I01_PR24	PARETE BAGNO ARMAT. PORTA SCORR.	OKOUME' GREZZO	1	Damiano

1 - SVILUPPO 792 x H 1954 x sp 12

**31a**  
MODIFICATA FORMA  
IMBOTTITO

SVILUPPO 775



consonni&c

# AZ68F

DA MAT 233

Gennaio 2023

LOCALE	CODICE	DESCRIZIONE COMPONENTE	FINITURA	Q.TA	OPERATORE
PARATIE	AZ68F-PR25	STRUT. BAGNO ARM. SEDUTA DOCCIA	OKOUME' GREZZO	1	Damiano

1 - L.783 x H 67 x 240

**31a**  
ALLUNGATA  
STRUTTURA

