

AZ68F

DA MAT 233

REV. 2022

| LOCALE | CODICE | DESCRIZIONE COMPONENTE | FINITURA | Q.TA | OPERATORE |
|---------|---------------|--------------------------|----------|------|-----------|
| PARATIE | AZ68F-MF_PR01 | PARETE BAGNO OSPITI PRUA | | | Damiano |

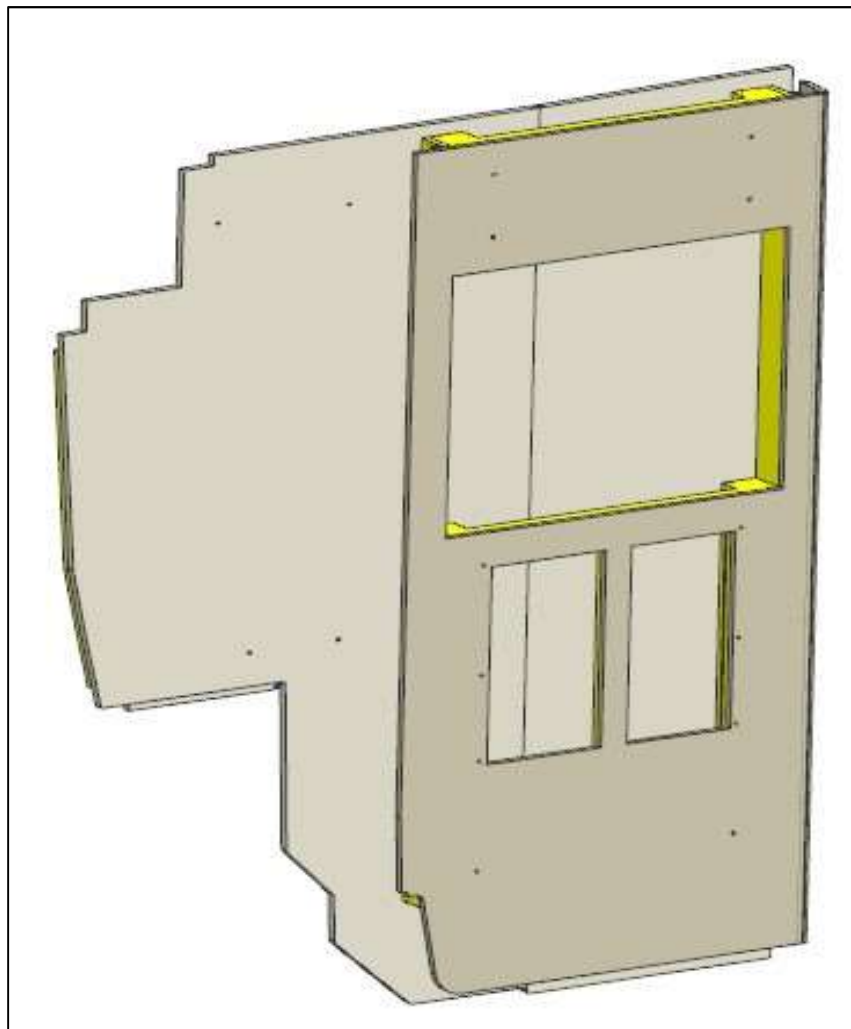

FERRAMENTA:

- N° 21 - BUSSOLA ZAMA 6MA
- N° 12 - VITI 6MA
- N° 8 - FITLOCK MASCHIO
- N° 8 - FITLOCK FEMMINA

AZ68F

DA MAT 233

Gennaio 2023

| LOCALE | CODICE | DESCRIZIONE COMPONENTE | FINITURA | Q.TA | OPERATORE |
|---------|------------|--------------------------|------------------------------------|------|-----------|
| PARATIE | AZ68F-PR01 | PARETE BAGNO OSPITI PRUA | LAMINATO RESINA\ OKOUME' GREZZO | 3 | Damiano |

ID-1685
FARE MOLTA
ATTENZIONE ALLE
STUCCATURE E
GIUNZIONI

MODIFICATA
POSIZIONE TAGLIO

CONTROLLARE
CHE QUESTO
PEZZO SIA
AVVITATO

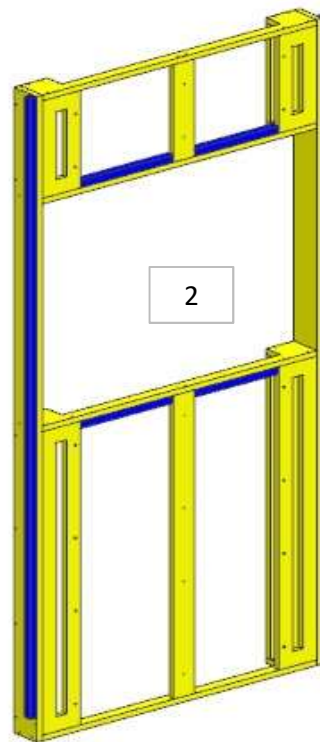
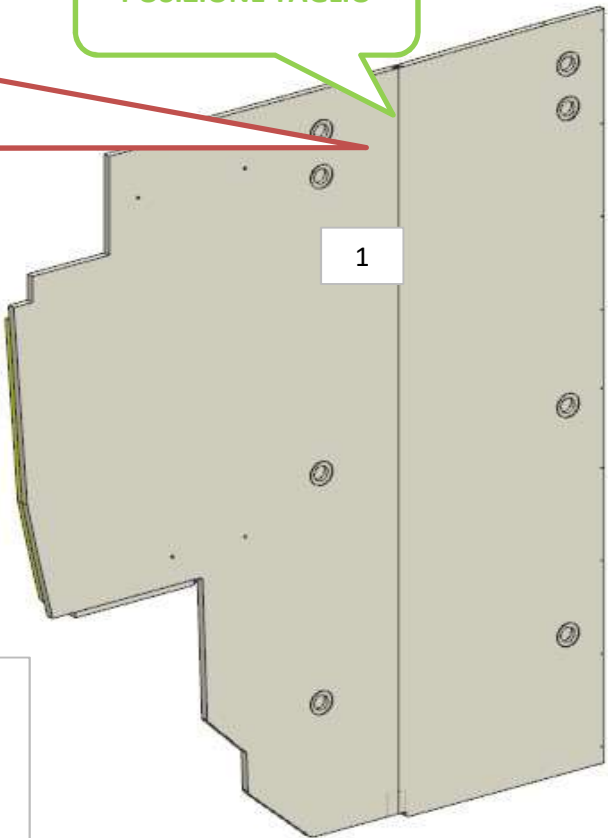

ELEMENTO DA
MONTARE con:
R01_PR01
e spedire con un unico
imballo

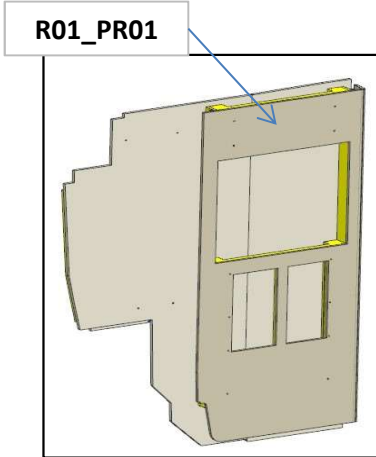

FERRAMENTA:
N° 21 - BUSSOLA ZAMA 6MA
N° 12 - VITI 6MA
N° 8 - FITLOCK MASCHIO
N° 8 - FITLOCK FEMMINA

1 - L 1712 x H.2027 x sp. 19
2 - L 866x H.1736 x pr 82
3 - L 342 x H 69 x sp.15

AZ68F

REV. 29-04-2024

| LOCALE | CODICE | DESCRIZIONE COMPONENTE | FINITURA | Q.TA | OPERATORE |
|---------|----------------|--------------------------|---------------|------|-----------|
| PARATIE | AZ68F-R01_PR01 | PARETE BAGNO OSPITI PRUA | LASTRA CHIARA | 2 | Damiano |

1 - L 982 x H 1934 x sp.16
2 - L 98 x H 1934 x sp. 16

18
VERIFICARE CHE
SIANO STATI
SPIGOLATI GLI
ANGOLI

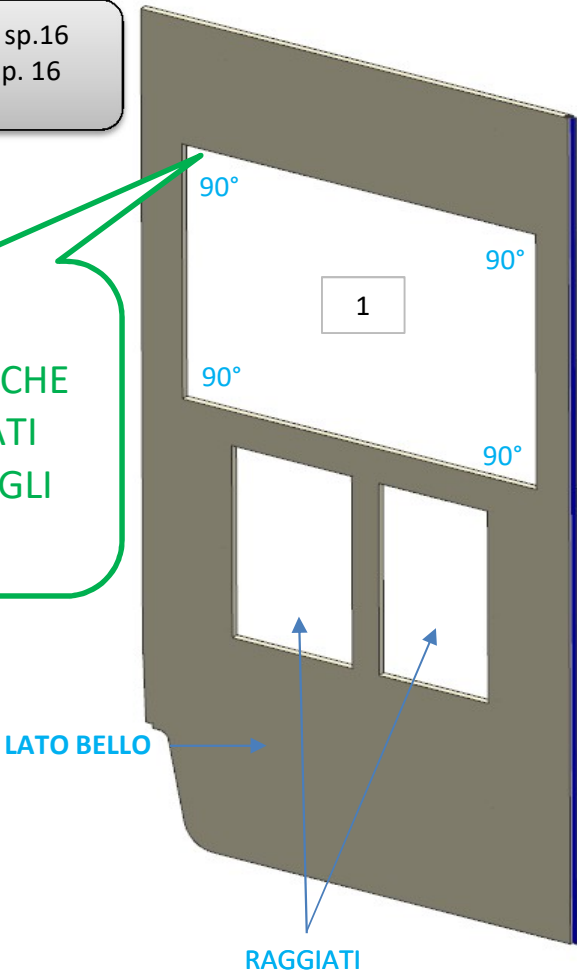

2
DB-154
INCOLLARE

DETTAGLIO MONTATO

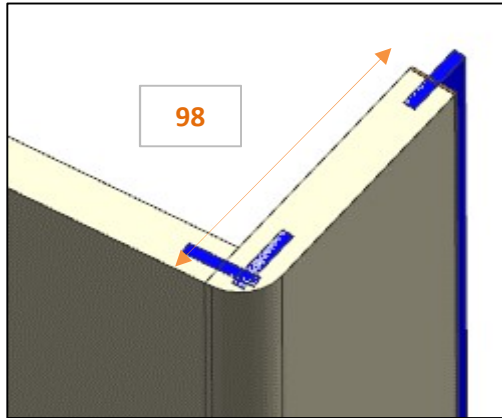

ELEMENTO DA
MONTARE con:
PR01
e spedire con un unico
imballo

PR01

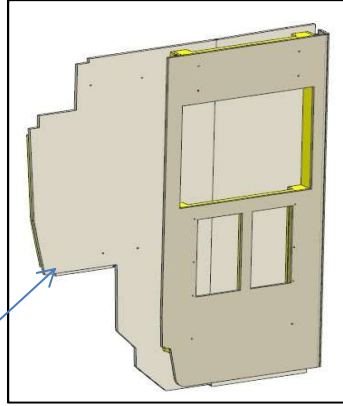

AZ68F

DA MAT 233

REV. 2022

| LOCALE | CODICE | DESCRIZIONE COMPONENTE | FINITURA | Q.TA | OPERATORE |
|---------|---------------|--------------------------------|----------|------|-----------|
| PARATIE | AZ68F-MF_PR02 | PARETE BAGNO OSPITI CENTRONAVE | | | Damiano |

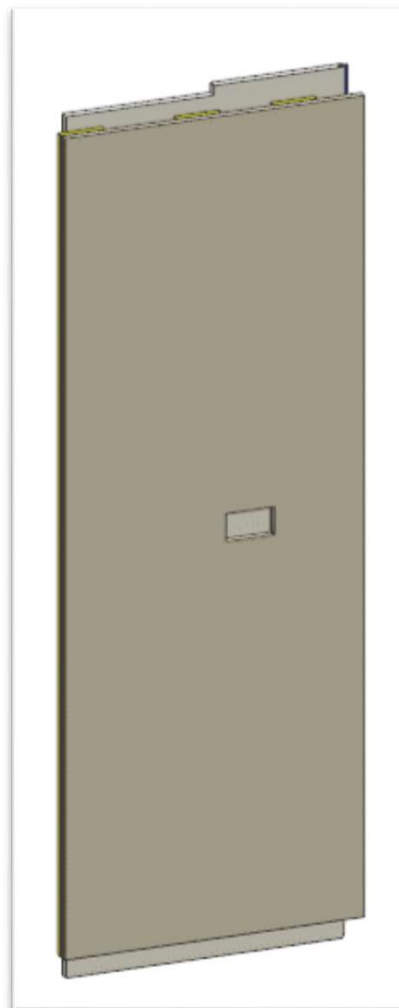

FERRAMENTA:

- N° 11 - FITLOCK MASCHIO
- N° 11 - FITLOCK FEMMINA
- N° 6 - VITI 6MA
- N° 6 - BUSSOLE ZAMA 6MA TS

AZ68F

Gennaio 2023

| LOCALE | CODICE | DESCRIZIONE COMPONENTE | FINITURA | Q.TA | OPERATORE |
|---------|------------|--------------------------------|-----------------------------|------|-----------|
| PARATIE | AZ68F-PR02 | PARETE BAGNO OSPITI CENTRONAVE | LAMINATO RESINA\ OKOUME' | 2 | Damiano |

1 - L.685 x H 2050 x sp 19
2 - L.729 x H 2075 x sp 19

1

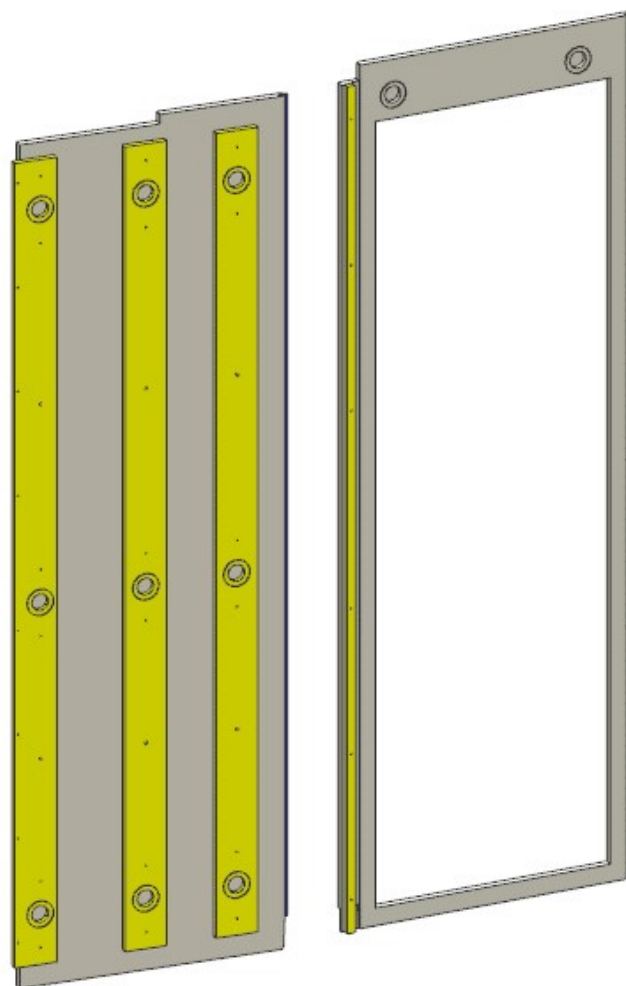

2

ELEMENTO DA
MONTARE con:
R01_PR02
e spedire con un
unico imballo

FERRAMENTA:

N° 11 - FITLOCK MASCHIO
N° 11 - FITLOCK FEMMINA
N° 6 - VITI 6MA
N° 6 - BUSSOLE ZAMA 6MA

R01_PR02

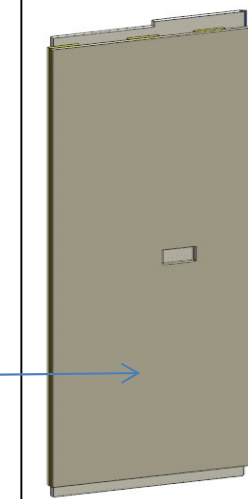

AZ68F

DA MAT 233

REV. 29-04-2024

| LOCALE | CODICE | DESCRIZIONE COMPONENTE | FINITURA | Q.TA | OPERATORE |
|---------|----------------|--------------------------------|---------------|------|-----------|
| PARATIE | AZ68F-R01_PR02 | PARETE BAGNO OSPITI CENTRONAVE | LASTRA CHIARA | 1 | Damiano |

1 - L.683 x H 1934 x sp 16

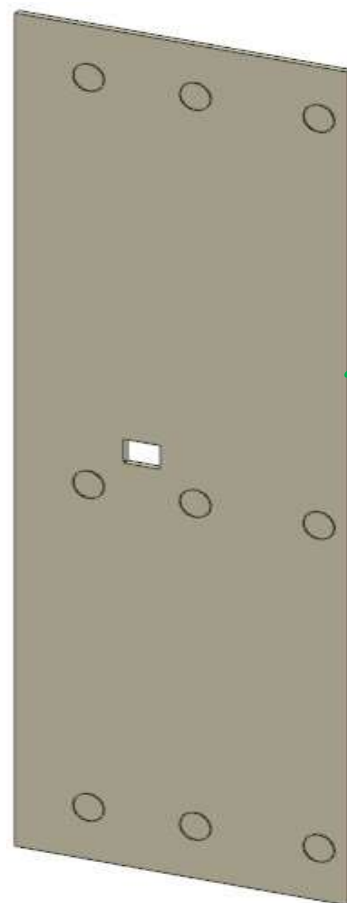

VERIFICARE
PRESENZA
BORDO

ELEMENTO DA
MONTARE con:
PR02
e spedire con un
unico imballo

PR02

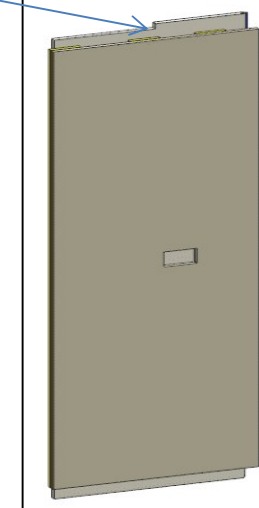

AZ68F

DA MAT. 203

REV. 2022

| LOCALE | CODICE | DESCRIZIONE COMPONENTE | FINITURA | Q.TA | OPERATORE |
|---------|----------------|--------------------------------|----------------|------|-----------|
| PARATIE | AZ68F-I01_PR02 | PARETE BAGNO OSPITI CENTRONAVE | OKOUME' GREZZO | 1 | Dante |

1 - L.620 x H.109 x sp 15

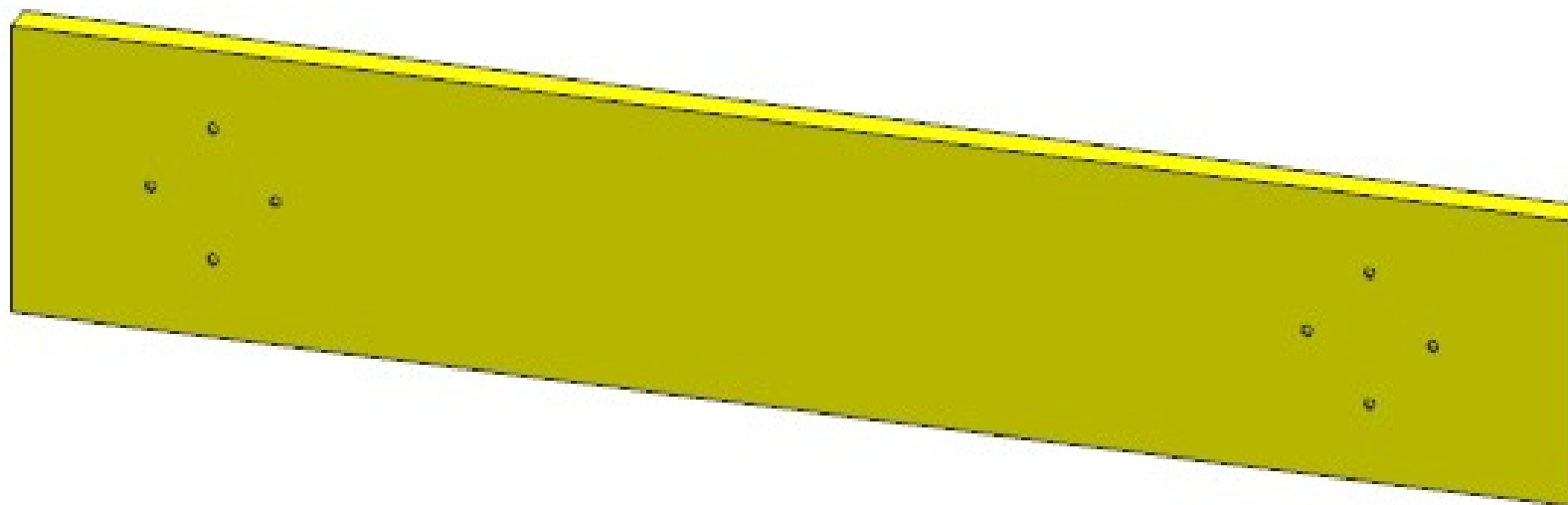

AZ68F

DA MAT 233

REV. 2022

| LOCALE | CODICE | DESCRIZIONE COMPONENTE | FINITURA | Q.TA | OPERATORE |
|---------|---------------|---------------------------|----------|------|-----------|
| PARATIE | AZ68F-MF_PR03 | PARETE BAGNO OSPITI POPPA | | | Damiano |

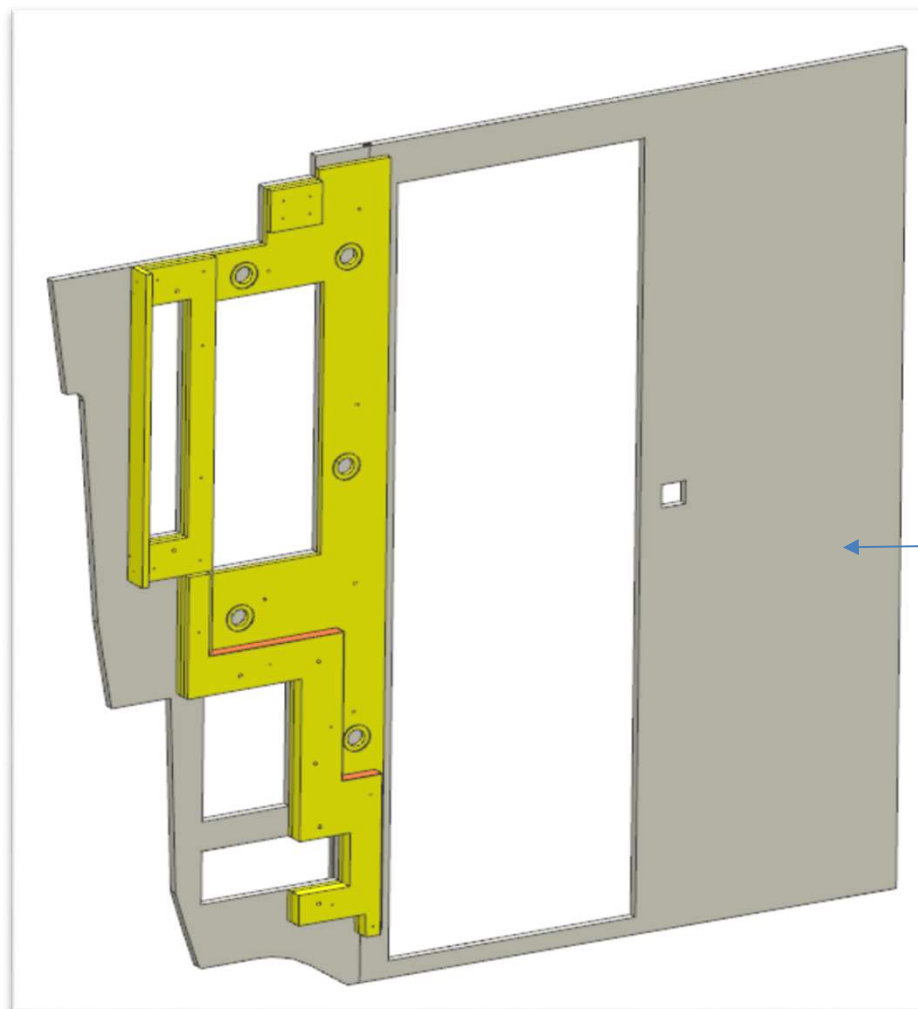

FERRAMENTA:

FERRAMENTA:

- N° 5 - FITLOCK FEMMINA
- N° 21 - BUSSOLA ZAMA 6MA
- N° 2 - SPINE 8x20 mm
- N° 7 - VITI 6MA X25 TS

AZ68F

DA MAT 233

Gennaio 2023

| LOCALE | CODICE | DESCRIZIONE COMPONENTE | FINITURA | Q.TA | OPERATORE |
|---------|------------|---------------------------|-----------------------------|------|-----------|
| PARATIE | AZ68F-PR03 | PARETE BAGNO OSPITI POPPA | LAMINATO RESINA\ OKOUME' | 2 | Damiano |

1 - L 1270 x H.2035 x sp 19

113
AGGIUNTO TAGLIO
PLACCA

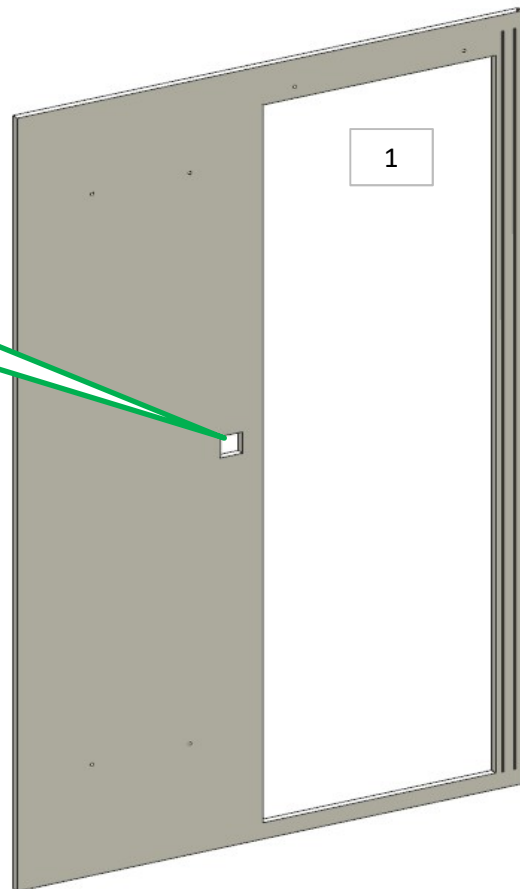

FERRAMENTA:

N° 5 - FITLOCK FEMMINA
N° 21 - BUSSOLA ZAMA 6MA
N° 2 - SPINE 8x20 mm
N° 7 - VITI 6MA X25 TS

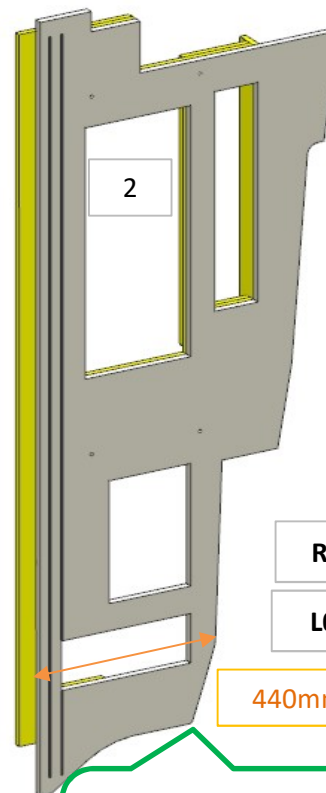

114
MODIFICA SAGOMA

ELEMENTO DA MONTARE
con:
R01_PR03
L01_PR03
e spedire con un unico
imballo

R01_PR03

L01_PR03

440mm

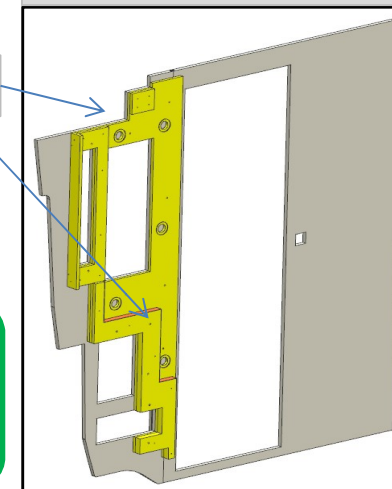

AZ68F

DA MAT 233

REV. 29-04-2024

| LOCALE | CODICE | DESCRIZIONE COMPONENTE | FINITURA | Q.TA | OPERATORE |
|---------|----------------|---------------------------|---------------|------|-----------|
| PARATIE | AZ68F-R01_PR03 | PARETE BAGNO OSPITI POPPA | LASTRA CHIARA | 2 | Damiano |

1 - L 585 x H 90 x sp 19 CON GREZZO
2 - L 120 x H 1995 x sp 19 CON GREZZO

MODIFICATE
DIMENSIONI

90

1

SPESSORARE
3 mm

2

1995

ELEMENTO DA MONTARE
con:
PR03
L01_PR03
e spedire con un unico
imballo

PR03

L01_PR03

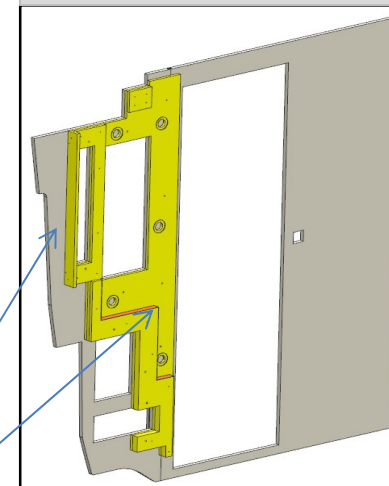

AZ68F

REV. 2022

| LOCALE | CODICE | DESCRIZIONE COMPONENTE | FINITURA | Q.TA | OPERATORE |
|---------|----------------|---------------------------|---------------------------|------|-----------|
| PARATIE | AZ68F-L01_PR03 | PARETE BAGNO OSPITI POPPA | LACCATO BRONZO (BORDO) | 1 | Damiano |

1 - L. 465 x H.955 x sp 30

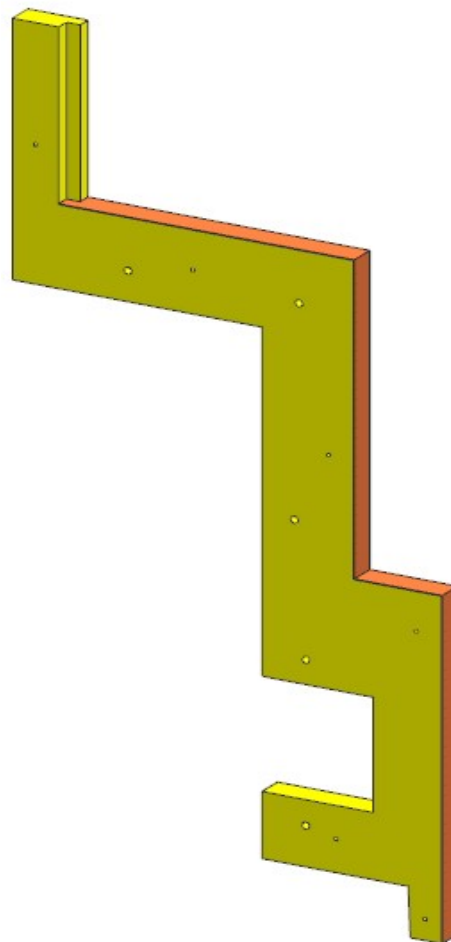

ELEMENTO DA MONTARE
con:
PR03
R01_PR03
e spedire con un unico
imballo

PR03

R01_PR03

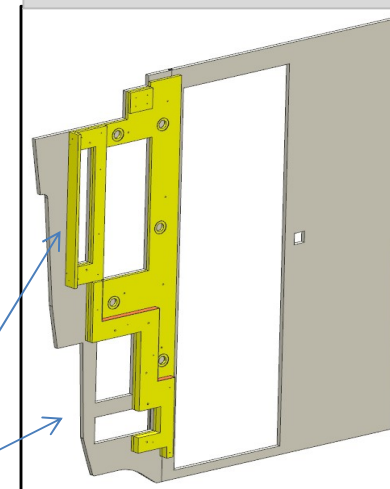

AZ68F

DA MAT. 201

REV. 2022

| LOCALE | CODICE | DESCRIZIONE COMPONENTE | FINITURA | Q.TA | OPERATORE |
|---------|---------------|------------------------|----------|------|-----------|
| PARATIE | AZ68F-MF_PR04 | PARETE BAGNO OSPITI WC | | | Damiano |

VISTA FRONTE

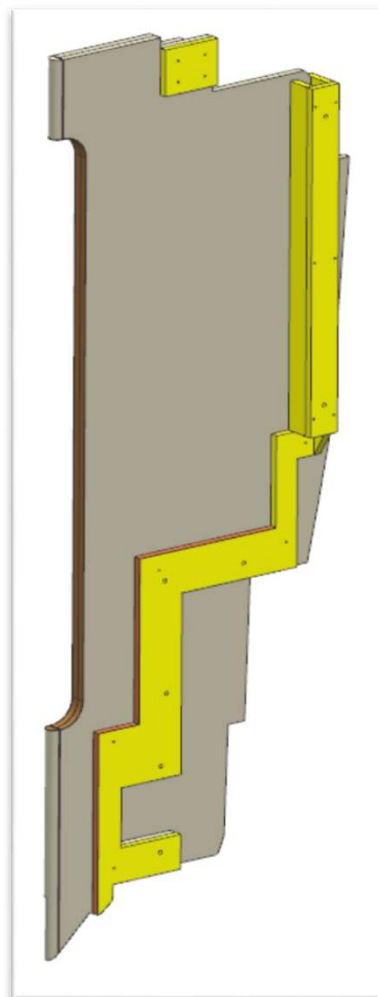

VISTA RETRO

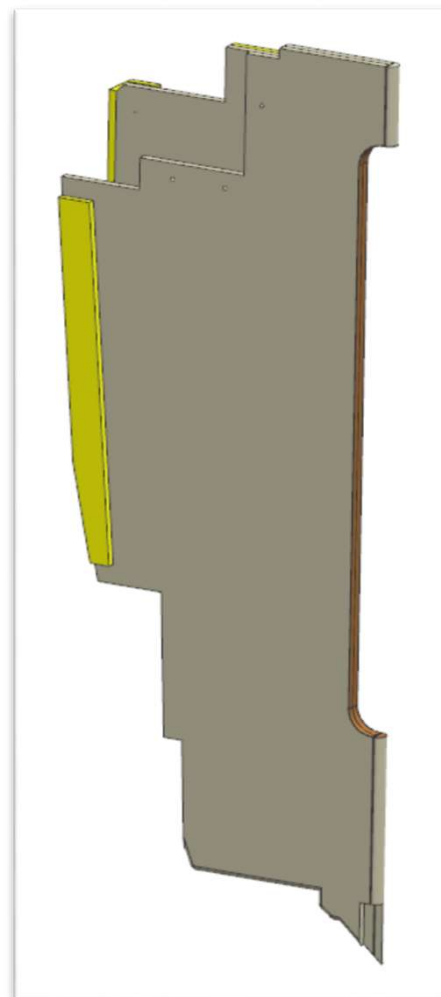

FERRAMENTA:

N° 10 - BUSSOLA ZAMA 6MA

AZ68F

Gennaio 2023

| LOCALE | CODICE | DESCRIZIONE COMPONENTE | FINITURA | Q.TA | OPERATORE |
|---------|------------|------------------------|----------------|------|-----------|
| PARATIE | AZ68F-PR04 | PARETE BAGNO OSPITI WC | OKOUME' GREZZO | 3 | Damiano |

- 1 - L 122 x H.102 x sp. 15
- 2 - L 63 x H.820 x pr. 81
- 3 - L 65 x H 784 x sp. 15

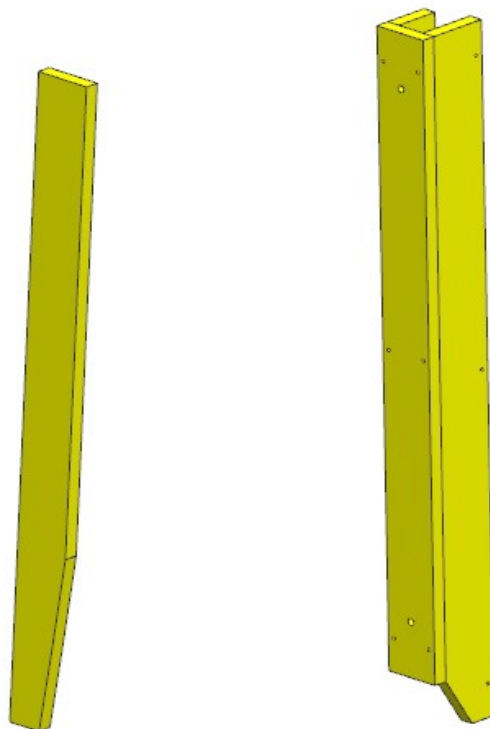
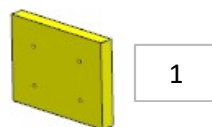

ELEMENTO DA MONTARE con:
R01_PR04
L01_PR04
e spedire con un unico imballo

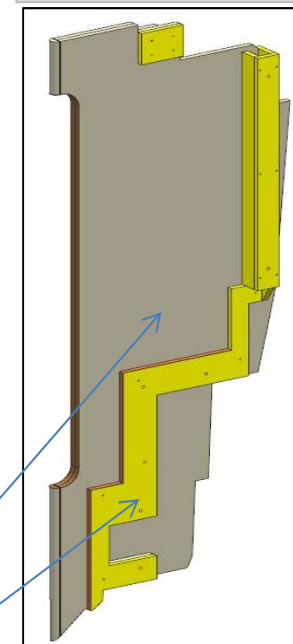

FERRAMENTA:

N° 10 - BUSSOLA ZAMA 6MA

AZ68F

DA MAT. 201 REV. 29-04-2024

| LOCALE | CODICE | DESCRIZIONE COMPONENTE | FINITURA | Q.TA | OPERATORE |
|---------|----------------|------------------------|---------------|------|-----------|
| PARATIE | AZ68F-R01_PR04 | PARETE BAGNO OSPITI WC | LASTRA CHIARA | 3 | Damiano |

1 - L 688 x H 1941 x sp 32
2 - dia. 32 x H 174
3 - dia. 32 x H 501

16
AUMENTATA
ALTEZZA

41
AUMENTATO
SCASSO

ELEMENTO DA
MONTARE con:
PR04
L01_PR04
e spedire con un
unico imballo

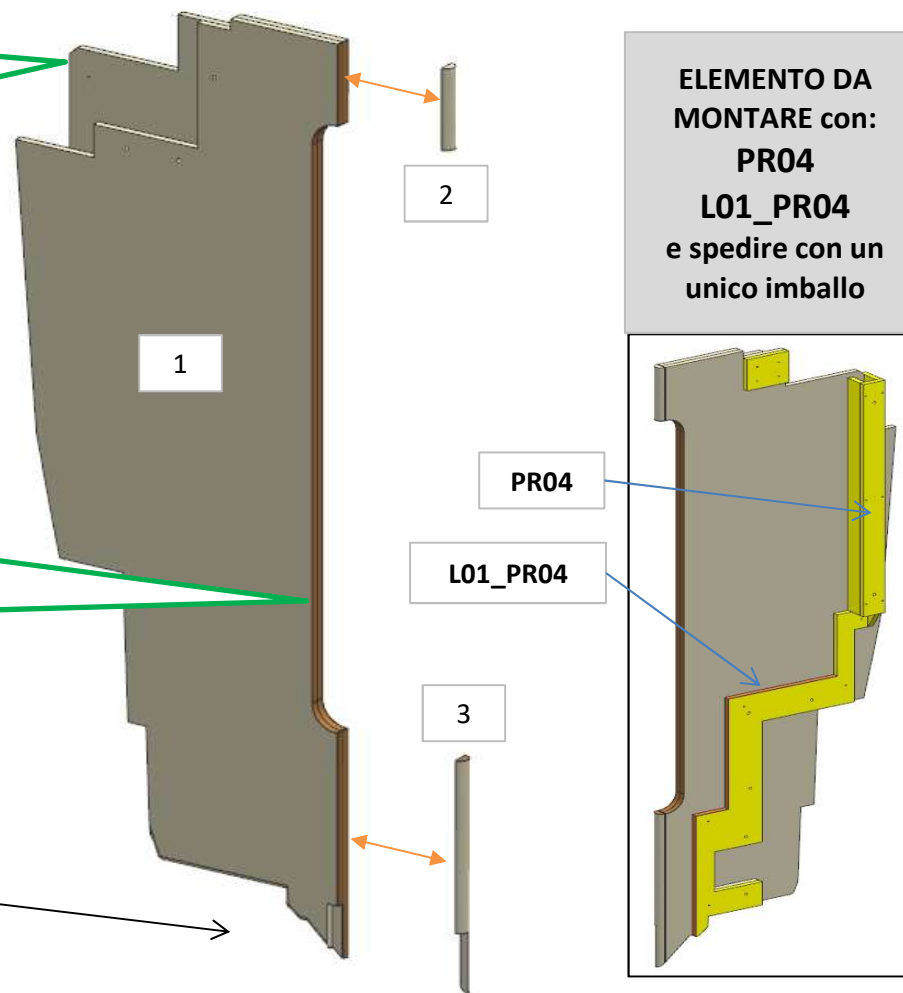
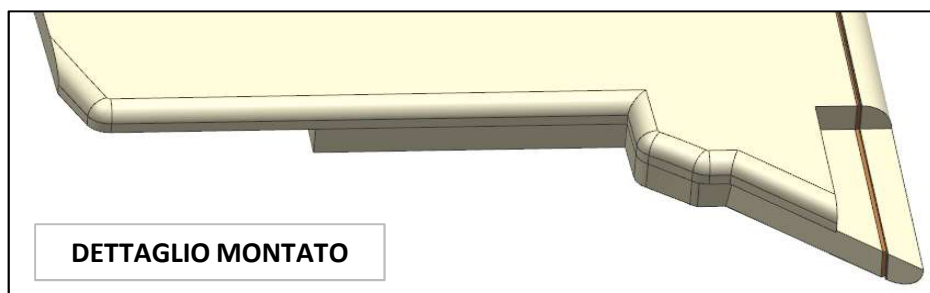

AZ68F

REV. 2022

| LOCALE | CODICE | DESCRIZIONE COMPONENTE | FINITURA | Q.TA | OPERATORE |
|---------|----------------|------------------------|---------------------------|------|-----------|
| PARATIE | AZ68F-L01_PR04 | PARETE BAGNO OSPITI WC | LACCATO BRONZO (BORDO) | 1 | Damiano |

1 - L.504 x H 957 x sp 15

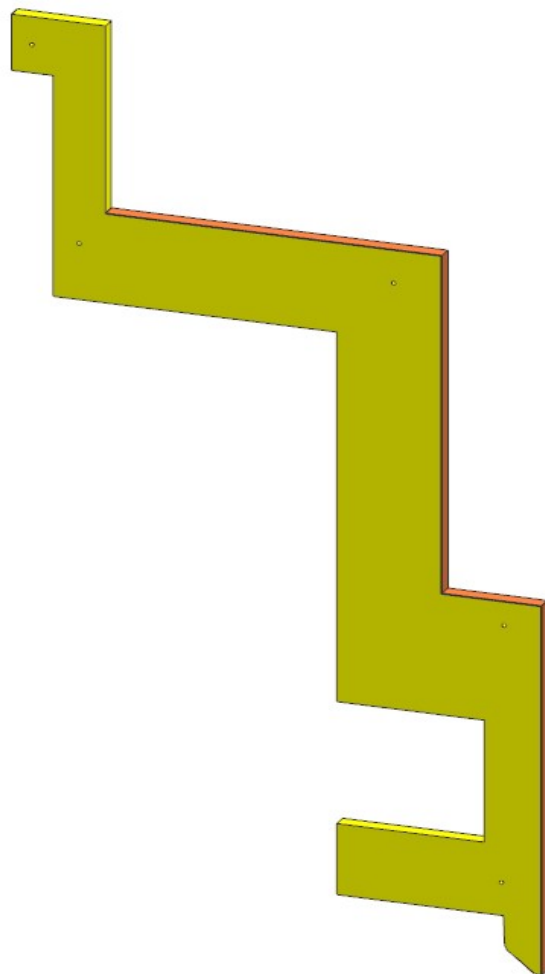

ELEMENTO DA
MONTARE con:
PR04
R01_PR04
e spedire con un
unico imballo

PR04

R01_PR04

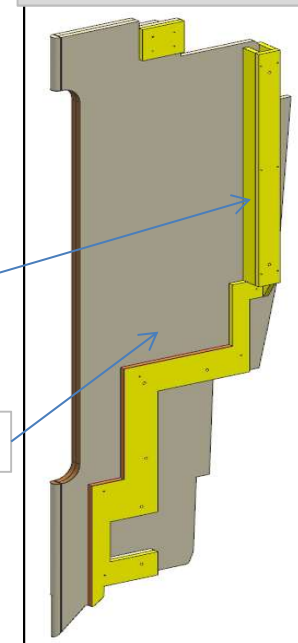

AZ68F

DA MAT 233

REV. 2022

| LOCALE | CODICE | DESCRIZIONE COMPONENTE | FINITURA | Q.TA | OPERATORE |
|---------|---------------------|------------------------|----------|------|-----------|
| PARATIE | AZ68F-MF_PR05-01\02 | PARETE BAGNO VIP PRUA | | | Damiano |

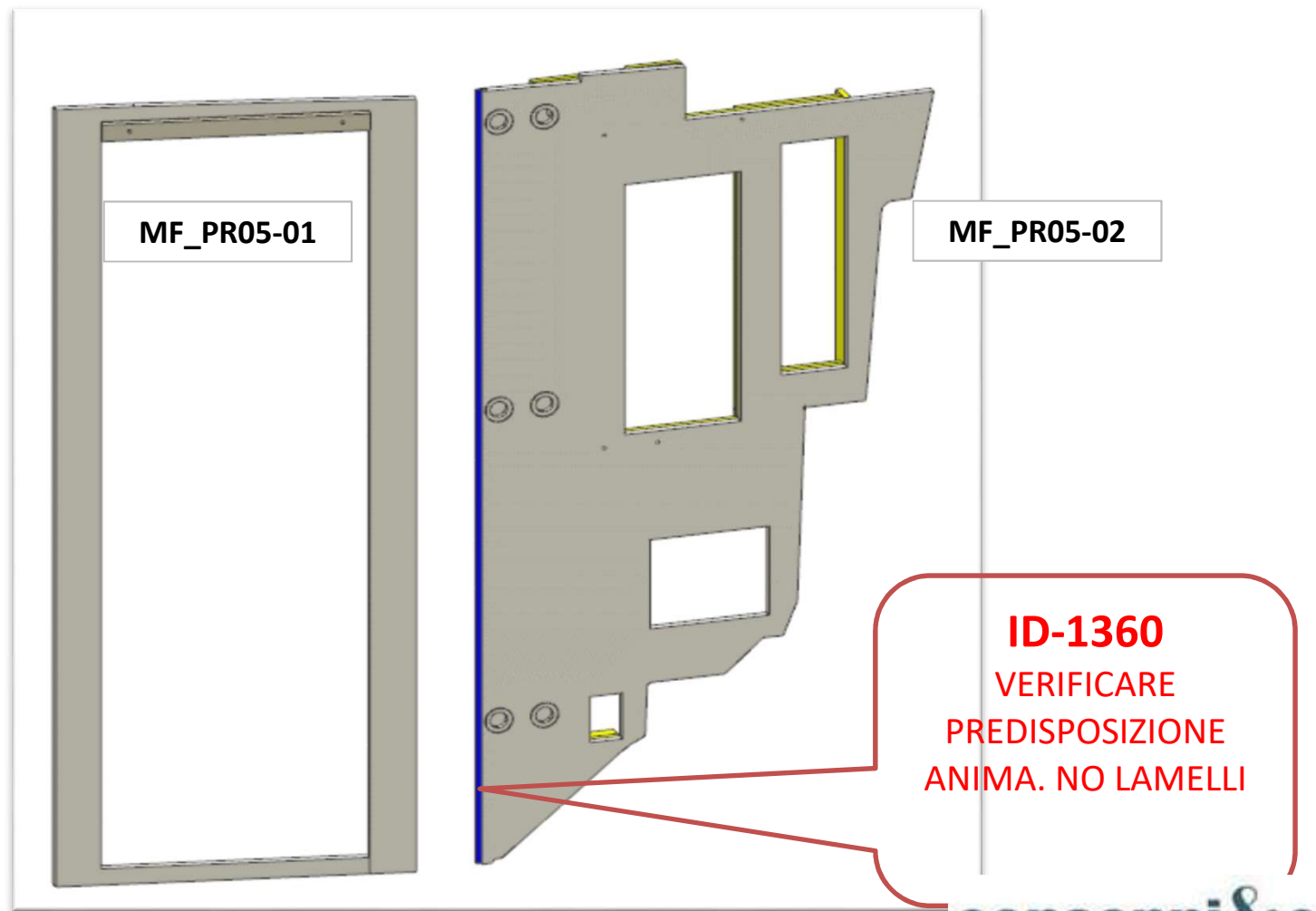

FERRAMENTA:

- N° 6 - FITLOCK MASCHIO
- N° 11 - FITLOCK FEMMINA
- N° 18 - BUSSOLA ZAMA 6MA
- N° 2 - SPINE 8x20 mm
- N° 7 - VITI 6 MA X25 TS

AZ68F

DA MAT 233

Gennaio 2023

| LOCALE | CODICE | DESCRIZIONE COMPONENTE | FINITURA | Q.TA | OPERATORE |
|---------|------------|------------------------|-----------------|------|-----------|
| PARATIE | AZ68F-PR05 | PARETE BAGNO VIP PRUA | LAMINATO RESINA | 2 | Damiano |

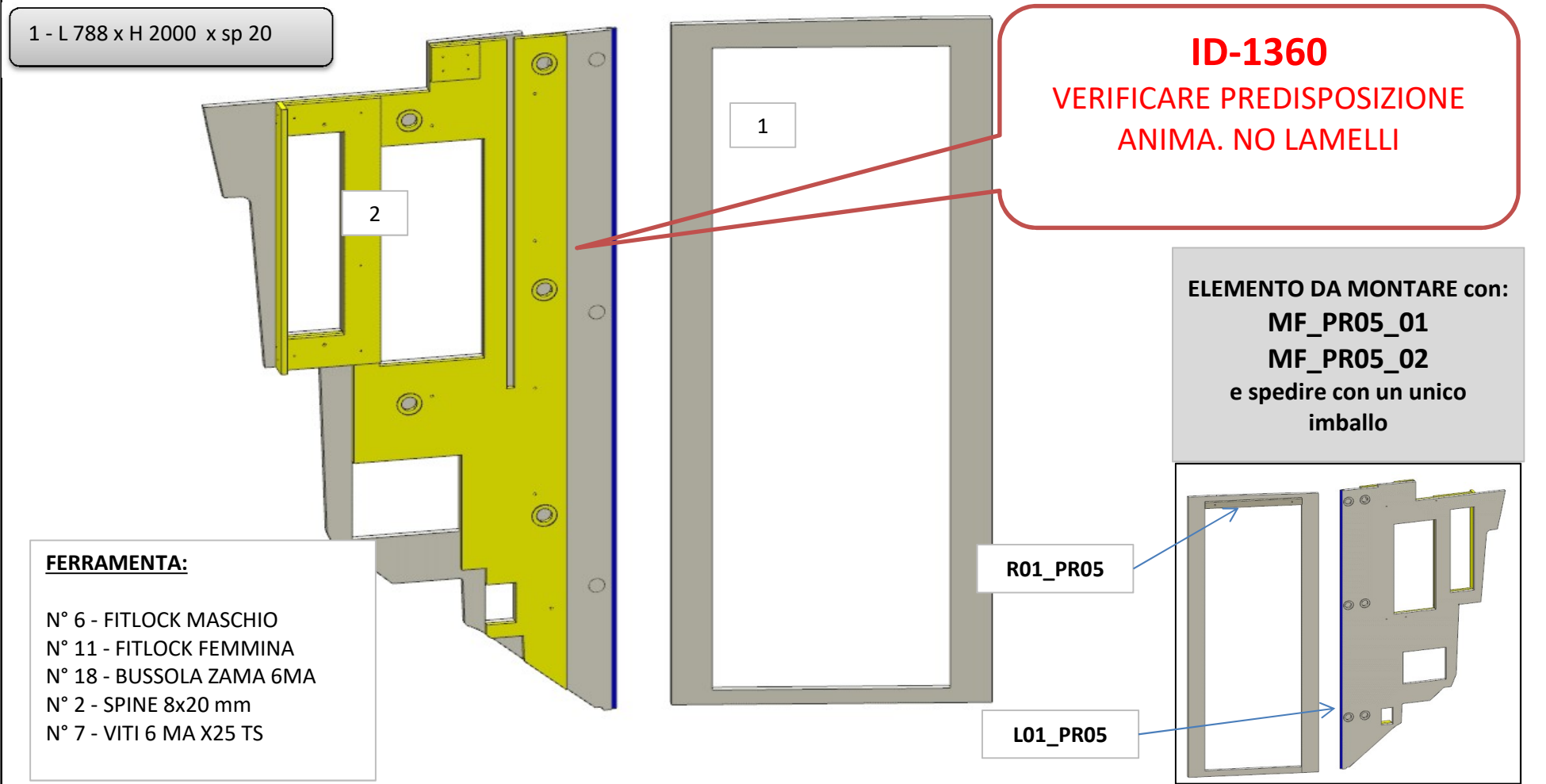

AZ68F

DA MAT 233

REV. 29-04-2024

| LOCALE | CODICE | DESCRIZIONE COMPONENTE | FINITURA | Q.TA | OPERATORE |
|---------|----------------|------------------------|---------------|------|-----------|
| PARATIE | AZ68F-R01_PR05 | PARETE BAGNO VIP PRUA | LASTRA CHIARA | 2 | Damiano |

1 - L.585 x H.44 x sp 19
2 - L.310 x H.1934 x sp 16

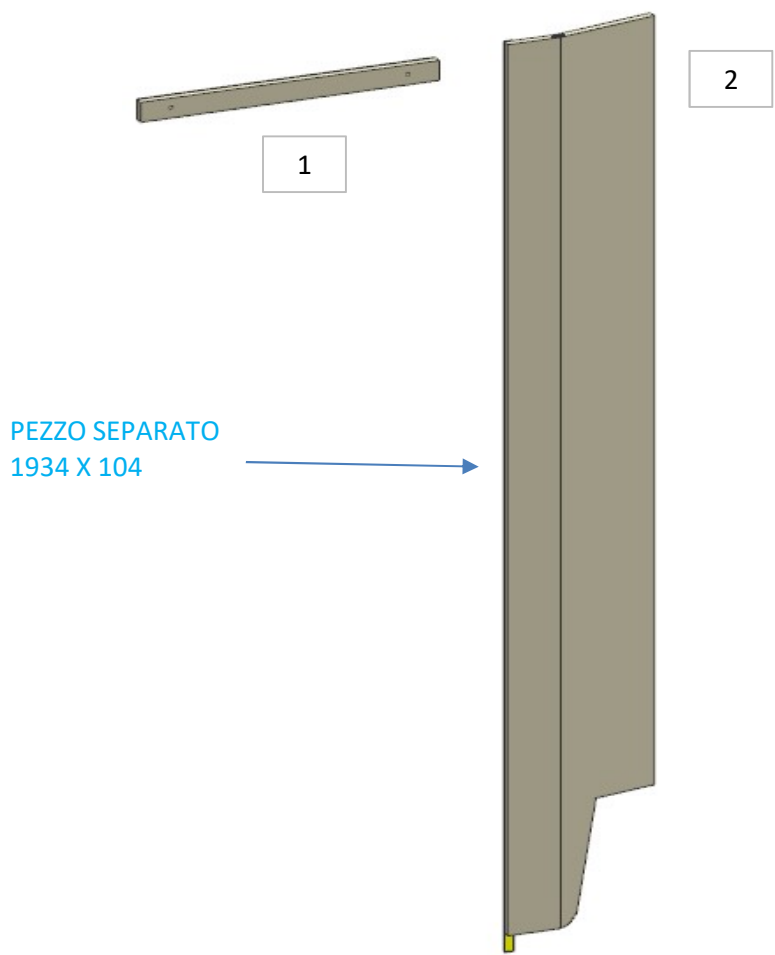

ELEMENTO R01_PR05_01 DA
MONTARE con:
MF_PR05_01
MF_PR05_02
e spedire con un unico
imballo

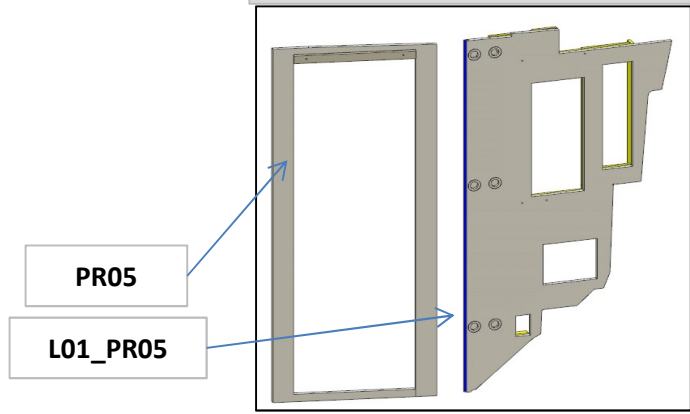

AZ68F

REV. 2022

| LOCALE | CODICE | DESCRIZIONE COMPONENTE | FINITURA | Q.TA | OPERATORE |
|---------|----------------|------------------------|---------------------------|------|-----------|
| PARATIE | AZ68F-L01_PR05 | PARETE BAGNO VIP PRUA | LACCATO BRONZO (BORDO) | 1 | Damiano |

1 - L 465 x H.960 x sp 30

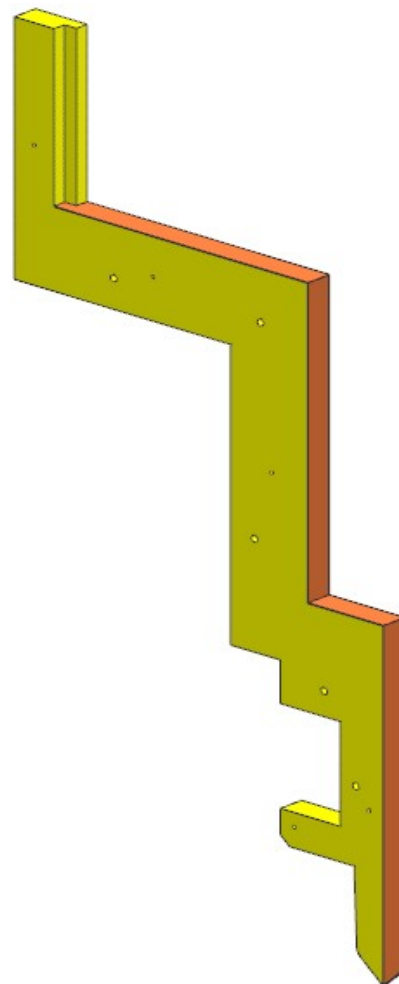

ELEMENTO DA MONTARE con:
MF_PR05_01
MF_PR05_02
e spedire con un unico
imballo

R01_PR05

PR05

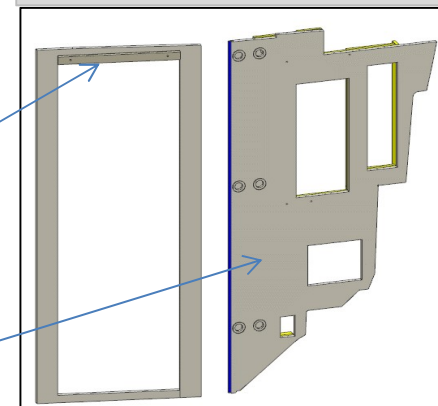

AZ68F

DA MAT 233

Gennaio 2023

| LOCALE | CODICE | DESCRIZIONE COMPONENTE | FINITURA | Q.TA | OPERATORE |
|---------|------------|------------------------|-----------------|------|-----------|
| PARATIE | AZ68F-PR06 | PARETE BAGNO VIP POPPA | LAMINATO RESINA | 1 | Damiano |

1 - L 2029 x H.2066 x sp 19

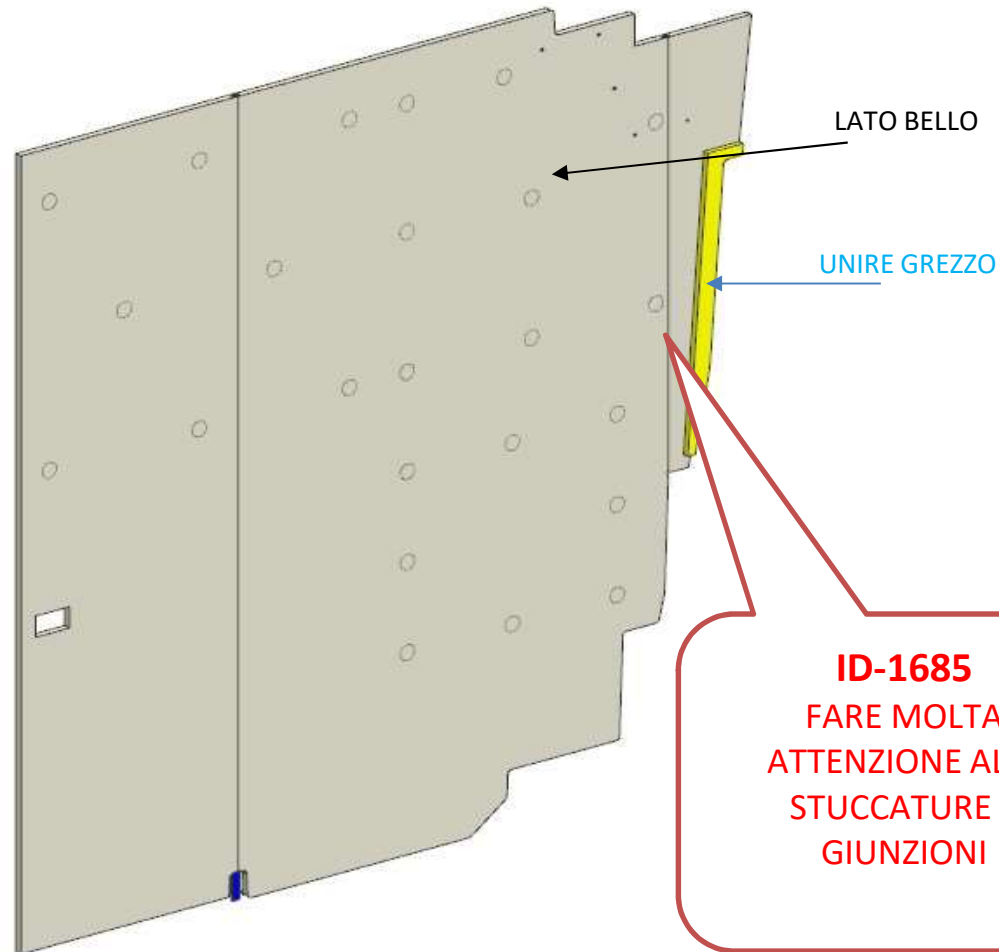
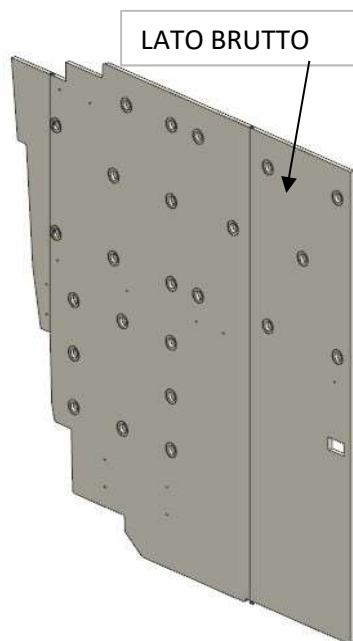

ID-1685
FARE MOLTA
ATTENZIONE ALLE
STUCCATURE E
GIUNZIONI

FERRAMENTA:

N° 24 - FITLOCK FEMMINA
N° 18 - BUSSOLA ZAMA 6MA

AZ68F

DA MAT. 201

REV. 2022

| LOCALE | CODICE | DESCRIZIONE COMPONENTE | FINITURA | Q.TA | OPERATORE |
|---------|---------------|-----------------------------|----------|------|-----------|
| PARATIE | AZ68F-MF_PR07 | PARETE BAGNO VIP CENTRONAVE | | | Damiano |

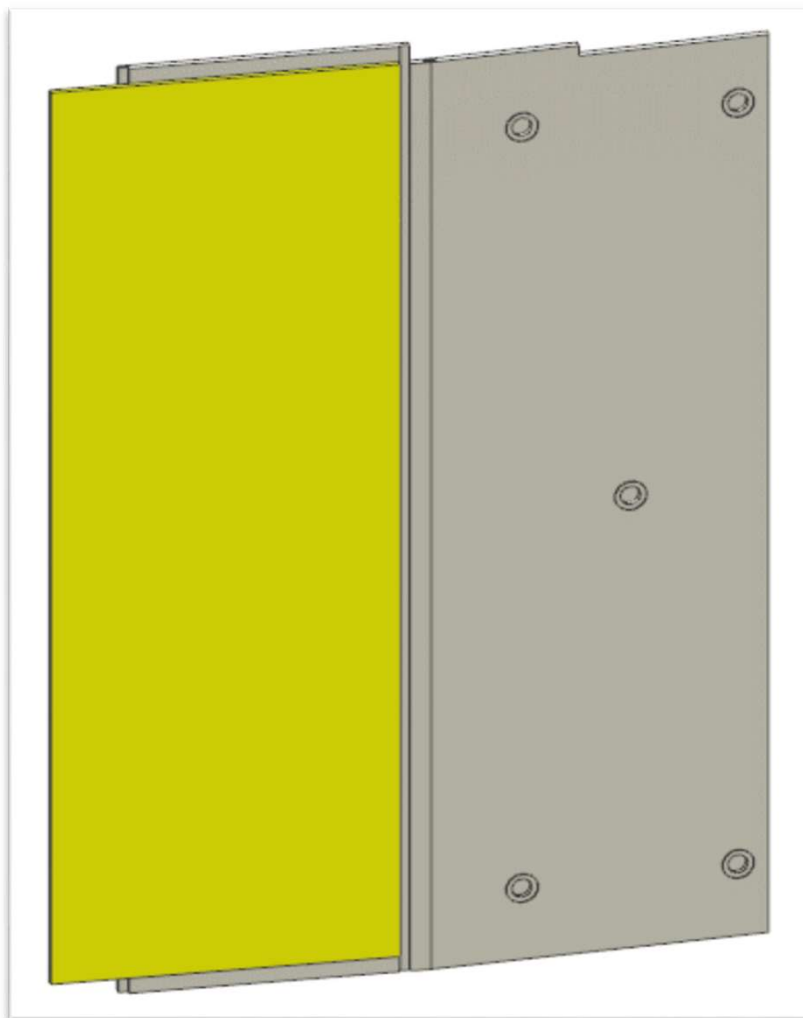

8
MONTARLE
UNITE

FERRAMENTA:

N° 13 - FITLOCK MASCHIO
N° 10 - FITLOCK FEMMINA

AZ68F

DA MAT. 201

Gennaio 2023

| LOCALE | CODICE | DESCRIZIONE COMPONENTE | FINITURA | Q.TA | OPERATORE |
|---------|------------|-----------------------------|-----------------|------|-----------|
| PARATIE | AZ68F-PR07 | PARETE BAGNO VIP CENTRONAVE | LAMINATO RESINA | 2 | Damiano |

1 - L.599 x H 2075 x sp 19
2 - L.671 x H 2035 x sp 19

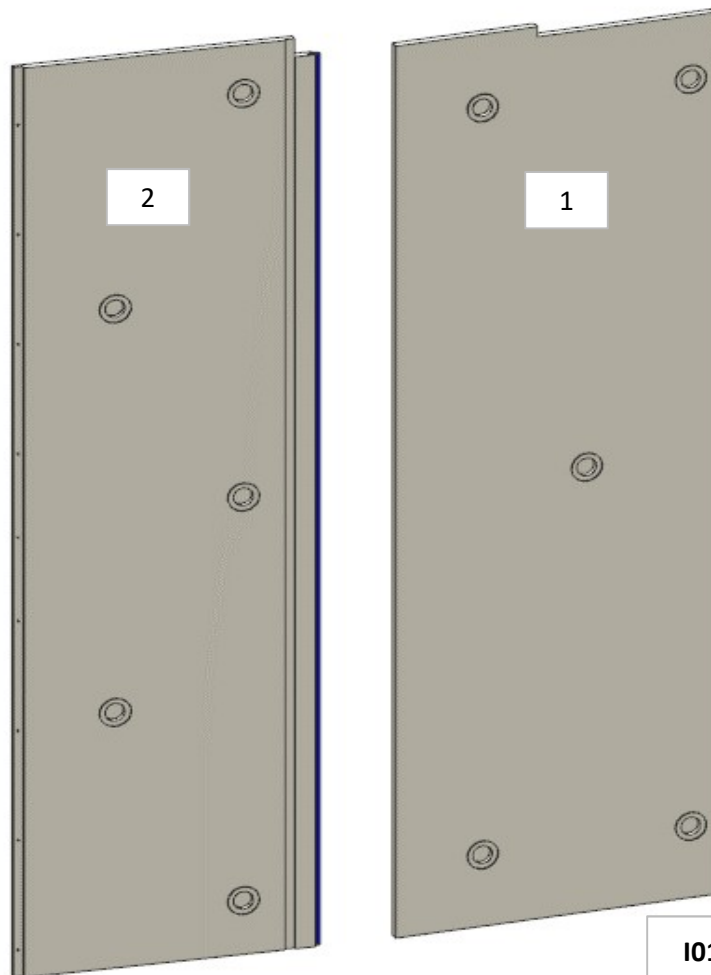

ELEMENTO DA MONTARE con:
I01_PR07
e spedire con un unico imballo

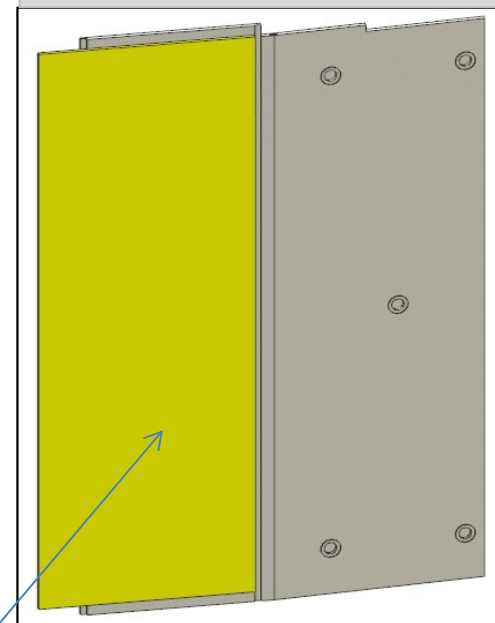

8
MONTARLE
UNITE

FERRAMENTA:

N° 13 - FITLOCK MASCHIO
N° 10 - FITLOCK FEMMINA

I01_PR07

AZ68F

DA MAT. 201

REV. 2022

| LOCALE | CODICE | DESCRIZIONE COMPONENTE | FINITURA | Q.TA | OPERATORE |
|---------|----------------|-----------------------------|----------------|------|-----------|
| PARATIE | AZ68F-I01_PR07 | PARETE BAGNO VIP CENTRONAVE | OKOUME' GREZZO | 1 | Damiano |

1 - L671 x H 2001 x sp 15

8
MONTARLE
UNITE

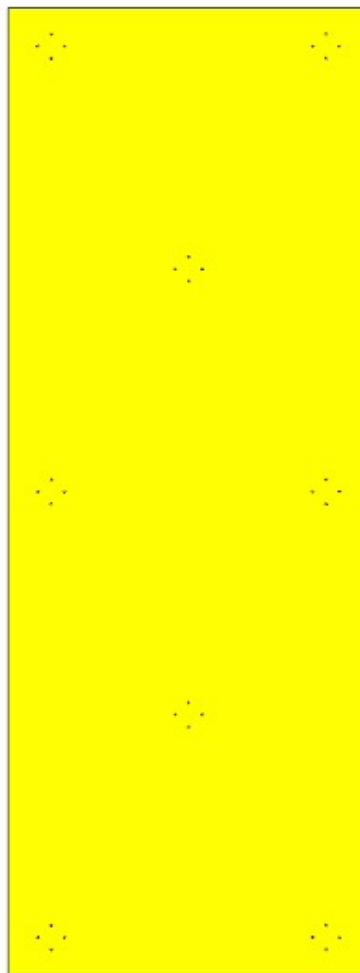

ELEMENTO DA MONTARE con:
I01_PR07
e spedire con un unico imballo

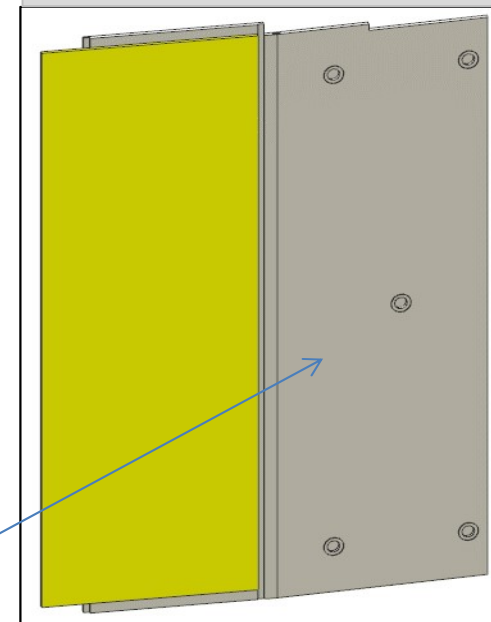

PR07

AZ68F

DA MAT 233

REV. 2022

| LOCALE | CODICE | DESCRIZIONE COMPONENTE | FINITURA | Q.TA | OPERATORE |
|---------|---------------|-----------------------------|----------|------|-----------|
| PARATIE | AZ68F-MG_PR07 | PARETE BAGNO VIP CENTRONAVE | | | Damiano |

DETTAGLIO

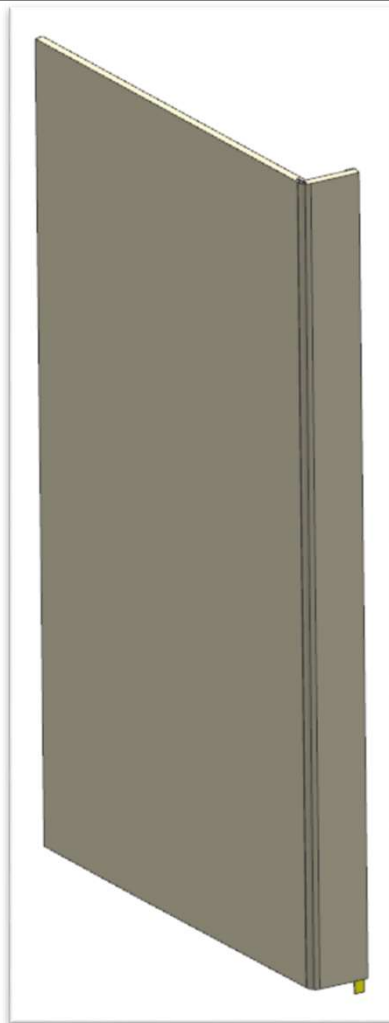
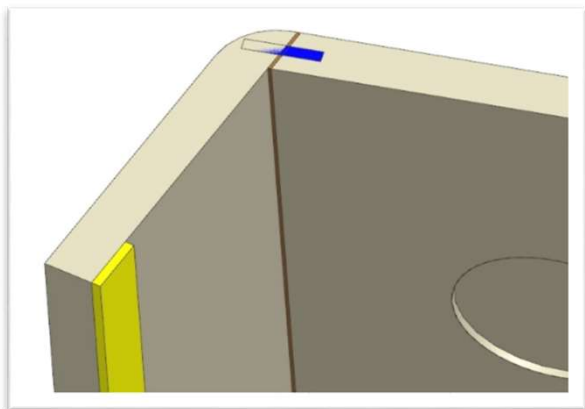

AZ68F

DA MAT 233

REV. 29-04-2024

| LOCALE | CODICE | DESCRIZIONE COMPONENTE | FINITURA | Q.TA | OPERATORE |
|---------|----------------|-----------------------------|---------------|------|-----------|
| PARATIE | AZ68F-R01_PR07 | PARETE BAGNO VIP CENTRONAVE | LASTRA CHIARA | 2 | Damiano |

- 1 - L725 x H.1933 x sp 16
- 2 - L116 x H.1933 x sp 16

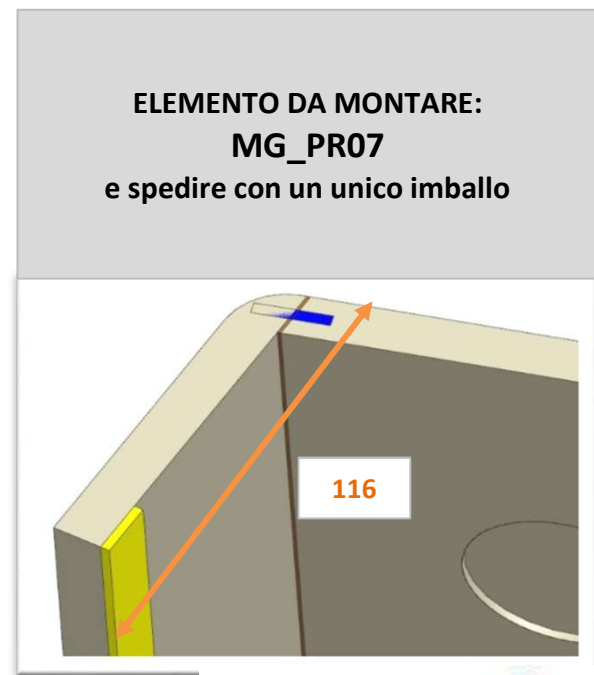
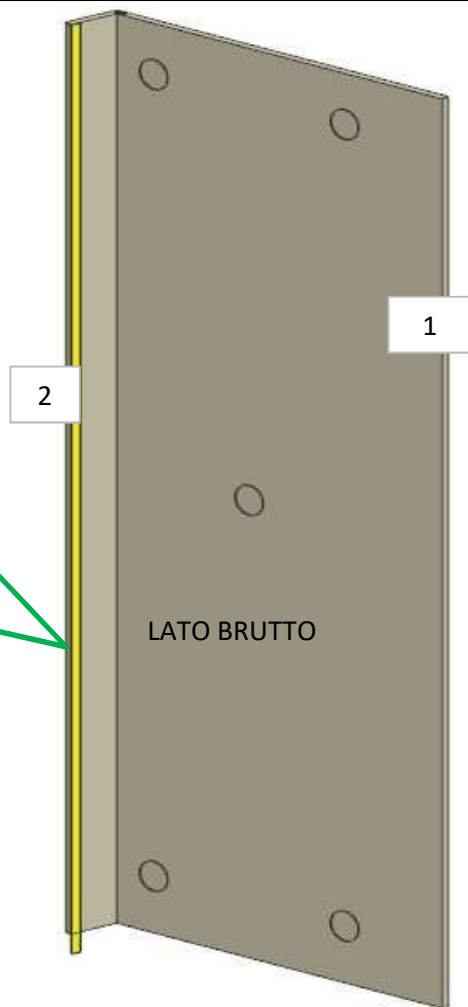

AZ68F

DA MAT. 233

REV. 2022

| LOCALE | CODICE | DESCRIZIONE COMPONENTE | FINITURA | Q.TA | OPERATORE |
|---------|---------------|--------------------------------|----------|------|-----------|
| PARATIE | AZ68F-MF_PR08 | PARETE BAGNO VIP DOCCIA_LAVABO | | | Damiano |

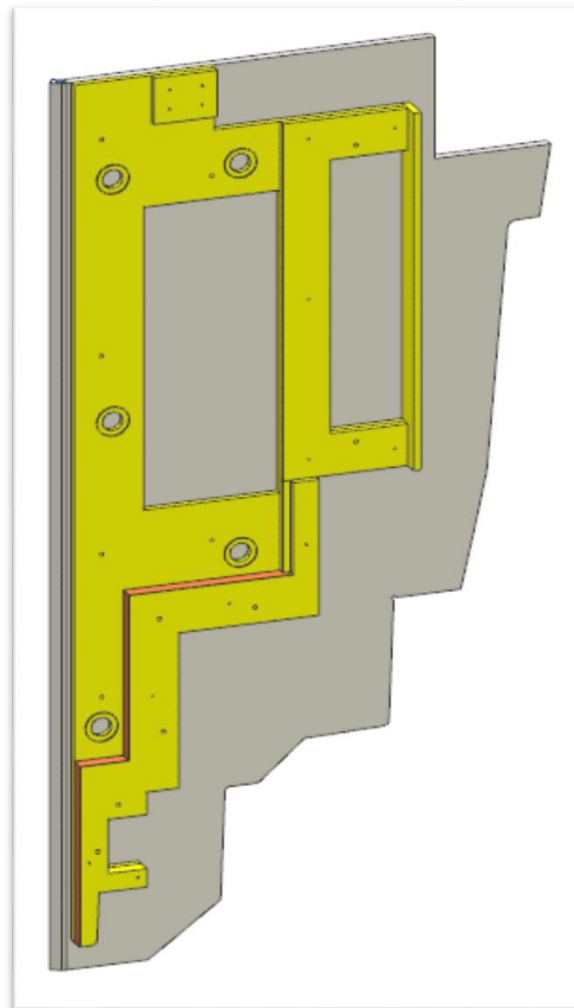

FERRAMENTA:

N° 5 - FITLOCK FEMMINA
N° 18 - BUSSOLA ZAMA 6MA
N° 6 - VITI 6MA X 25 TS

AZ68F

Gennaio 2023

| LOCALE | CODICE | DESCRIZIONE COMPONENTE | FINITURA | Q.TA | OPERATORE |
|---------|------------|--------------------------------|-----------------------------|------|-----------|
| PARATIE | AZ68F-PR08 | PARETE BAGNO VIP DOCCIA_LAVABO | LAMINATO RESINA\ OKOUME' | 1 | Damiano |

1 - L.970 x H.1942 x sp 19

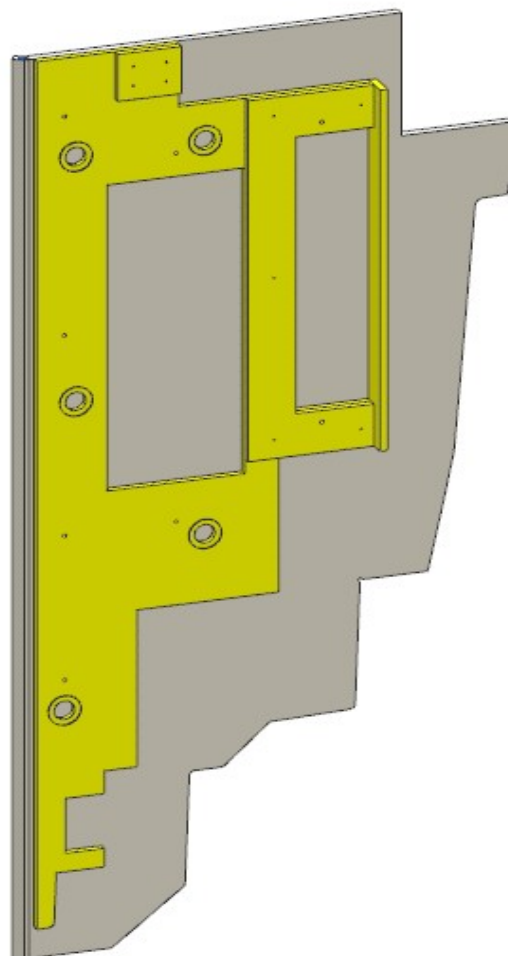

ELEMENTO DA
MONTARE con:
L01_PR08
e spedire con un
unico imballo

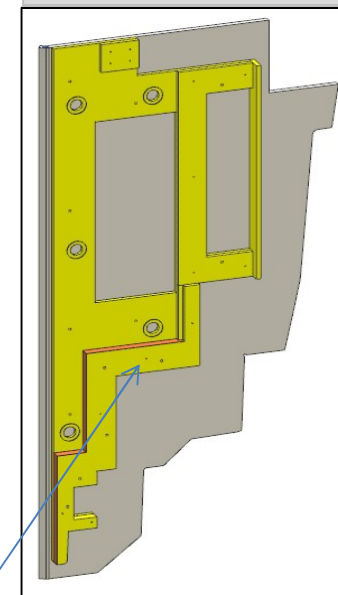

L01_PR08

FERRAMENTA:

N° 5 - FITLOCK FEMMINA
N° 18 - BUSSOLA ZAMA 6MA
N°6 VITI 6MA X25 TS

AZ68F

REV. 2022

| LOCALE | CODICE | DESCRIZIONE COMPONENTE | FINITURA | Q.TA | OPERATORE |
|---------|----------------|--------------------------------|---------------------------|------|-----------|
| PARATIE | AZ68F-L01_PR08 | PARETE BAGNO VIP DOCCIA_LAVABO | LACCATO BRONZO (BORDO) | 1 | Damiano |

1 - L 465 x H 960 x sp 30

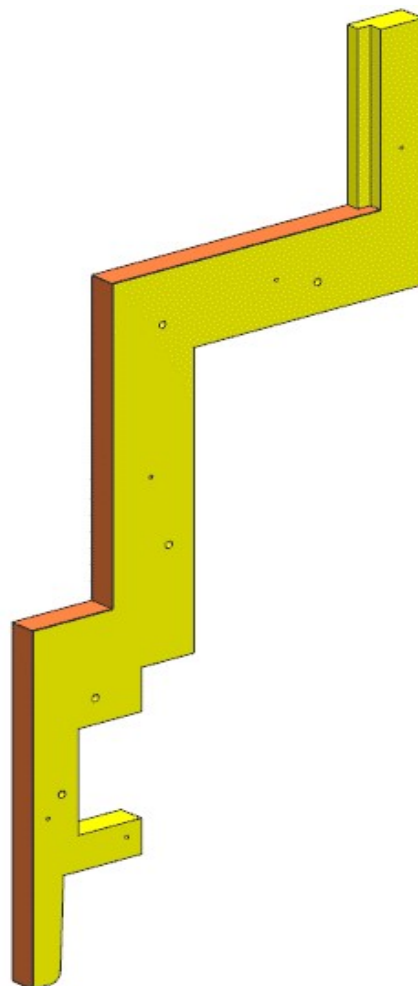

ELEMENTO DA
MONTARE con:
PR08
e spedire con un
unico imballo

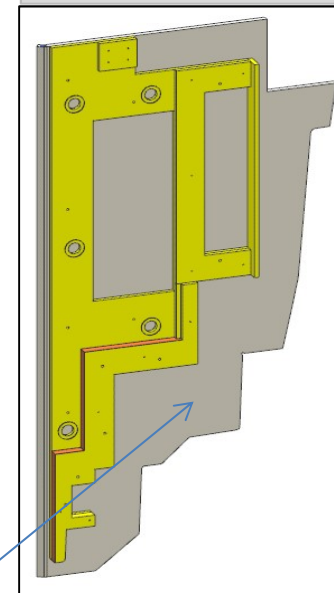

PR08

AZ68F

DA MAT. 203

REV. 2022

| LOCALE | CODICE | DESCRIZIONE COMPONENTE | FINITURA | Q.TA | OPERATORE |
|---------|---------------|----------------------------------|----------|------|-----------|
| PARATIE | AZ68F-MF_PR09 | PARETE CABINA VIP PORTA INGRESSO | | | Damiano |

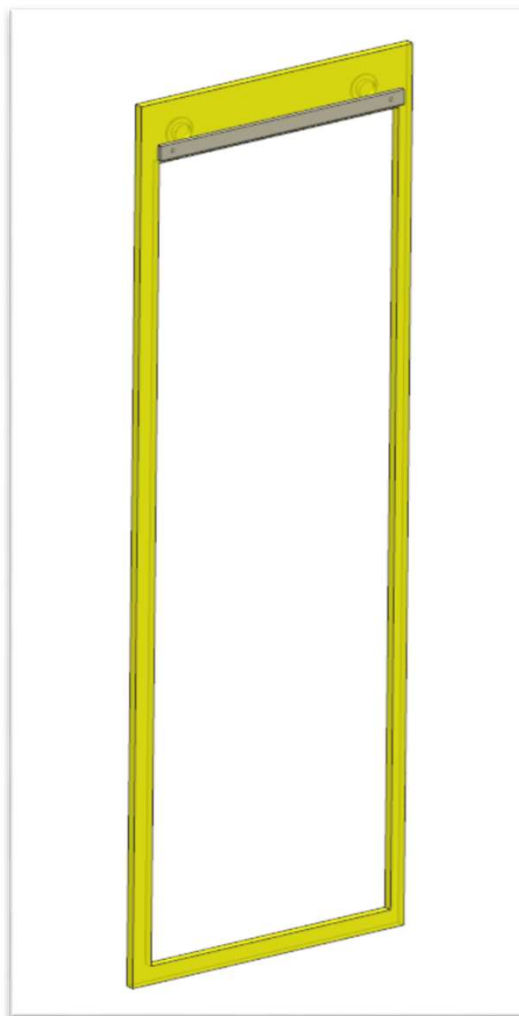

FERRAMENTA:

- N° 2 - FITLOCK MASCHIO
- N° 2 - FITLOCK FEMMINA
- N° 2 - SPINE

AZ68F

DA MAT 203

Gennaio 2023

| LOCALE | CODICE | DESCRIZIONE COMPONENTE | FINITURA | Q.TA | OPERATORE |
|---------|------------|----------------------------------|----------------|------|-----------|
| PARATIE | AZ68F-PR09 | PARETE CABINA VIP PORTA INGRESSO | OKOUME' GREZZO | 1 | Damiano |

1 - L 663 x H2075 x sp 19

DA MAT. 203 VIENE
FATTO GREZZO
(prima era in lastra)

FERRAMENTA:

N° 2 - FITLOCK MASCHIO
N° 2 - FITLOCK FEMMINA
N° 2 - SPINE

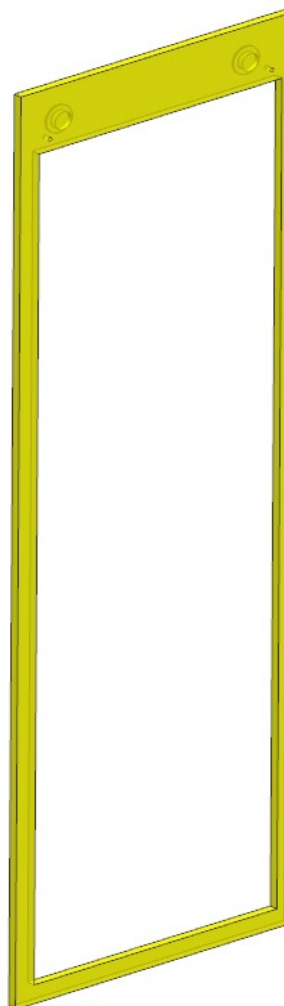

ELEMENTO DA
MONTARE con:
R01_PR09
e spedire con un
unico imballo

R01_PR09

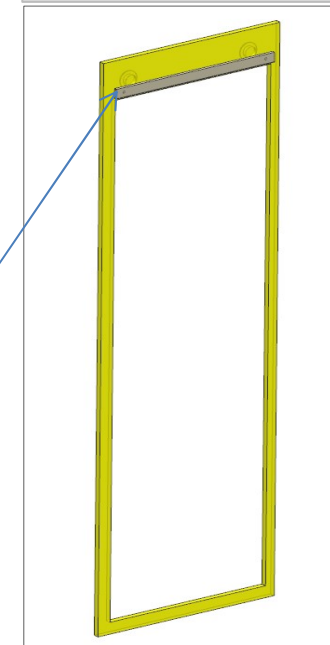

consonni&c

AZ68F

DA MAT. 203

REV. 29-04-2024

| LOCALE | CODICE | DESCRIZIONE COMPONENTE | FINITURA | Q.TA | OPERATORE |
|---------|----------------|----------------------------------|---------------|------|-----------|
| PARATIE | AZ68F-R01_PR09 | PARETE CABINA VIP PORTA INGRESSO | LASTRA CHIARA | 1 | Damiano |

1 - L.596 x H.35 x sp. 10mm

FERRAMENTA:
N° 2 - FITLOCK MASCHIO
N° 2 - FITLOCK FEMMINA
N° 2 - SPINE

VERIFICARE PRESENZA SQUARCI

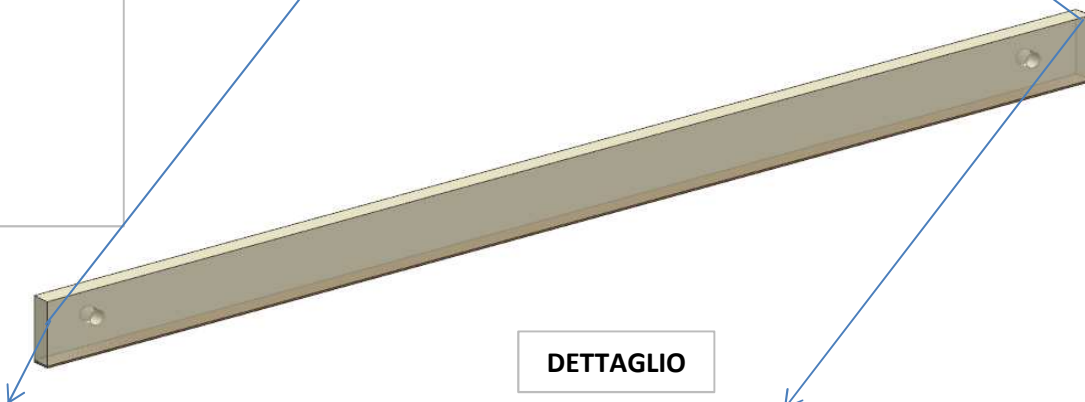

DETTAGLIO

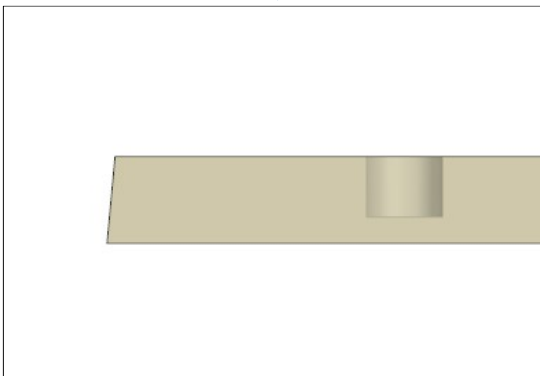

DETTAGLIO

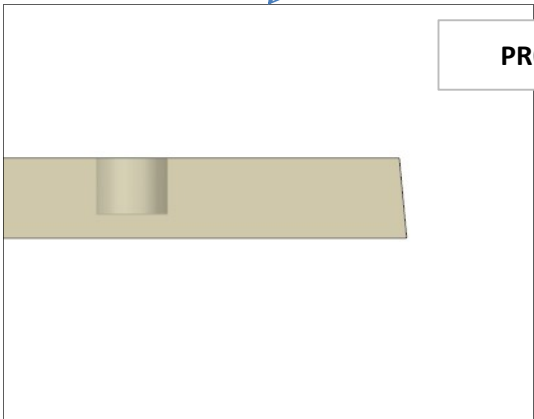

PR09

ELEMENTO DA MONTARE con:
PR09
e spedire con un unico imballo

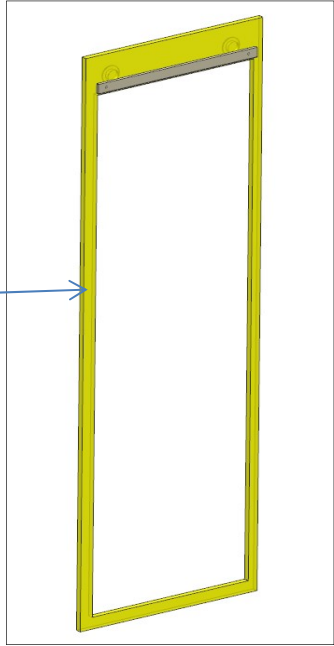

AZ68F

DA MAT 203

REV. 2022

| LOCALE | CODICE | DESCRIZIONE COMPONENTE | FINITURA | Q.TA | OPERATORE |
|---------|----------------|----------------------------------|----------------|------|-----------|
| PARATIE | AZ68F-I01_PR09 | PARETE CABINA VIP PORTA INGRESSO | OKOUME' GREZZO | 1 | Dante |

1 - L.611 x H 109 x sp 15



AZ68F

DA MAT 233

REV. 2022

| LOCALE | CODICE | DESCRIZIONE COMPONENTE | FINITURA | Q.TA | OPERATORE |
|---------|---------------|----------------------------|----------|------|-----------|
| PARATIE | AZ68F-MF_PR10 | PARETE CABINA OSPITI DX CN | | | Damiano |

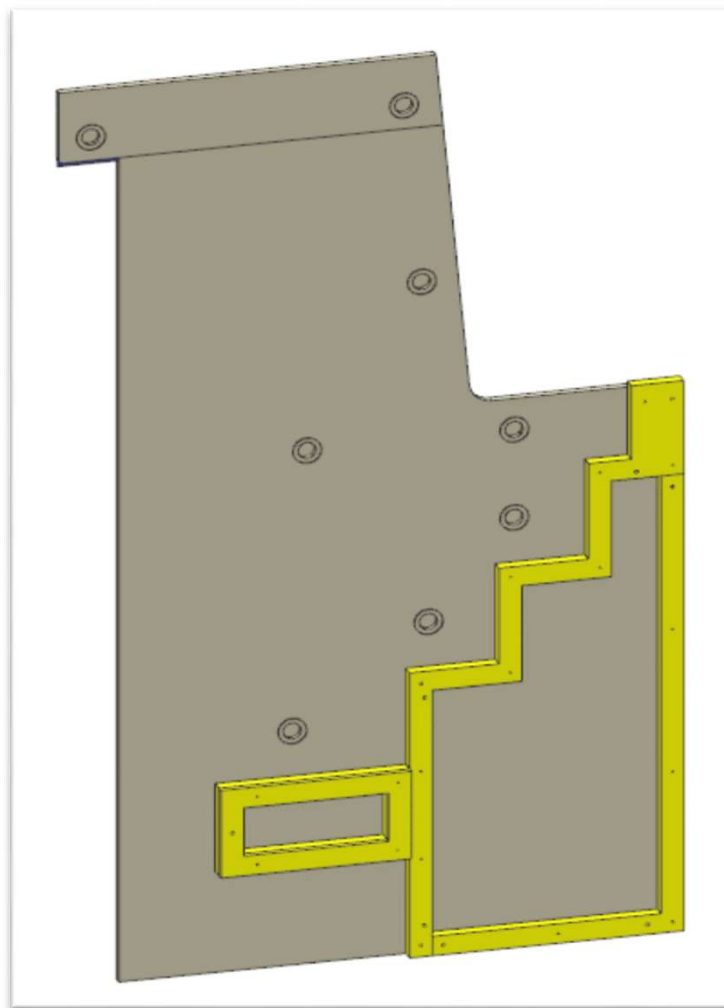

FERRAMENTA:

- N° 26 - FITLOCK MASCHIO
- N° 26 - FITLOCK FEMMINA
- N° 11 - BUSSOLA ZAMA 6MA
- N° 7 - VITI 6MA X25 TS

AZ68F

DA MAT 233

Gennaio 2023

| LOCALE | CODICE | DESCRIZIONE COMPONENTE | FINITURA | Q.TA | OPERATORE |
|---------|------------|----------------------------|----------------|------|-----------|
| PARATIE | AZ68F-PR10 | PARETE CABINA OSPITI DX CN | OKOUME' GREZZO | 2 | Damiano |

1 - L.1024 x H.1393 x sp 30
2 - L.554 x H.1157 x sp 30

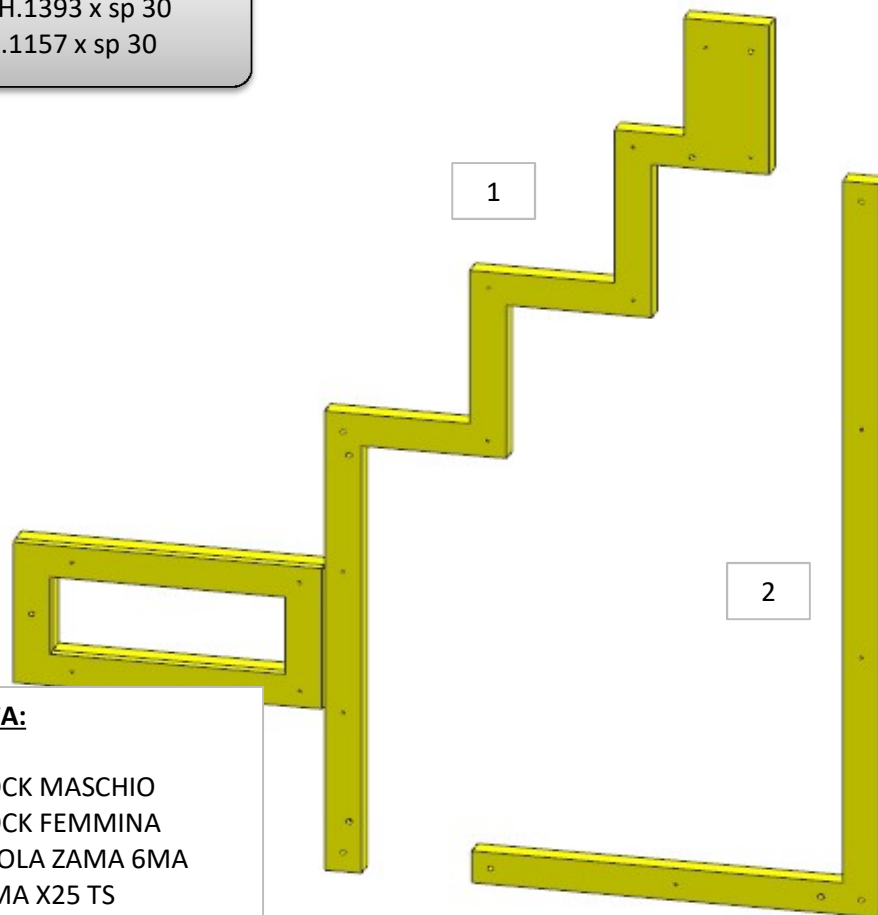

FERRAMENTA:

N° 26 - FITLOCK MASCHIO
N° 26 - FITLOCK FEMMINA
N° 11 - BUSSOLA ZAMA 6MA
N° 7 - VITI 6MA X25 TS

ELEMENTO DA
MONTARE con:
R01_PR10
e spedire con un unico
imballo

R01_PR10

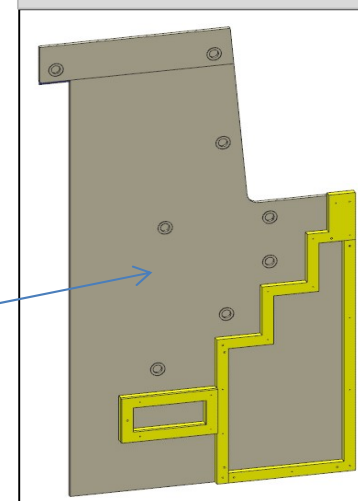

AZ68F

DA MAT 233

REV. 29-04-2024

| LOCALE | CODICE | DESCRIZIONE COMPONENTE | FINITURA | Q.TA | OPERATORE |
|---------|----------------|----------------------------|---------------|------|-----------|
| PARATIE | AZ68F-R01_PR10 | PARETE CABINA OSPITI DX CN | LASTRA CHIARA | 3 | Damiano |

ALLARGATI
TAGLI ELETTRICI

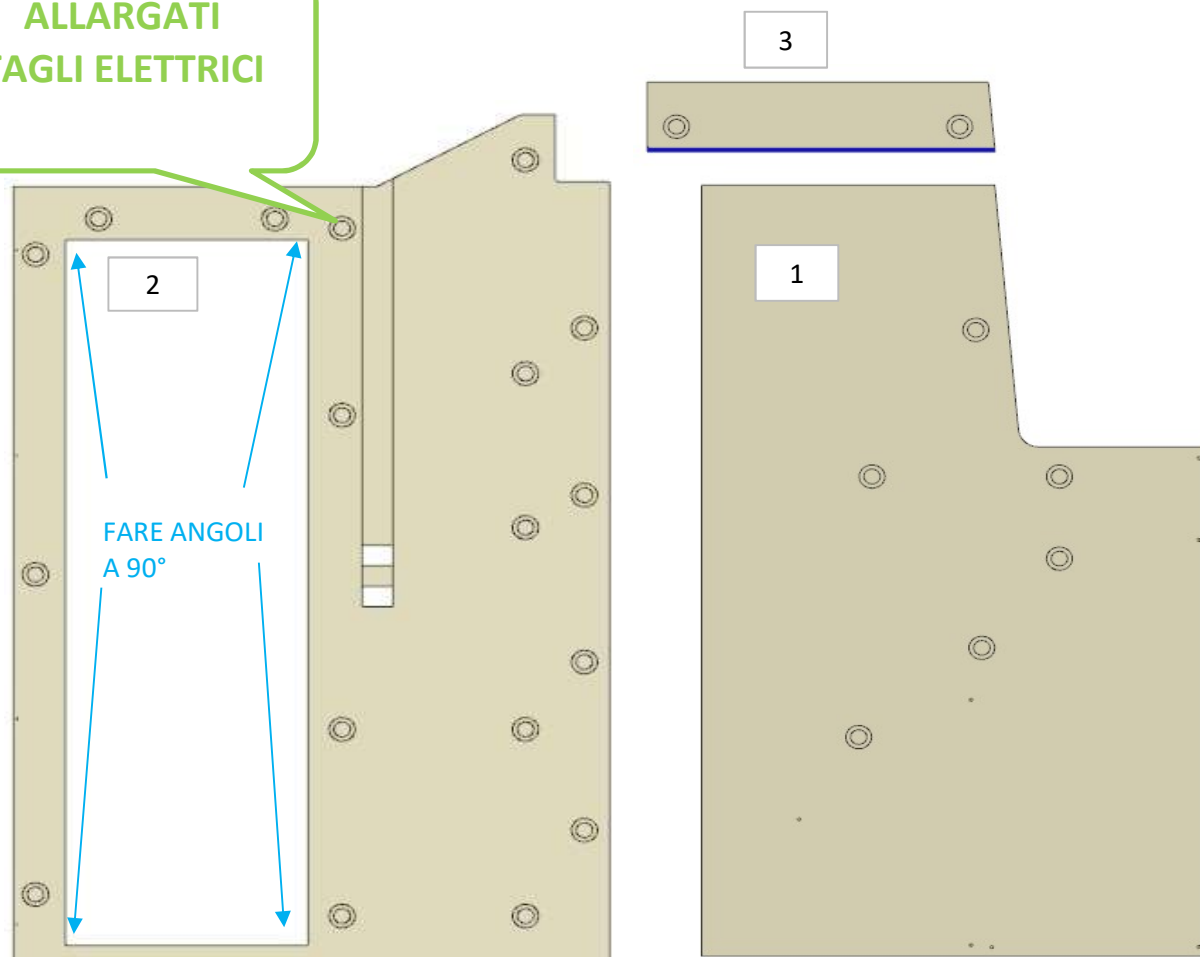

- 1 - L.1240 x H 2088 x sp 19
- 2 - L.1437 x H 2267 x sp 19
- 3 - L. 846 x H 179 x sp 19

ELEMENTO DA
MONTARE con:
PR10
e spedire con un unico
imballo

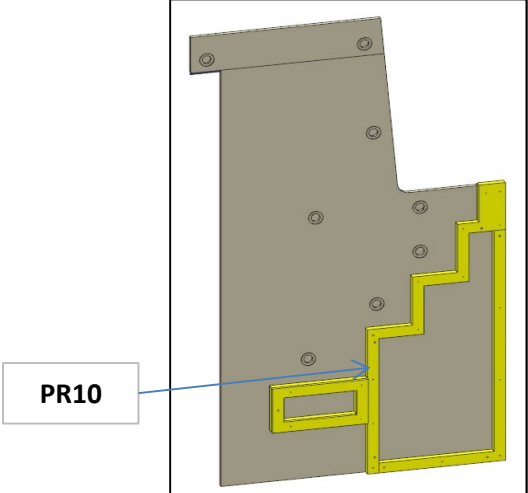

AZ68F

DA MAT. 201

REV. 2022

| LOCALE | CODICE | DESCRIZIONE COMPONENTE | FINITURA | Q.TA | OPERATORE |
|---------|----------------|----------------------------|----------------|------|-----------|
| PARATIE | AZ68F-I01_PR10 | PARETE CABINA OSPITI DX CN | OKOUME' GREZZO | 4 | Dante |

- 1 - L 1228 x H.2299 x sp 15
- 2 - L 602 x H.2240 x sp 15
- 3 - L 585 x H.109 x sp 15
- 4 - L 160 x H.2001 x sp 15

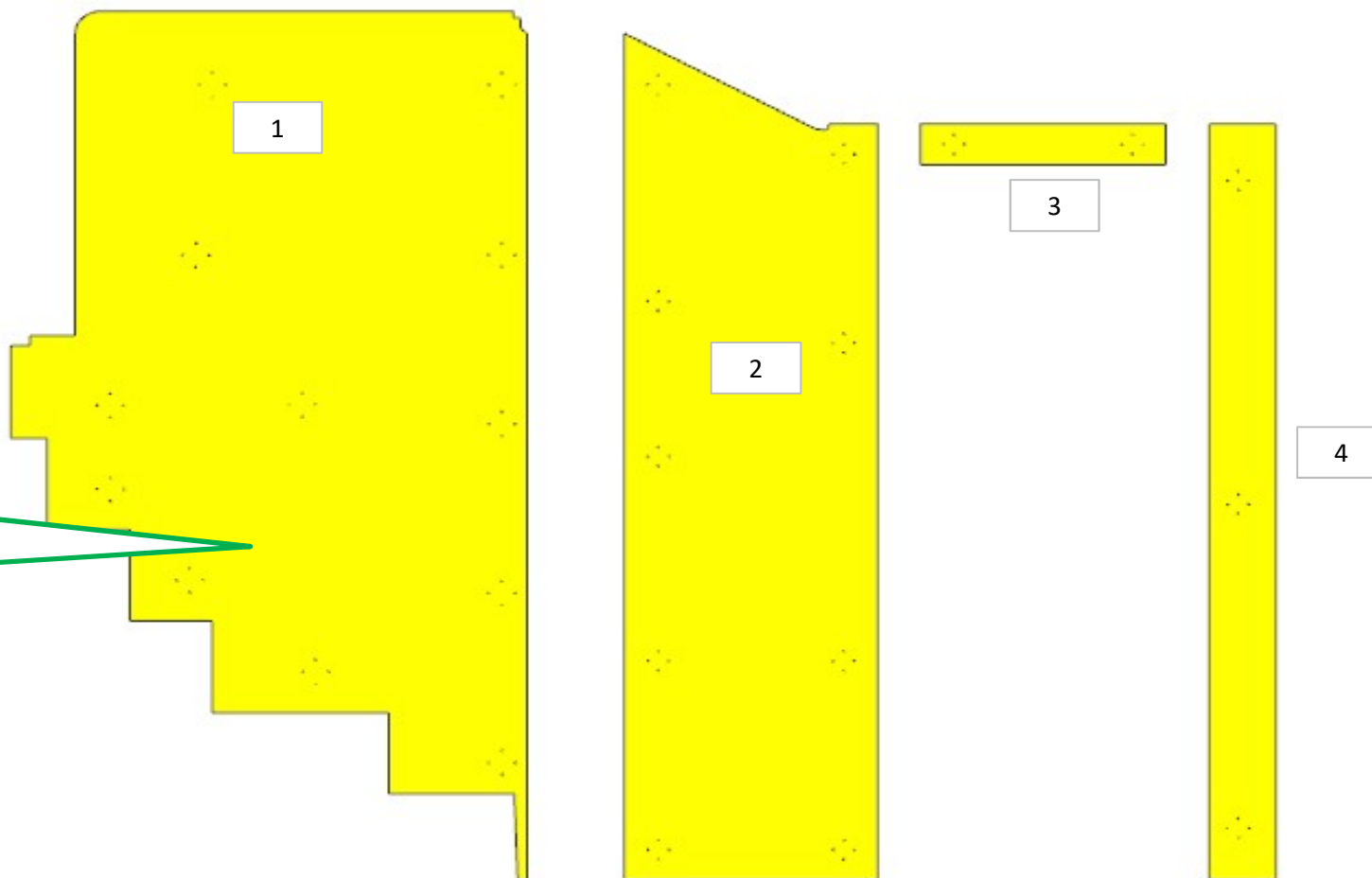

MODIFICATO
VERIFICARE
MISURE

AZ68F

DA MAT 233

REV. 29-04-2024

| LOCALE | CODICE | DESCRIZIONE COMPONENTE | FINITURA | Q.TA | OPERATORE |
|---------|----------------|----------------------------|---------------|------|-----------|
| PARATIE | AZ68F-R01_PR11 | PARETE CABINA OSPITI SX CN | LASTRA CHIARA | 1 | Damiano |

1 - L.1458 x H 2267 x sp 19

111-112
AGGIUNTI
TAGLI ELETTRICI

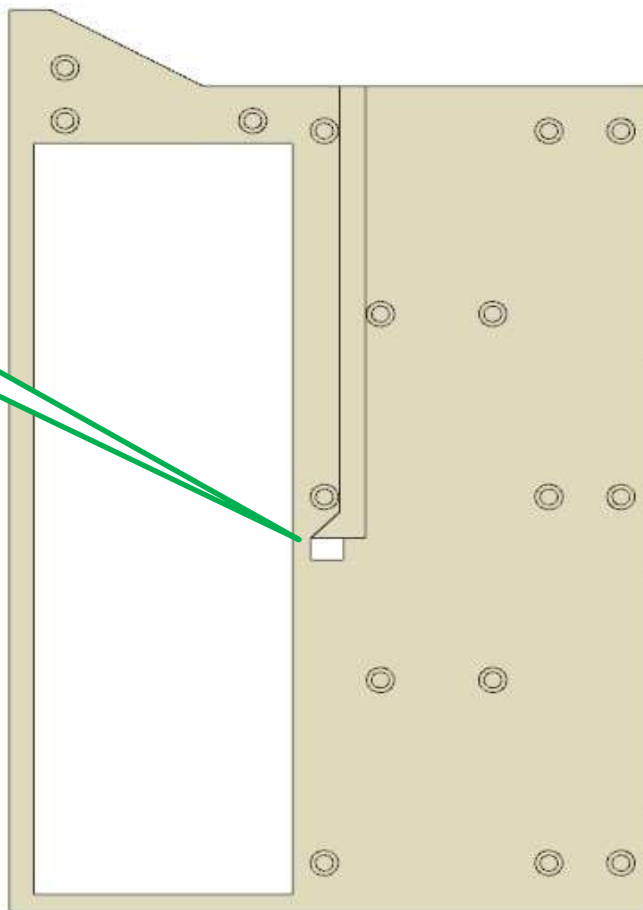

FERRAMENTA:
N° 13 - FITLOCK MASCHIO
N° 16 - FITLOCK FEMMINA
N° 4 - BUSSOLA ZAMA 6MA

AZ68F

REV. 2022

| LOCALE | CODICE | DESCRIZIONE COMPONENTE | FINITURA | Q.TA | OPERATORE |
|---------|----------------|----------------------------|----------------|------|-----------|
| PARATIE | AZ68F-I01_PR11 | PARETE CABINA OSPITI SX CN | OKOUME' GREZZO | 2 | Dante |

1 - L 585 x H 318 x sp 15
2 - L 658 x H 2001 x sp 15

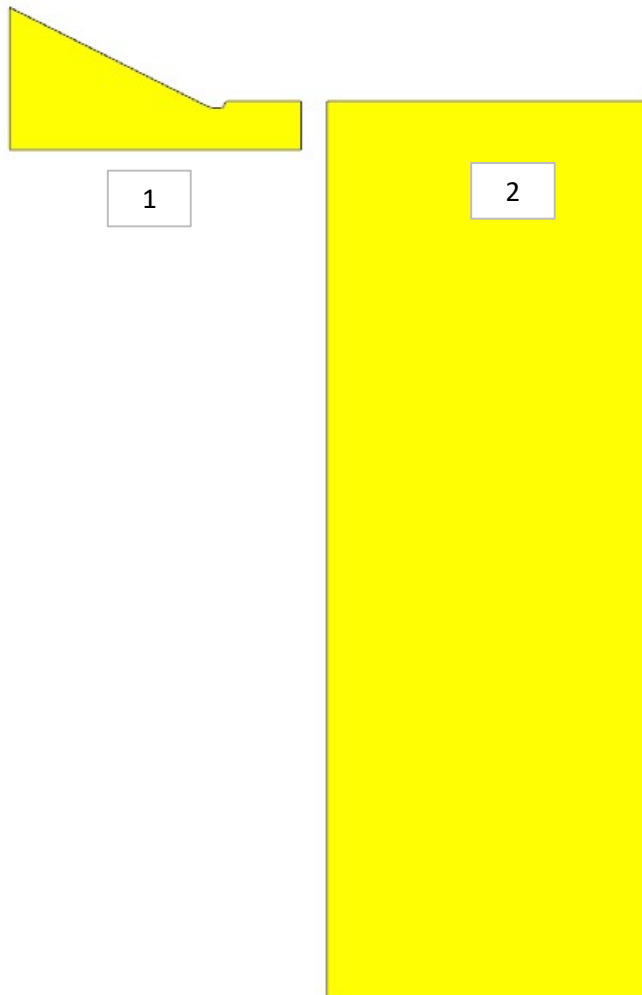

AZ68F

DA MAT 233

Gennaio 2023

| LOCALE | CODICE | DESCRIZIONE COMPONENTE | FINITURA | Q.TA | OPERATORE |
|---------|------------|-------------------------------|----------------|------|-----------|
| PARATIE | AZ68F-PR12 | PARETE CABINA OSPITI SX POPPA | OKOUME' GREZZO | 1 | Damiano |

1 - L.1292 x H.2198 x sp 19

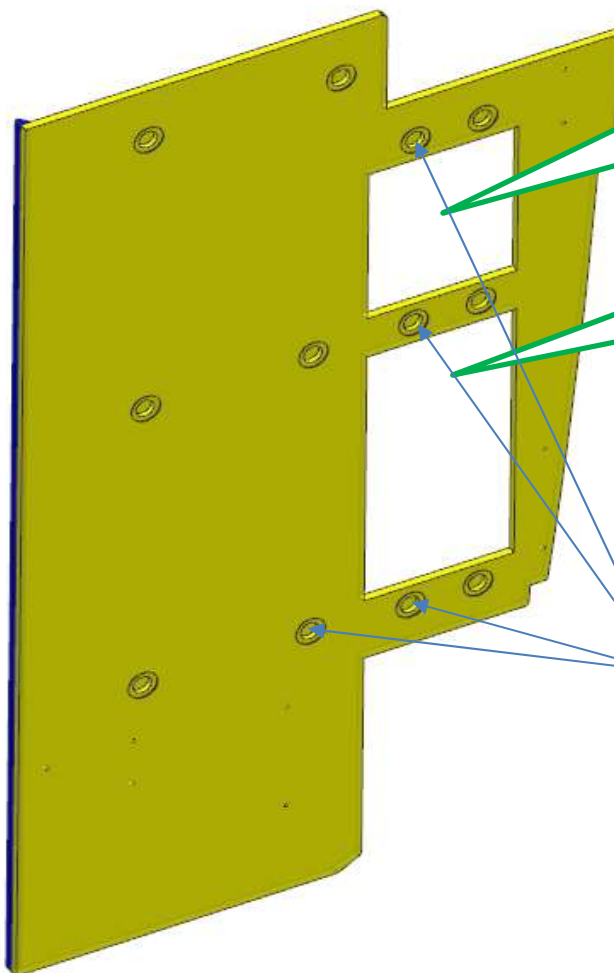

136
AGGIUNTA FINESTRA PASSANTE

136
AGGIUNTA FINESTRA PASSANTE

135
AGGIUNTI ABBASSAMENTI FITLOCK

FERRAMENTA:

N° 12 - FITLOCK FEMMINA
N° 9 - BUSSOLA ZAMA 6MA