

AZ68F

DA MAT 265

REV. 29-04-2024

LOCALE	CODICE	DESCRIZIONE COMPONENTE	FINITURA	Q.TA	OPERATORE
CABINA ARMATORE	AZ68F-I01_AB01	STRUTTURA TV A MURATA SX	OKOUME' GREZZO	1	Dante

1 - L.2070 x H.698 x sp 19

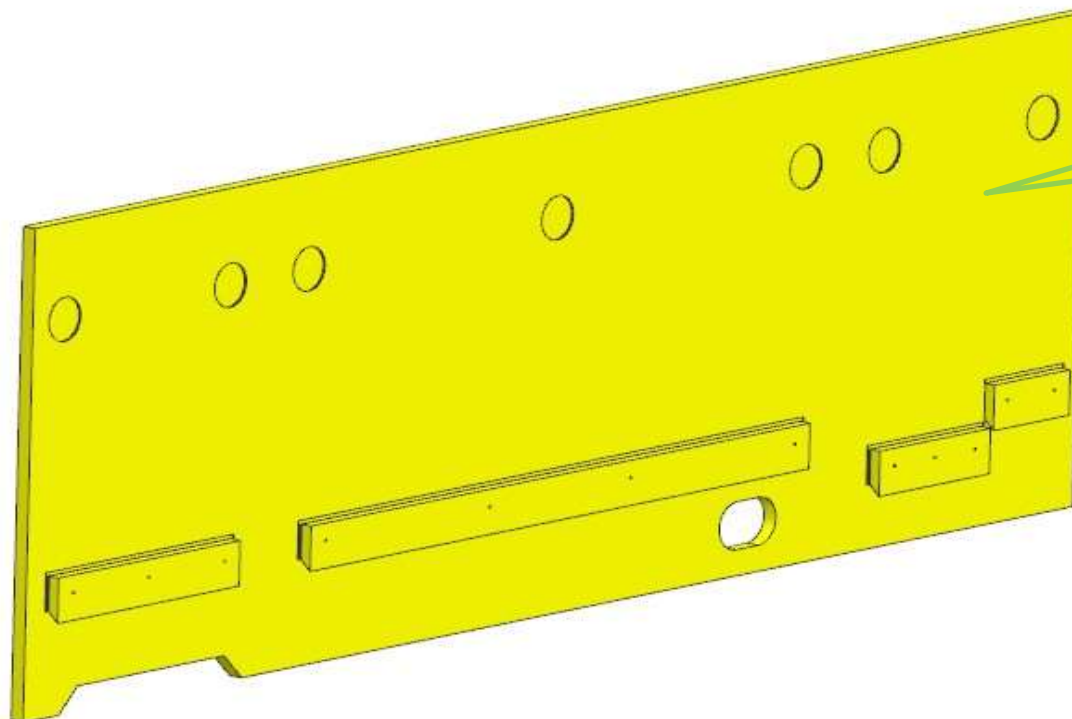

ELIMINATI RIBASSI

AZ68F

DA MAT 237

REV. 29-04-2024

LOCALE	CODICE	DESCRIZIONE COMPONENTE	FINITURA	Q.TA	OPERATORE
CABINA ARMATORE	AZ68F-I01_AF01	RIVESTIMENTO POPPA SX	OKOUME' GREZZO	1	Dante

1 - L 506 (SVILUPPO) x H744 x sp 19

ELIMINATO RIBASSO

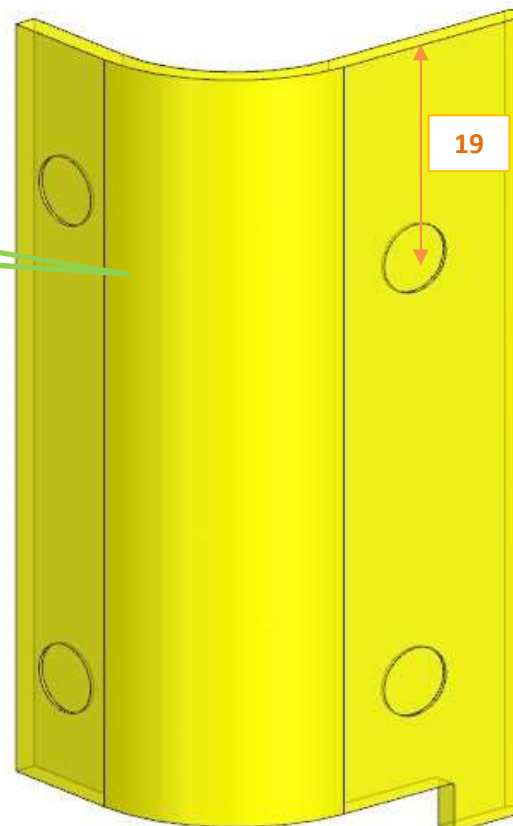

AZ68F

DA MAT 237

REV. 29-04-2024

LOCALE	CODICE	DESCRIZIONE COMPONENTE	FINITURA	Q.TA	OPERATORE
CABINA ARMATORE	AZ68F-I01_AG01	RIVESTIMENTO PRUA SX	OKOUME' GREZZO	1	Dante

1 - L 506 (SVILUPPO) x H744 x sp 19

ELIMINATO RIBASSO

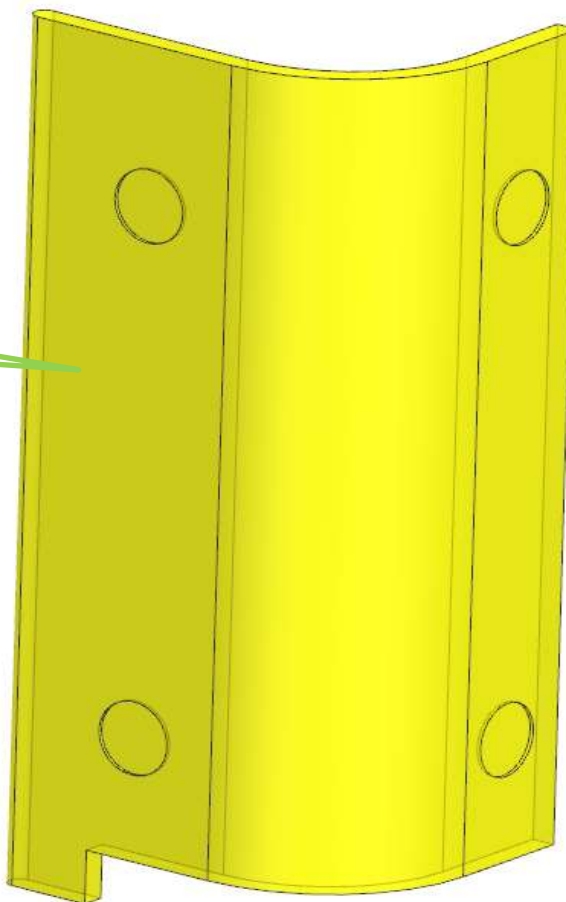

AZ68F

DA MAT. 237

REV. 29-04-2024

LOCALE	CODICE	DESCRIZIONE COMPONENTE	FINITURA	Q.TA	OPERATORE
CABINA ARMATORE	AZ68F-I01_AM01	STRUTTURA DX ANGOLO POPPA	OKOUME' GREZZO	1	Dante

1 - SVILUPPO 1071 x H 707 x sp 19

142
SPEDIRE
PEZZO UNICO

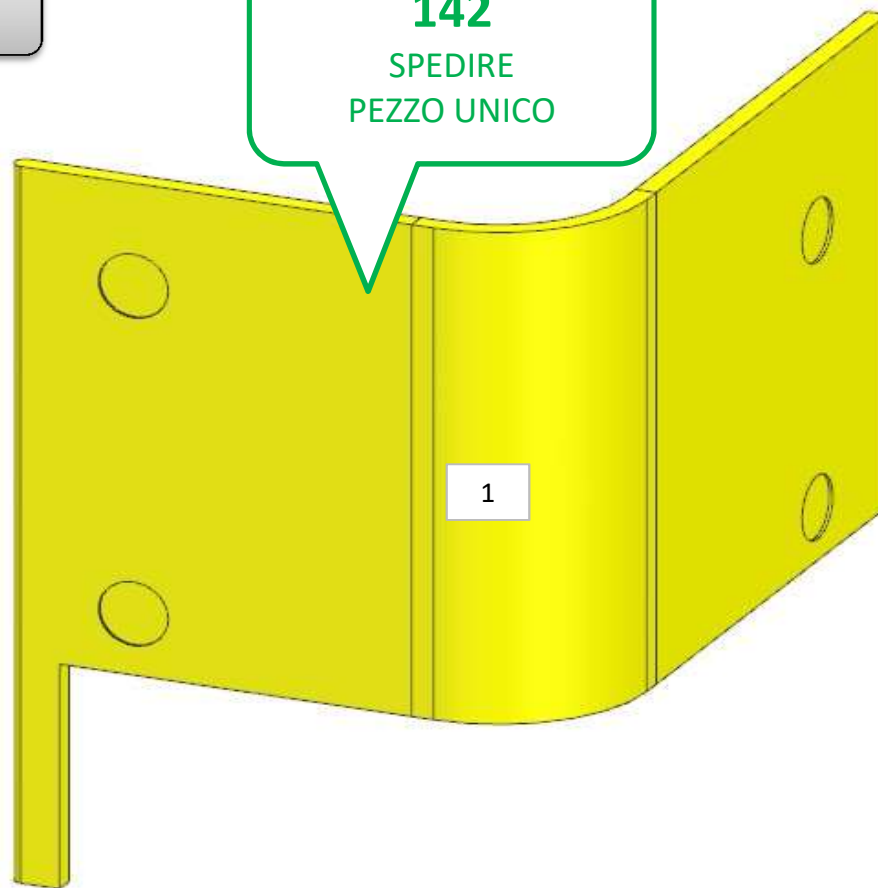

AZ68F

DA MAT. 237

REV. 29-04-2024

LOCALE	CODICE	DESCRIZIONE COMPONENTE	FINITURA	Q.TA	OPERATORE
CABINA ARMATORE	AZ68F-I01_AO01	STRUTTURA BASSA A MURATA DX	OKOUME' GREZZO	1	Dante

1 - L 2140 x H485 x sp 19

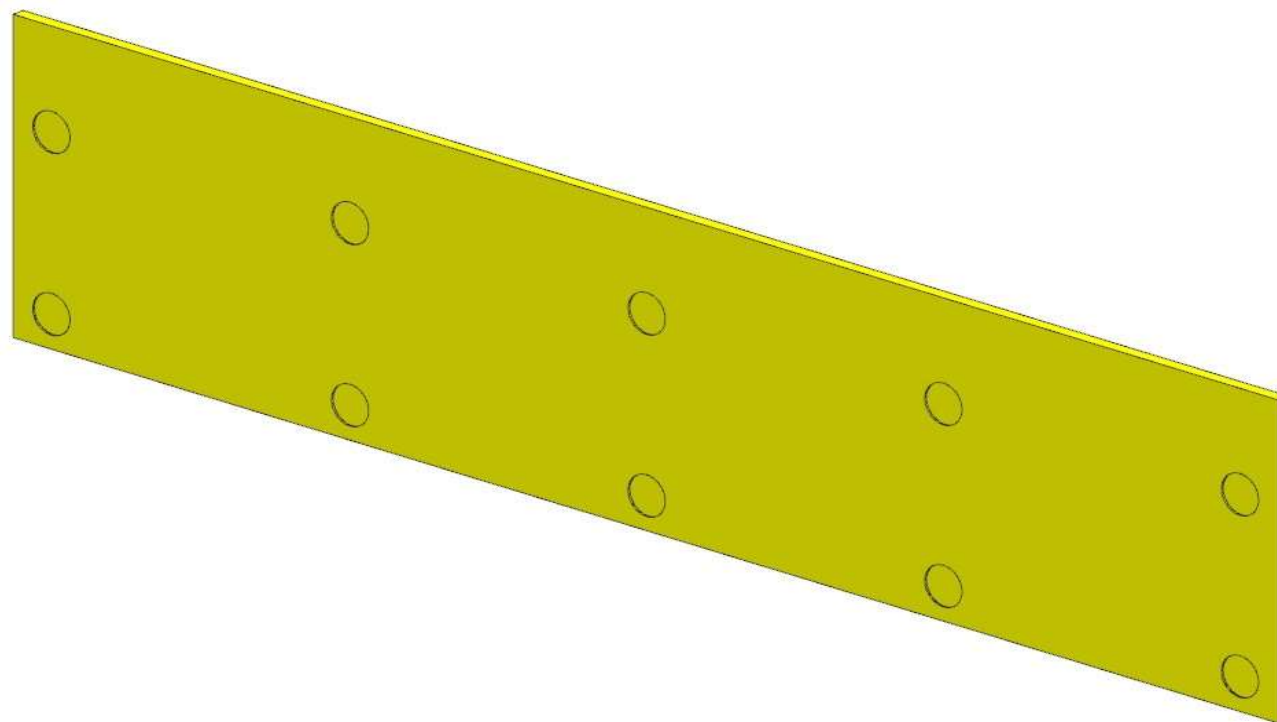

AZ68F

DA MAT. 237 REV. 29-04-2024

LOCALE	CODICE	DESCRIZIONE COMPONENTE	FINITURA	Q.TA	OPERATORE
CABINA ARMATORE	AZ68F-I01_AP01	STRUTTURA DX ANGOLO PRUA	OKOUME' GREZZO	2	Dante/Damiano

1 - SVILUPPO 912 x H.707 x sp 19
2 - L 1110 x H 1952 x sp 16

142
SPEDIRE
PEZZO UNICO

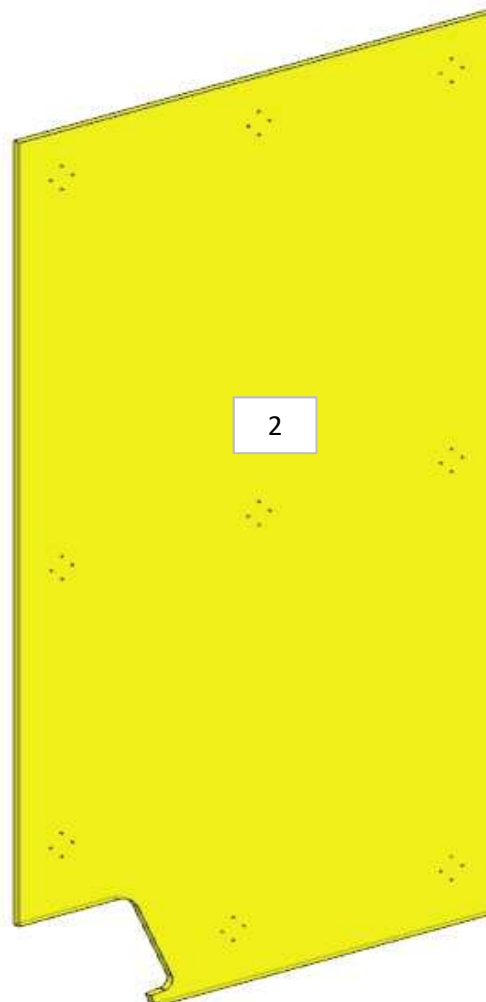
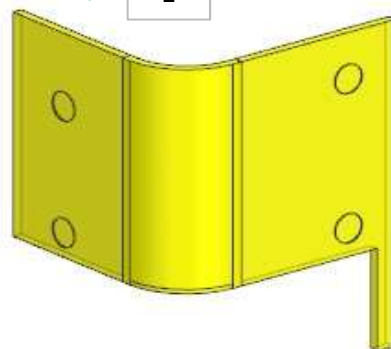

AZ68F

DA MAT. 233

REV. 29-04-2024

LOCALE	CODICE	DESCRIZIONE COMPONENTE	FINITURA	Q.TA	OPERATORE
CABINA ARMATORE	AZ68F-I01__AQ01	LETTO	OKOUME' GREZZO	3	Dante

1 - 3 - L.1428 x H.185 x sp 15mm
2 - SVILUPPO L.1694 x H.185 x sp 13mm

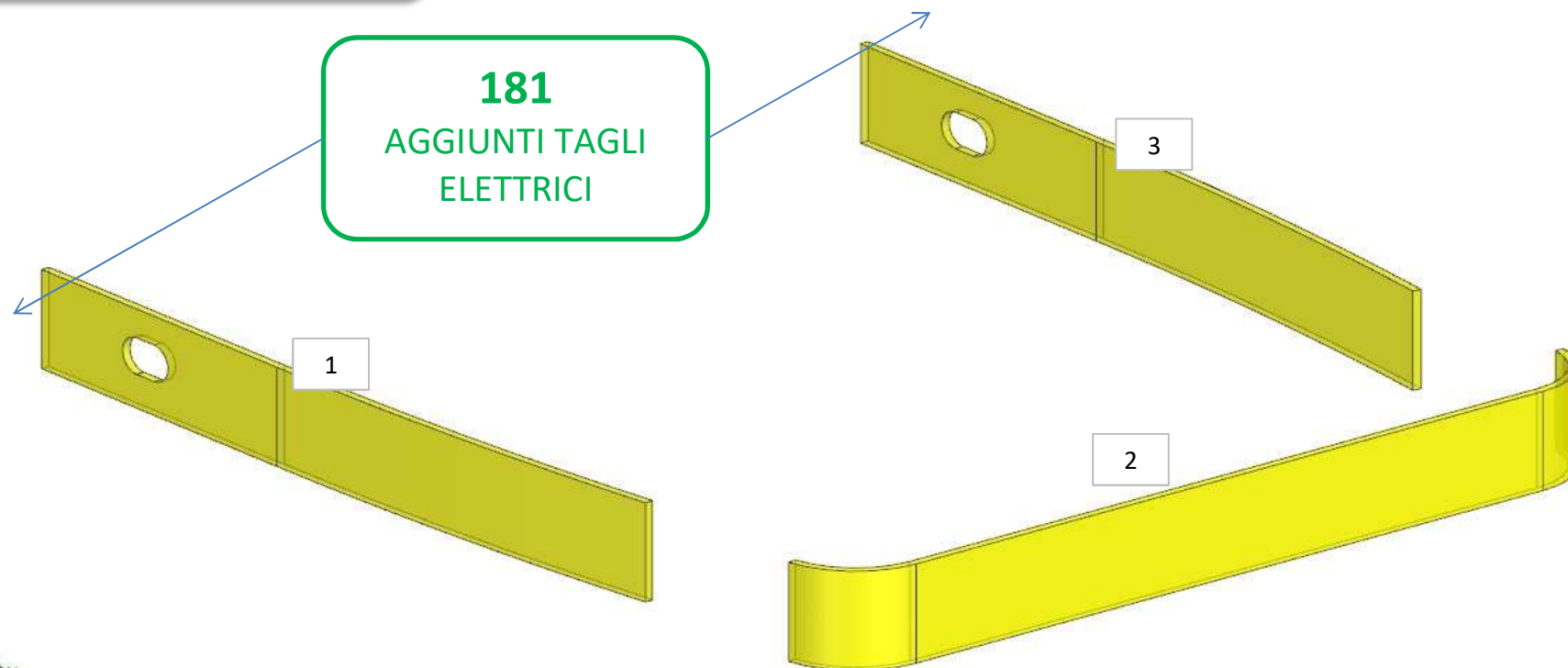

AZ68F

DA MAT. 203

REV. 29-04-2024

LOCALE	CODICE	DESCRIZIONE COMPONENTE	FINITURA	Q.TA	OPERATORE
CABINA ARMATORE	AZ68F-I01_AR01	COMODINO POPPA	OKOUME' GREZZO	1	Dante

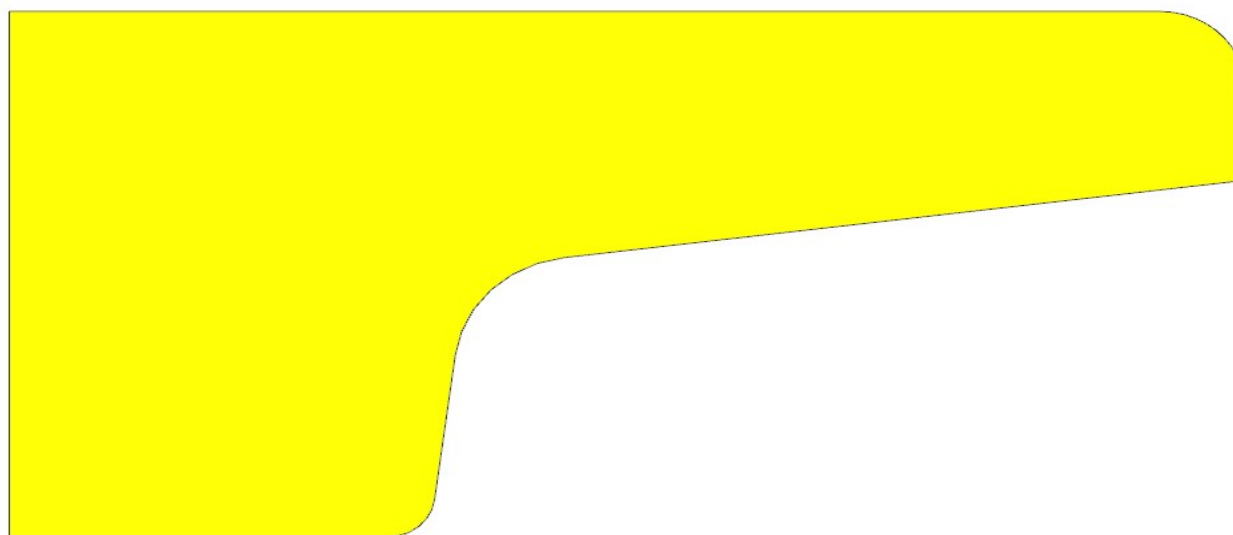

1 - L.1001 x H.472 x sp 10

AZ68F

DA MAT. 203

REV. 29-04-2024

LOCALE	CODICE	DESCRIZIONE COMPONENTE	FINITURA	Q.TA	OPERATORE
CABINA ARMATORE	AZ68F-I01_AS01	COMODINO PRUA	OKOUME' GREZZO	1	Dante

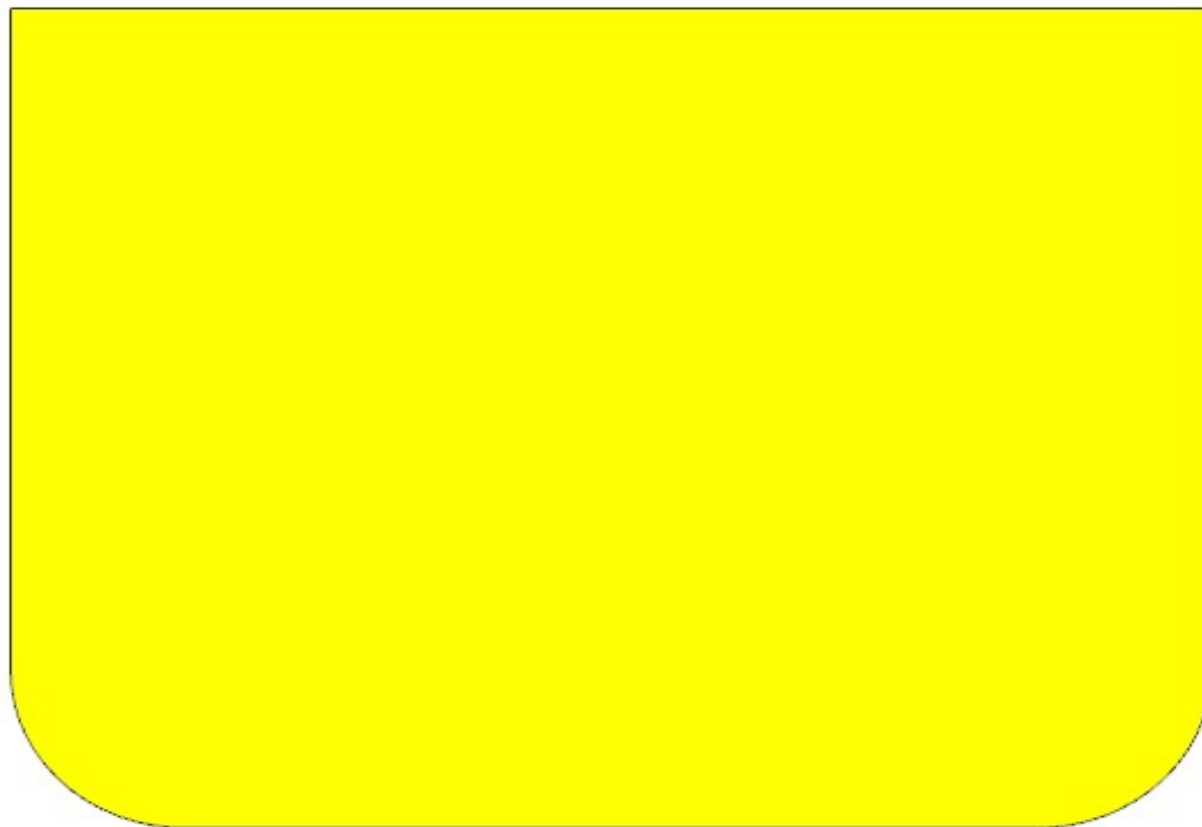

1 - L.472 x H 357 x sp 10

AZ68F

DA MAT. 233

REV. 29-04-2024

LOCALE	CODICE	DESCRIZIONE COMPONENTE	FINITURA	Q.TA	OPERATORE
CABINA ARMATORE	AZ68F-I01_AAM01	STRUTTURA DX ANGOLO POPPA OPT	OKOUME' GREZZO	3	Dante

- 1 - L 401 x H 1954,5 x sp 15
- 2 - L 362 x H 708 x sp 19
- 3 - L 332 x H 485,5 x sp 19

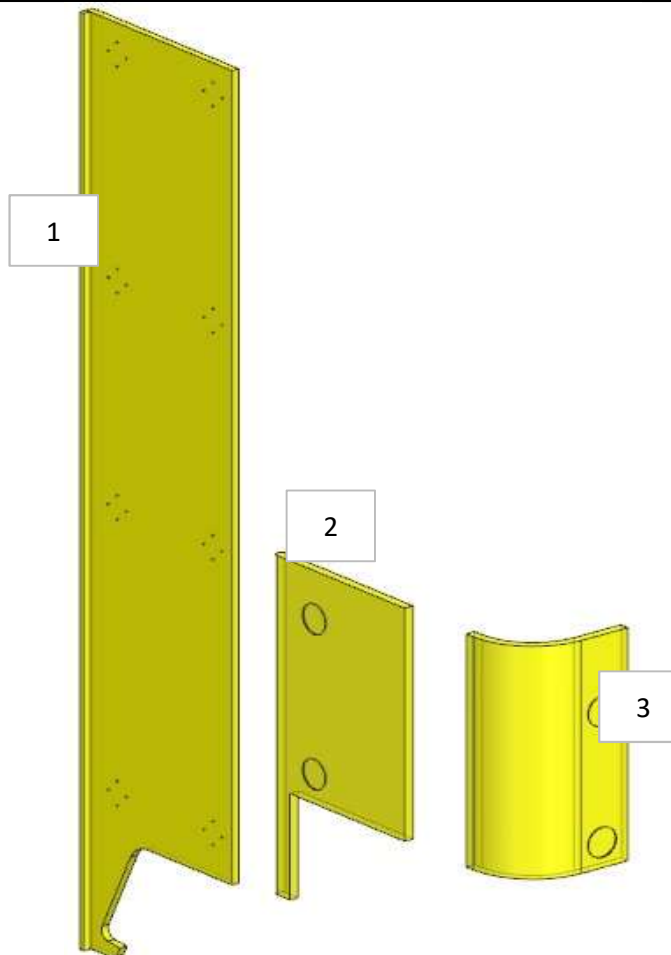

AZ68F

DA MAT. 233

REV. 29-04-2024

LOCALE	CODICE	DESCRIZIONE COMPONENTE	FINITURA	Q.TA	OPERATORE
CABINA ARMATORE	AZ68F-I01_AAO01	STRUTTURA BASSA A MURATA DX OPT	OKOUME' GREZZO	1	Dante

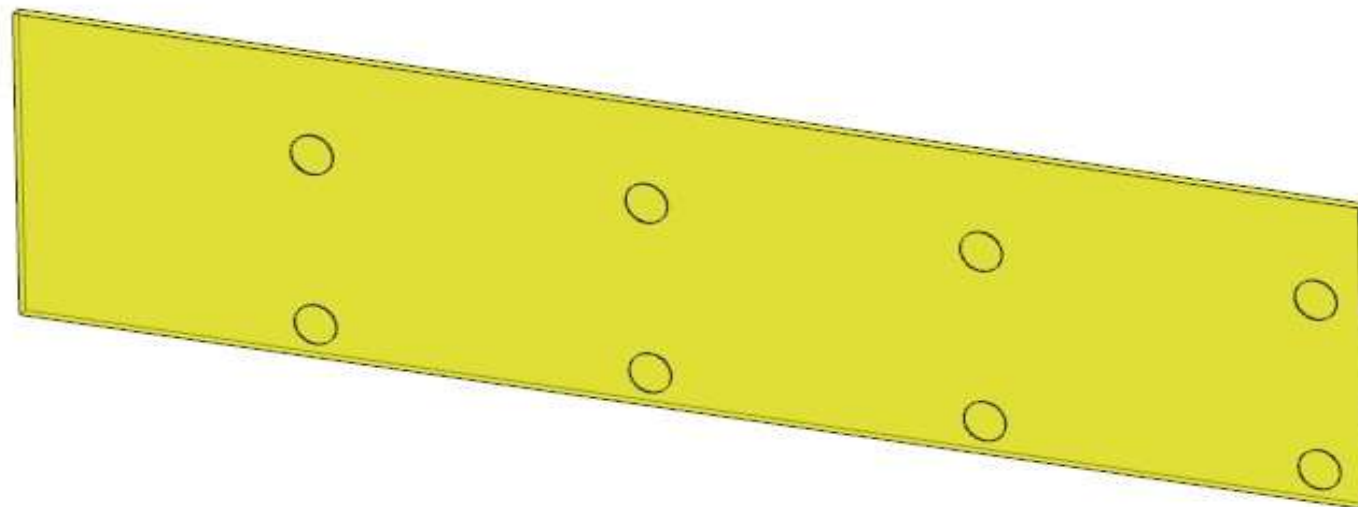

AZ68F

DA MAT. 203

REV. 29-04-2024

LOCALE	CODICE	DESCRIZIONE COMPONENTE	FINITURA	Q.TA	OPERATORE
CABINA ARMATORE	AZ68F-I01_AAR01	COMODINO POPPA OPT	OKOUME' GREZZO	1	Dante

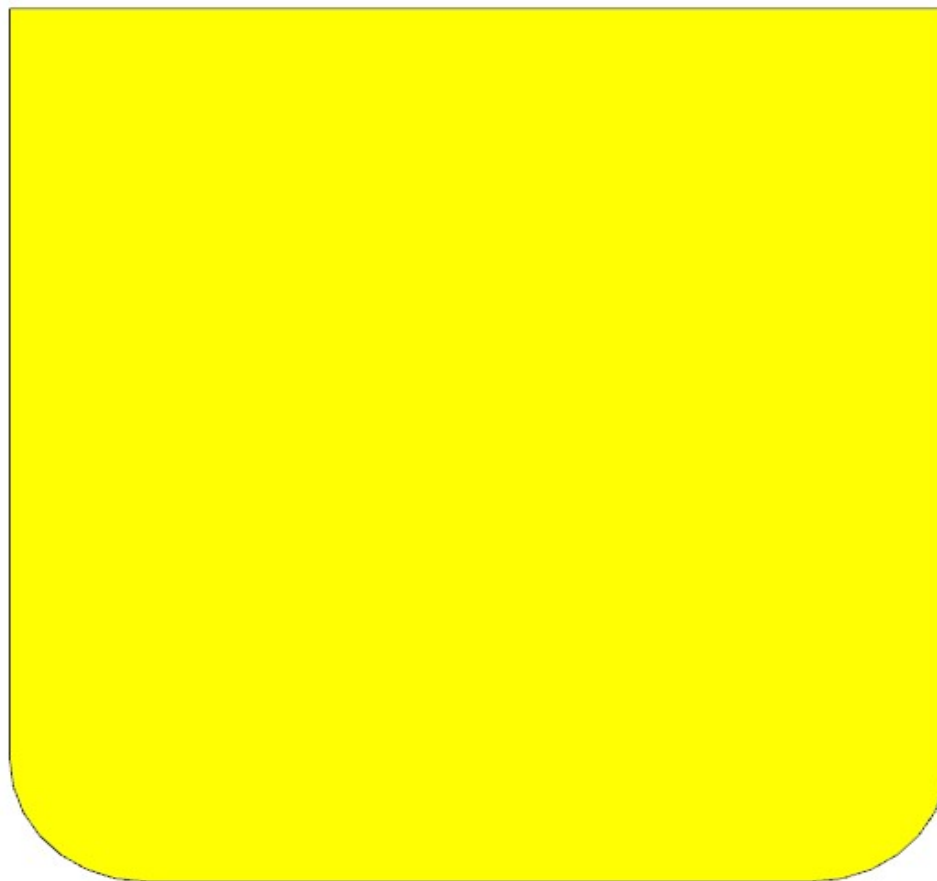

1 - L 488 x H 472 x sp 10

AZ68F

DA MAT. 237

REV. 2022

LOCALE	CODICE	DESCRIZIONE COMPONENTE	FINITURA	Q.TA	OPERATORE
CABINA VIP	AZ68F-I01_VA01	LETTO	OKOUME' GREZZO	3	Dante

1 - 3 - L 848 x H 178 x sp 15
2 - sviluppo 1693 x H 178 x sp 15

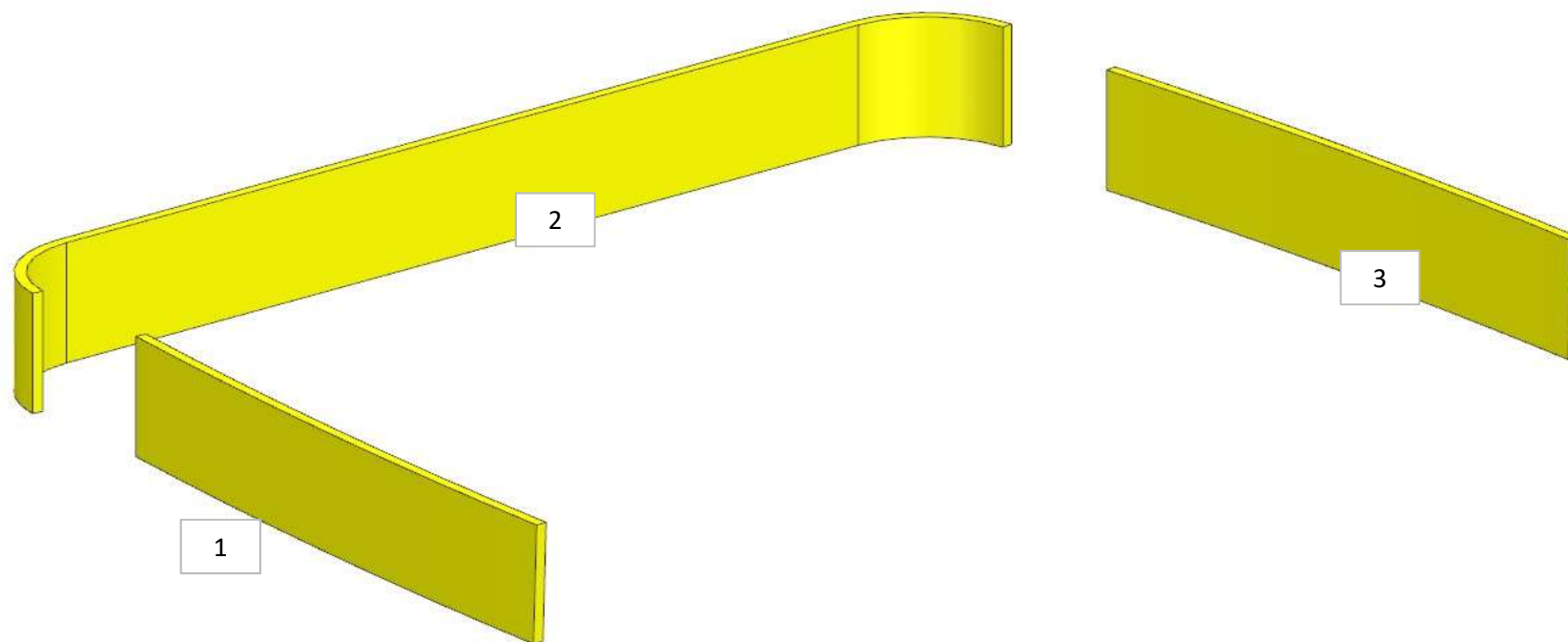

AZ68F

DA MAT. 237

REV. 2022

LOCALE	CODICE	DESCRIZIONE COMPONENTE	FINITURA	Q.TA	OPERATORE
CABINA VIP	AZ68F-I01_VB01	TESTA LETTO	OKOUME' GREZZO	1	Dante

1 - L.1936 x H.461 x sp 19

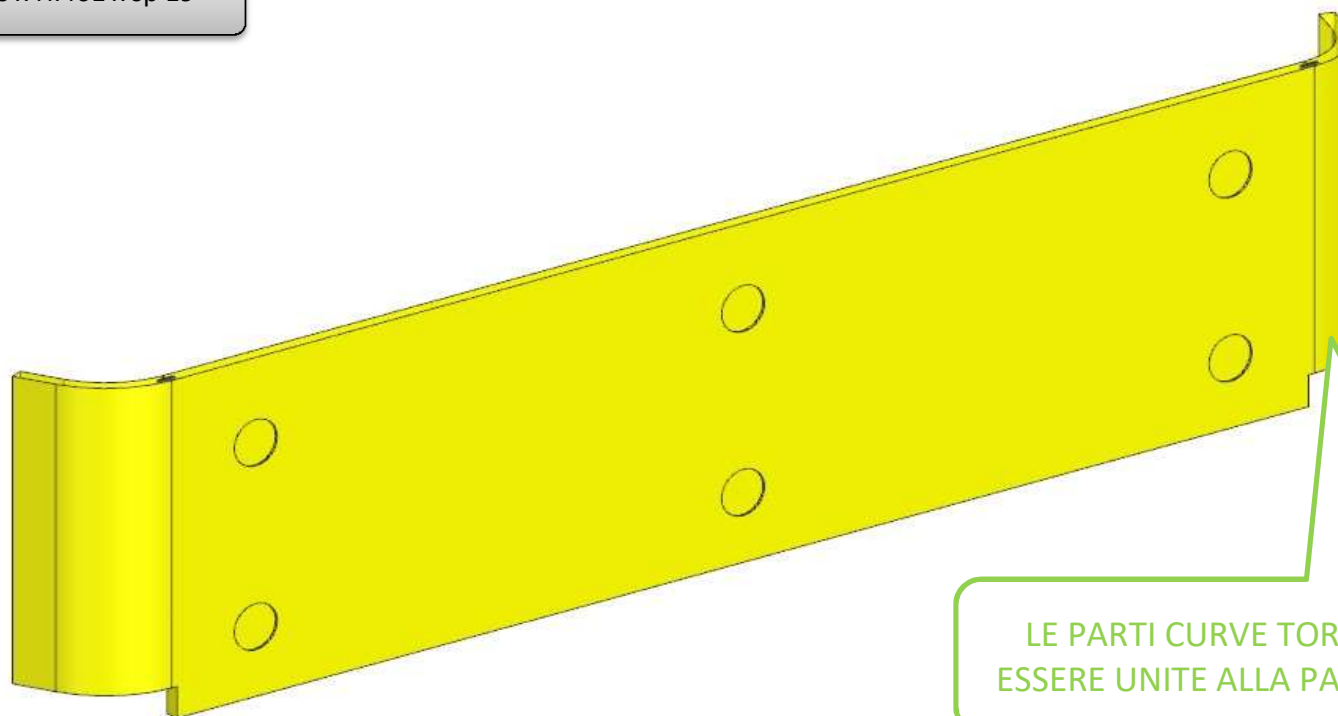

LE PARTI CURVE TORNANO AD
ESSERE UNITE ALLA PARTE DRITTA

AZ68F

DA MAT. 237

REV. 2022

LOCALE	CODICE	DESCRIZIONE COMPONENTE	FINITURA	Q.TA	OPERATORE
CABINA VIP	AZ68F-I01_VC01	MURATA SX A.C.	OKOUME' GREZZO	2	Dante

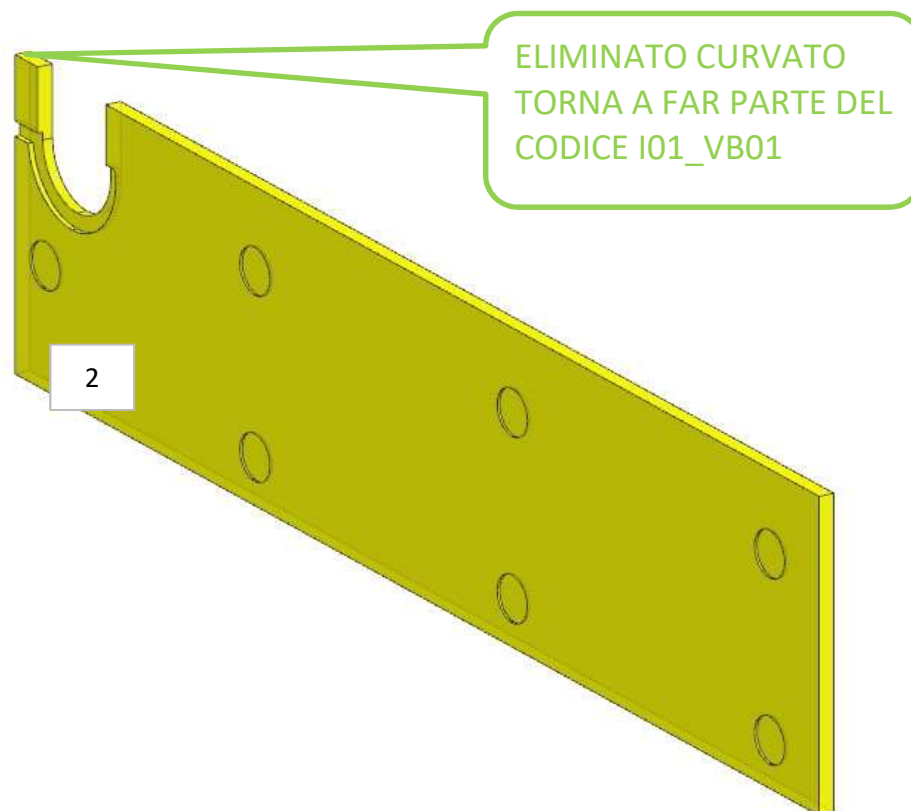

1 - L.183 x H.559 x sp 19mm
2 - 1677 x H.418 x sp 19mm

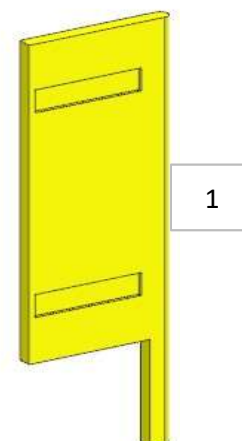

AZ68F

DA MAT. 237

REV. 2022

LOCALE	CODICE	DESCRIZIONE COMPONENTE	FINITURA	Q.TA	OPERATORE
CABINA VIP	AZ68F-I01_VG01	MURATA DX TRATTAMENTO ARIA	OKOUME' GREZZO	2	Dante

1 - 1677x H 418 x sp 19mm
2 - L 183 x H 559 x sp 19mm

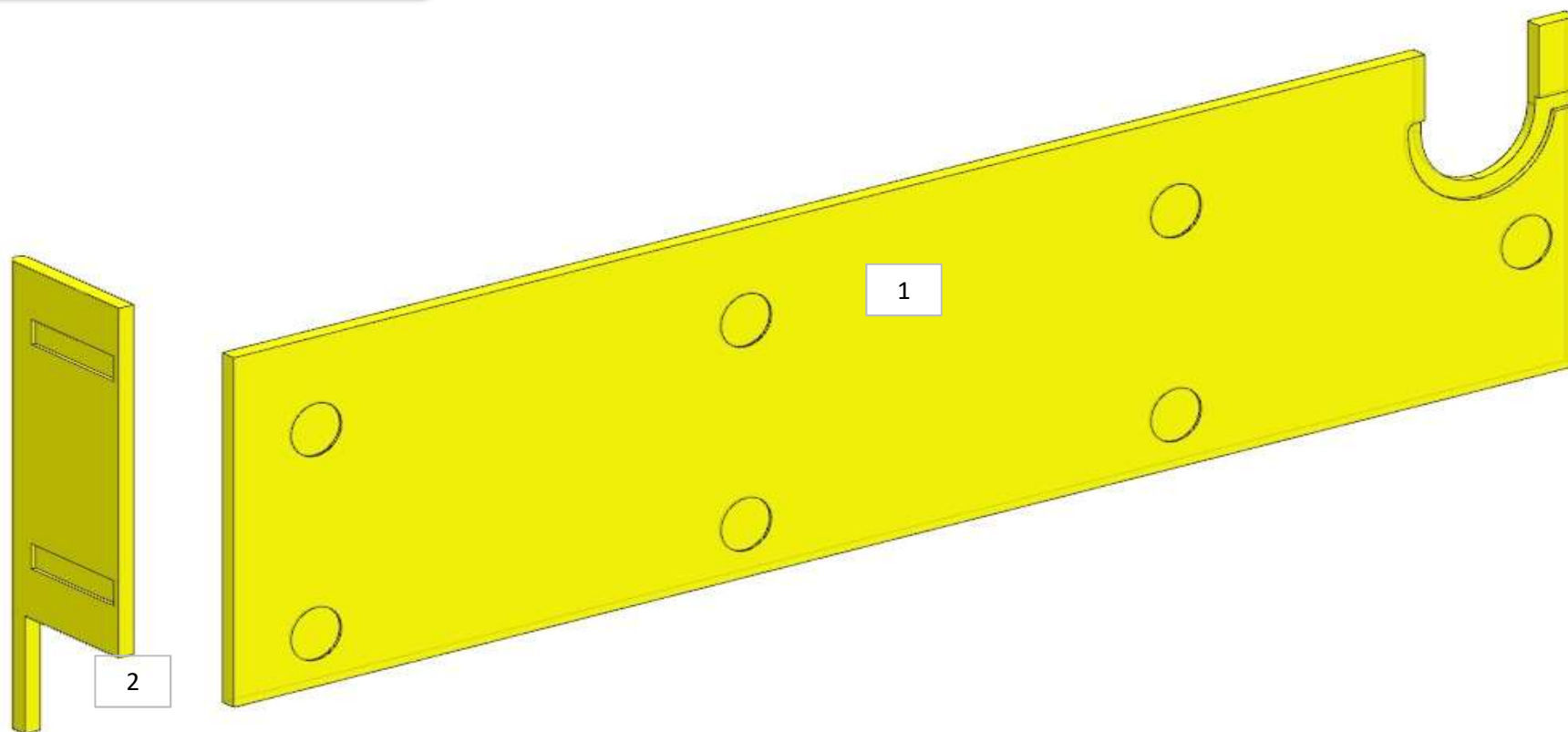

AZ68F

DA MAT. 237

REV. 2022

LOCALE	CODICE	DESCRIZIONE COMPONENTE	FINITURA	Q.TA	OPERATORE
CABINA VIP	AZ68F-I01_VP01	CIELINO	OKOUME' GREZZO	8	Dante

7 - L 430 x H 433 x sp 10mm
8 - L 667 x H 700 x sp 10mm

ELIMINATE
CORNICI DA
GRUPPO 7

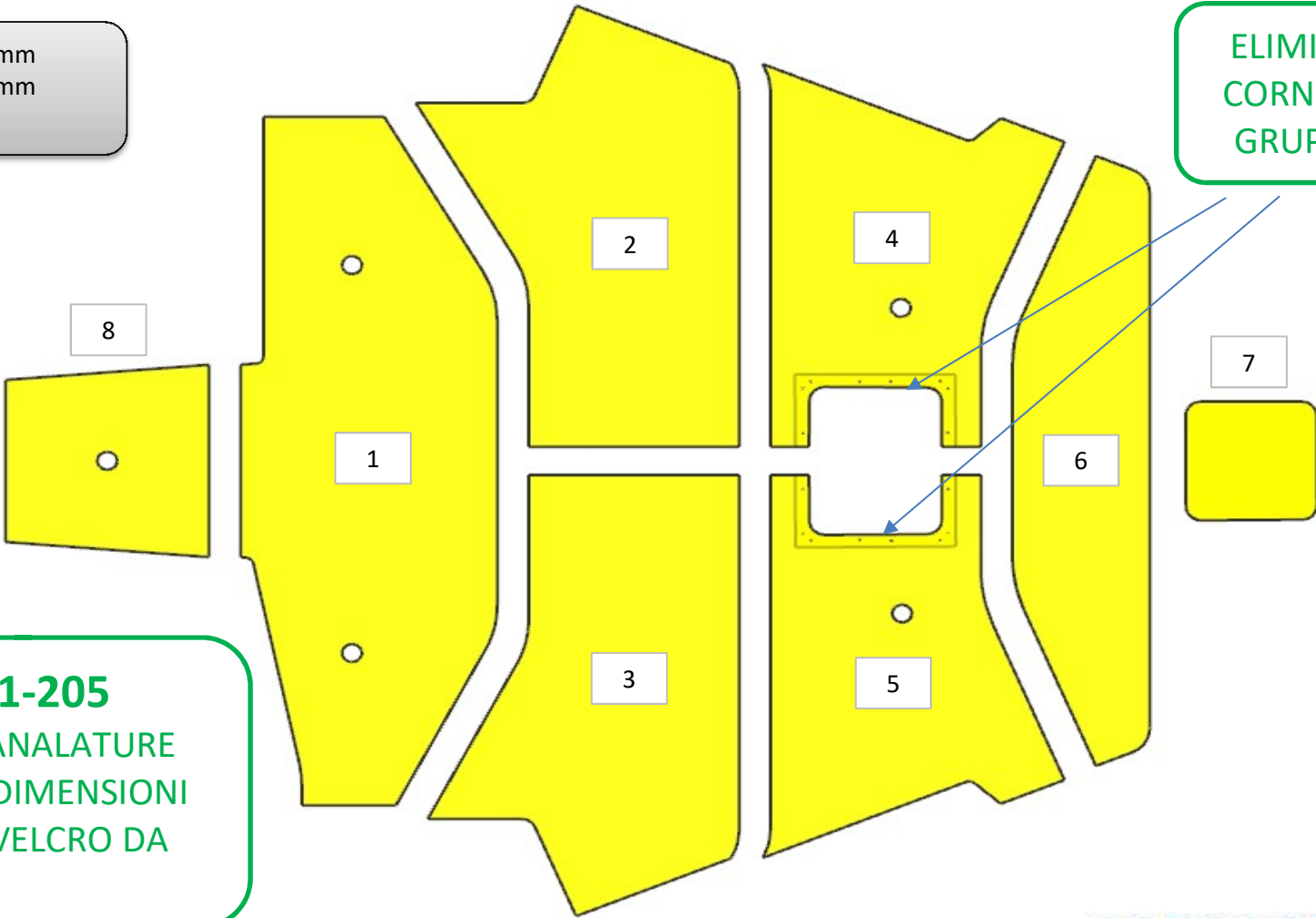

156-161-205
RIMOSSE SCANALATURE
MODIFICATE DIMENSIONI
ELIMINATO VELCRO DA

AZ68F

REV. 10-01-2022

LOCALE	CODICE	DESCRIZIONE COMPONENTE	FINITURA	Q.TA	OPERATORE
CABINA OSPITI SX	AZ68F-I01_LA01	LETTO MURATA	OKOUME' GREZZO	2	Dante

1 - L 1406 x H 255 x sp 15
2 - L 5855 x H 255 x sp 15



1



2

AZ68F

REV. 10-01-2022

LOCALE	CODICE	DESCRIZIONE COMPONENTE	FINITURA	Q.TA	OPERATORE
CABINA OSPITI SX	AZ68F-I01_LB01	STRUTTURA MURATA A.C.	OKOUME' GREZZO	1	Dante

1 - L 1217 x H.137 x sp 10

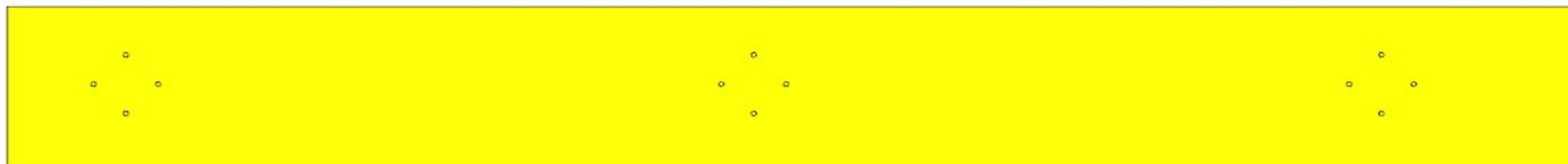

AZ68F

DA MAT. 203 REV. 10-01-2022

LOCALE	CODICE	DESCRIZIONE COMPONENTE	FINITURA	Q.TA	OPERATORE
CABINA OSPITI SX	AZ68F-I01_LD01	LETTO SUPERIORE	OKOUME' GREZZO	2	Dante

- 1 - L.1788
- 2 - L.1786 x H.716 x sp 10

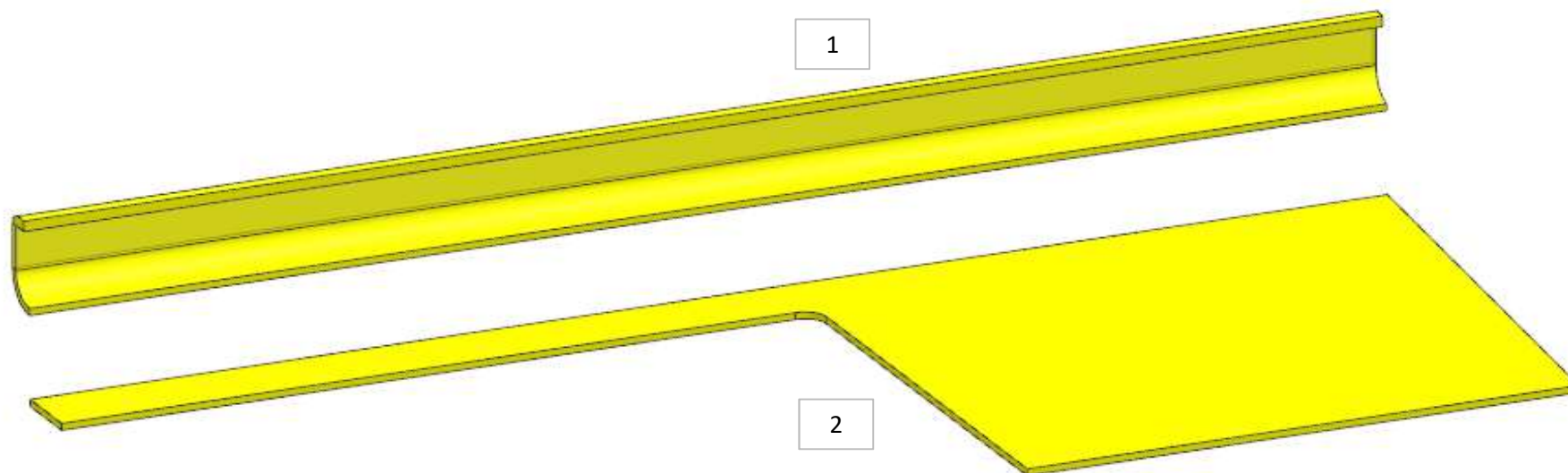

AZ68F

REV. 10-01-2022

LOCALE	CODICE	DESCRIZIONE COMPONENTE	FINITURA	Q.TA	OPERATORE
CABINA OSPITI SX	AZ68F-I01_LI01	CIELINO	OKOUME' GREZZO	4	Dante

- 1 - L.1211 x sp 10
- 2 - L.373 X H. 396 x sp 10
- 3 - L.972 x H. 735 sp 10
- 4 - L.642 x H. 461 sp 10

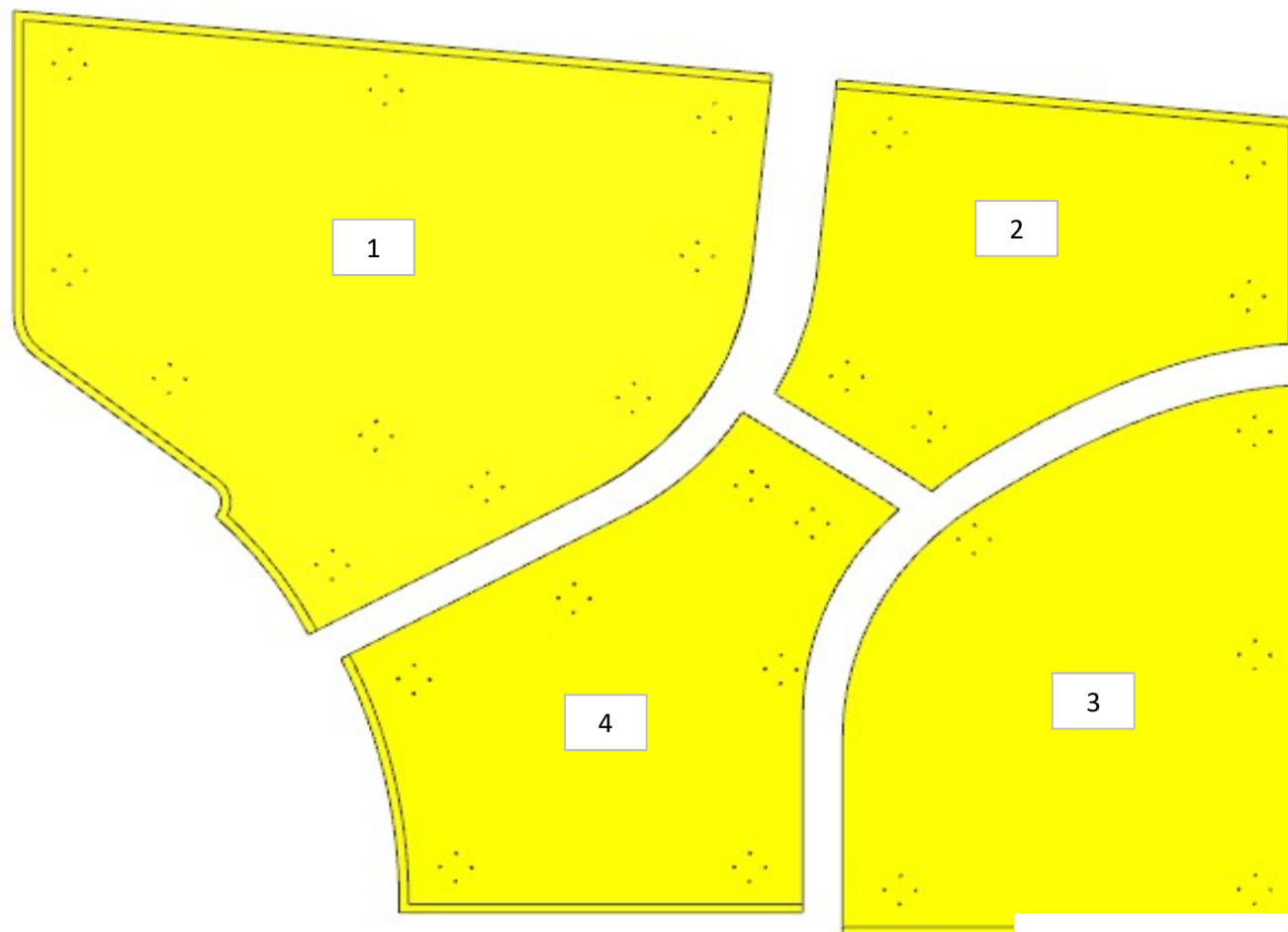

FERRAMENTA:

N° 26 - FITLOCK MASCHIO

AZ68F

REV. 10-01-2022

LOCALE	CODICE	DESCRIZIONE COMPONENTE	FINITURA	Q.TA	OPERATORE
CABINA OSPITI DX	AZ68F-I01_RB01	LETTO MURATA	OKUME' GREZZO	1	Dante

ELIMINATO
RIBASSO

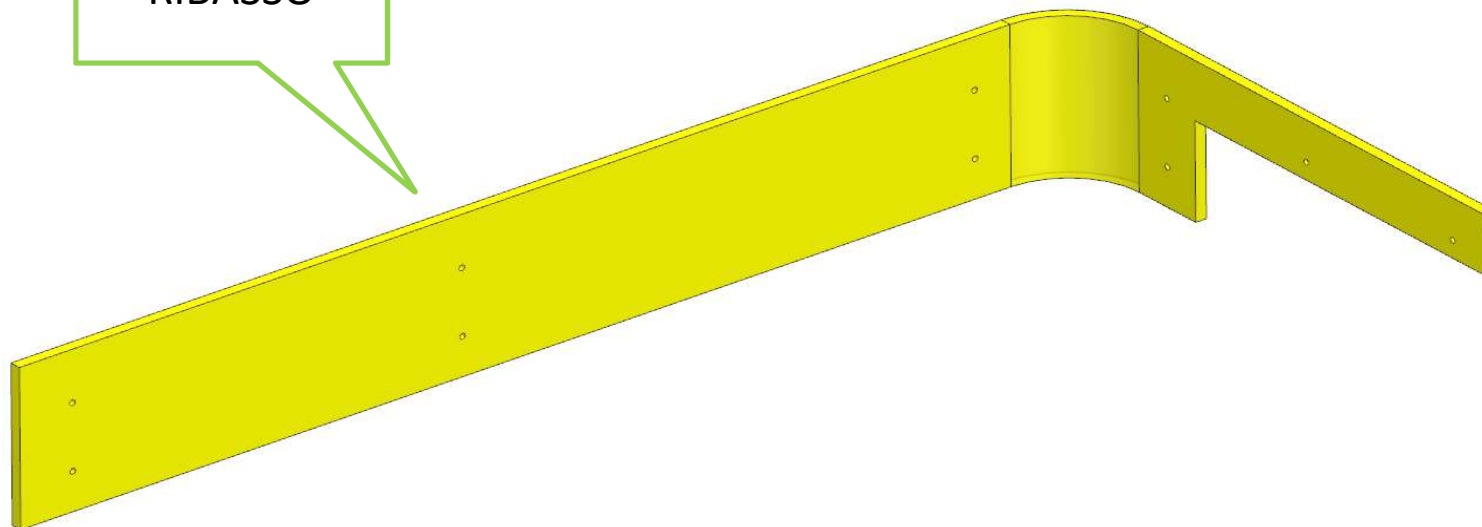

AZ68F

REV. 10-01-2022

LOCALE	CODICE	DESCRIZIONE COMPONENTE	FINITURA	Q.TA	OPERATORE
CABINA OSPITI DX	AZ68F-I01_RC01	STRUTTURA A MURATA	OKOUME' GREZZO	1	Dante

1 - L.1724 x H.465 x sp 19

ELIMINATO
RIBASSO

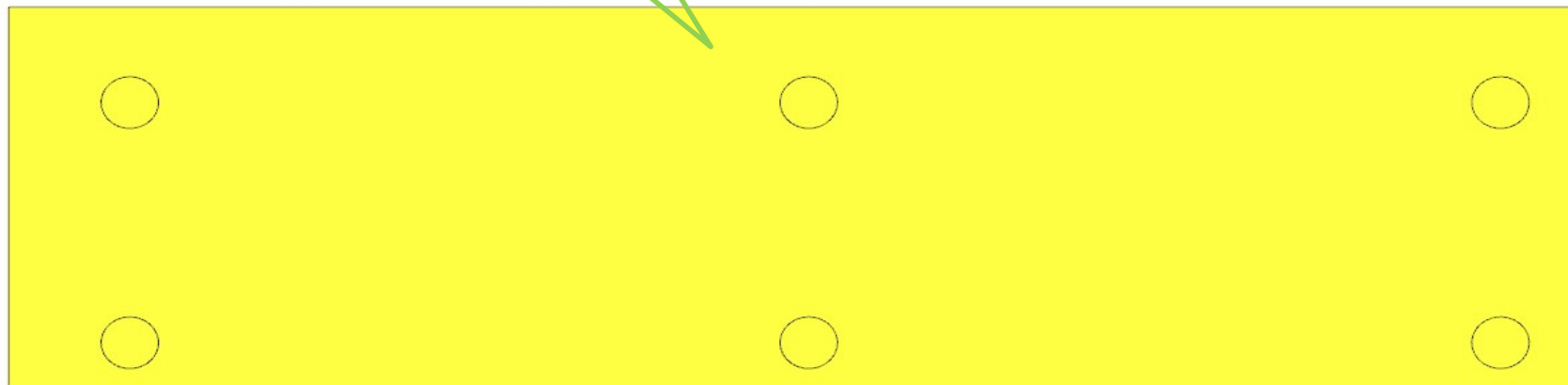

AZ68F

DA MAT. 203 REV. 10-01-2022

LOCALE	CODICE	DESCRIZIONE COMPONENTE	FINITURA	Q.TA	OPERATORE
CABINA OSPITI DX	AZ68F-I01_RD01	PENSILE	OKOUME' GREZZO	2	Dante

1 - L.699 x H.107 x sp 15
2 - L 713 x H.107 x sp 15



1



2

AZ68F

REV. 10-01-2022

LOCALE	CODICE	DESCRIZIONE COMPONENTE	FINITURA	Q.TA	OPERATORE
CABINA OSPITI DX	AZ68F-I01_RE01	TESTALETTO	OKOUME' GREZZO	1	Dante

1 - sviluppo 1970 x H.465 x

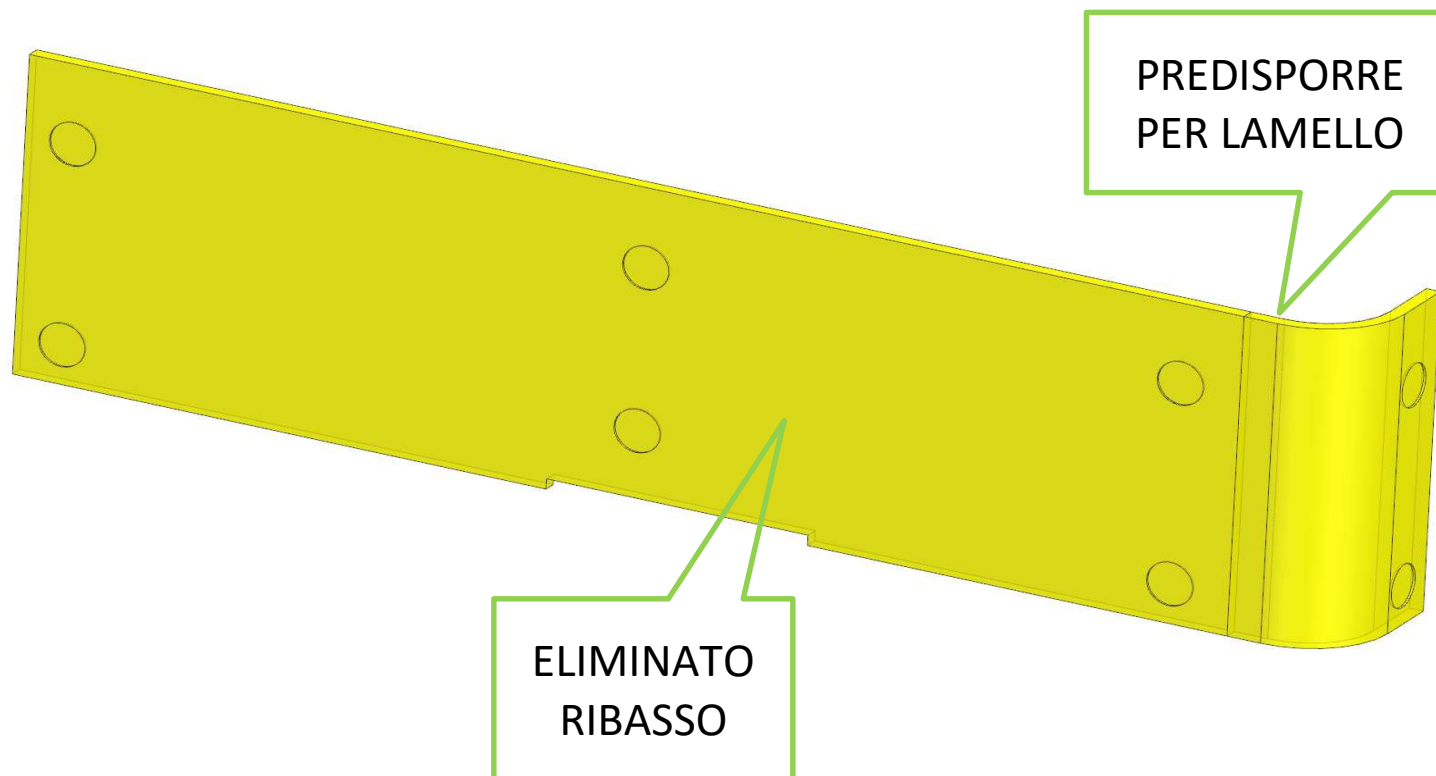

AZ68F

REV. 10-01-2022

LOCALE	CODICE	DESCRIZIONE COMPONENTE	FINITURA	Q.TA	OPERATORE
CABINA OSPITI DX	AZ68F-I01_RG01	LETTO CENTRO BARCA	OKOUME' GREZZO	1	Dante

1 - Sviluppo 2200 x H.225 x sp 15

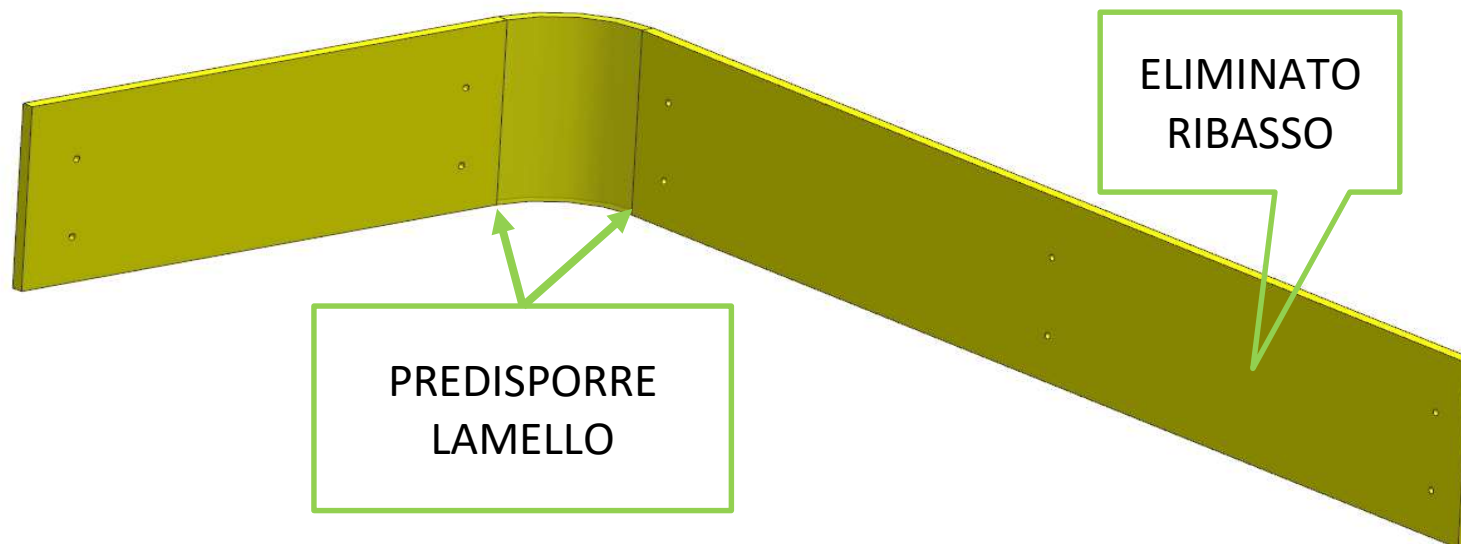

AZ68F

REV. 10-01-2022

LOCALE	CODICE	DESCRIZIONE COMPONENTE	FINITURA	Q.TA	OPERATORE
CABINA OSPITI DX	AZ68F-I01_RI01	CIELINO	OKOUME' GREZZO	3	Dante

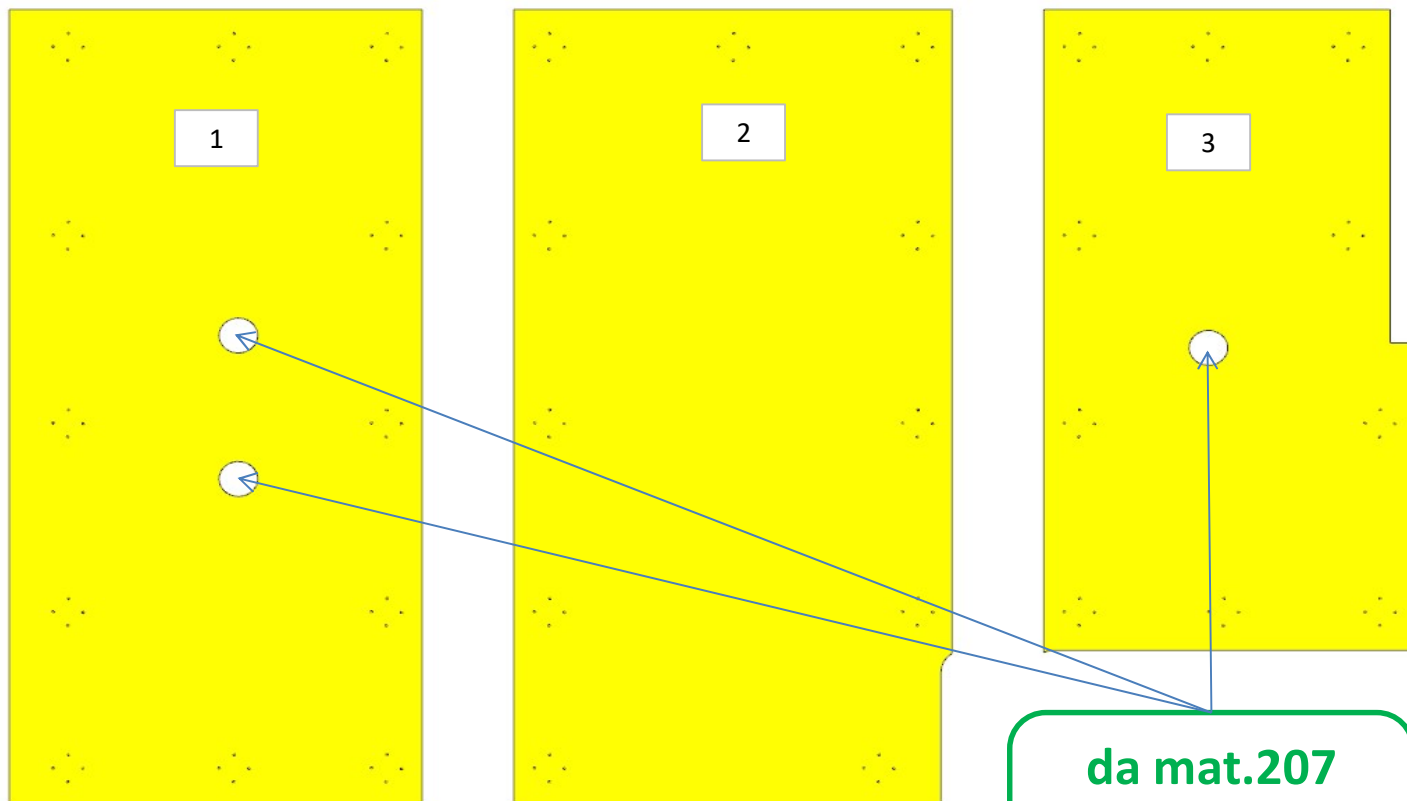

FERRAMENTA:

N° 33 - FITLOCK
MASCHIO

- 1 - L.689 x H 1475 x sp 10
- 2 - L.732 x H 1475 x sp 10
- 3 - L.578 x H 1192 x sp 10

da mat.207
AGGIUNTI FORI
FARETTI