

AZ68F

DA MAT. 211 REV. 29-04-2024

LOCALE	CODICE	DESCRIZIONE COMPONENTE	FINITURA	Q.TA	OPERATORE
CABINA ARMATORE	AZ68F-L03_AQ01	LETTO	LACCATO MOGANO 100 GLOSS	5	Damiano

1 - 5 - L.434 x H 30 x sp 30
2 - 4 - L 1431 x H 30 x sp 30
3 - L.1693 x H 30 x sp 30

**RICHIESTA AZIMUT
01/12/2021
CONSEGNARE ASSIEME
AL LETTO MA NON**

DETTAGLIO

AZ68F

DA MAT. 211 REV. 29-04-2024

LOCALE	CODICE	DESCRIZIONE COMPONENTE	FINITURA	Q.TA	OPERATORE
CABINA ARMATORE	AZ68F-MF_AR02	COMODINO POPPA			Damiano

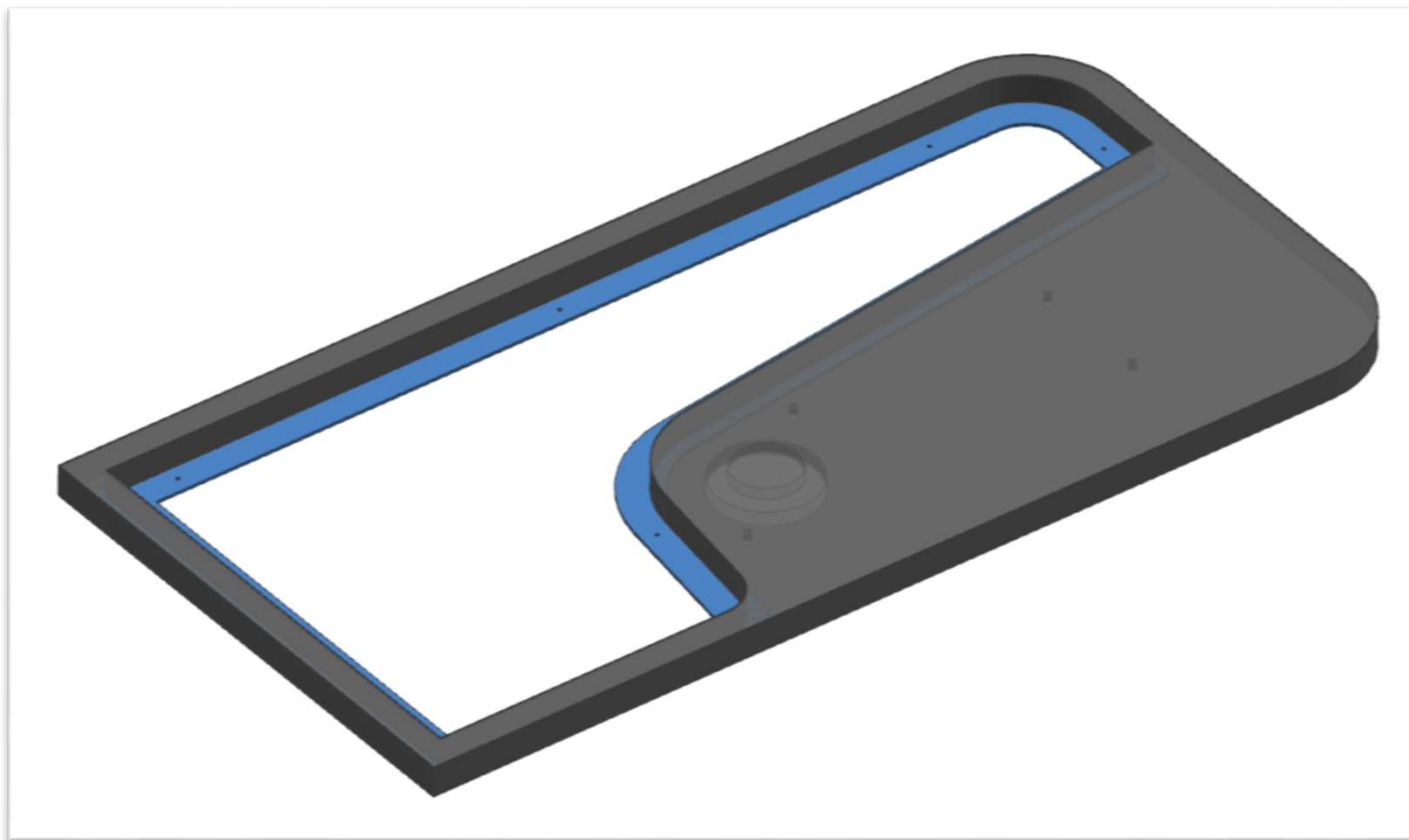

AZ68F

DA MAT. 203 REV. 29-04-2024

LOCALE	CODICE	DESCRIZIONE COMPONENTE	FINITURA	Q.TA	OPERATORE
CABINA ARMATORE	AZ68F-L03_AR01	COMODINO POPPA	LACCATO MOGANO 100 GLOSS	1	Damiano

1 - L 1064 x H 535 x sp 32

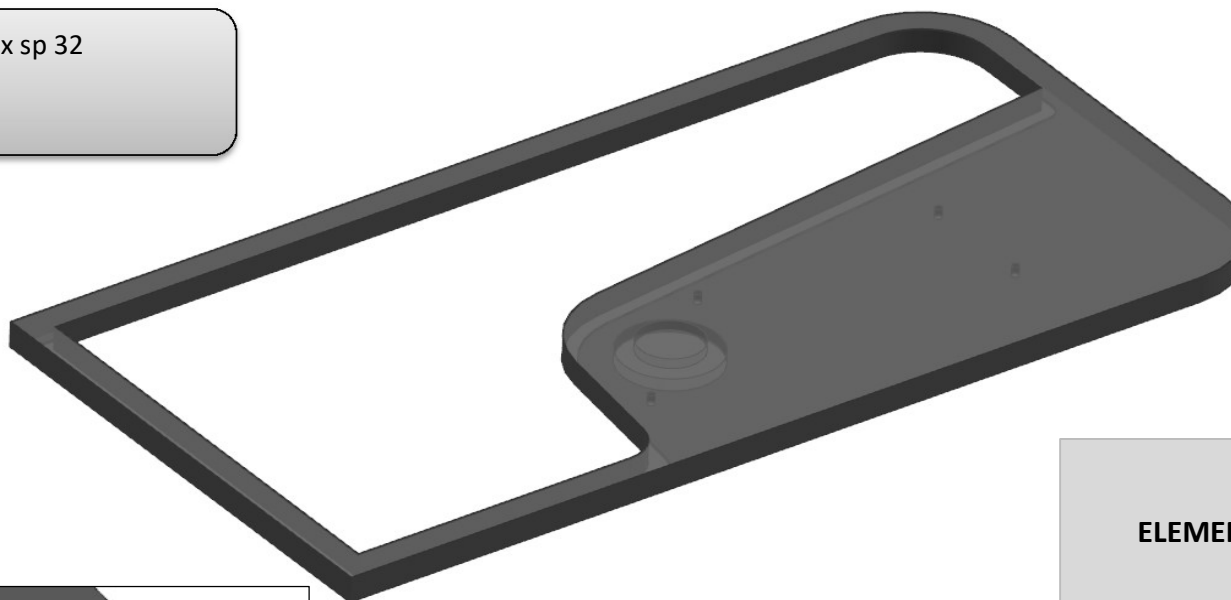

ELEMENTO DA MONTARE con:
X01_AR01
e spedire con un unico imballo

DETTAGLIO SEZIONE

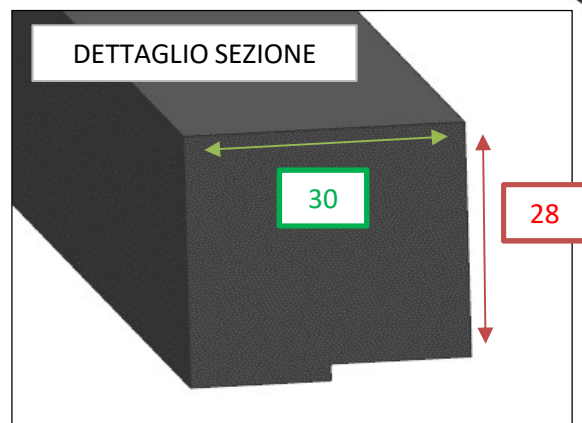

X01_AR01

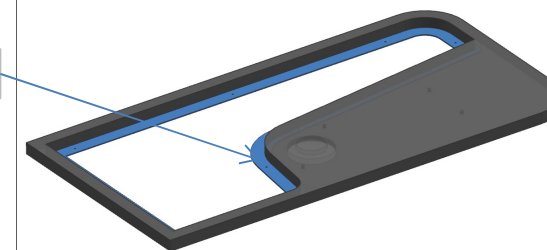

consonni&c

AZ68F

DA MAT. 203 REV. 29-04-2024

LOCALE	CODICE	DESCRIZIONE COMPONENTE	FINITURA	Q.TA	OPERATORE
CABINA ARMATORE	AZ68F-X01_AR01	COMODINO POPPA	LAMINATO NERO	1	Damiano

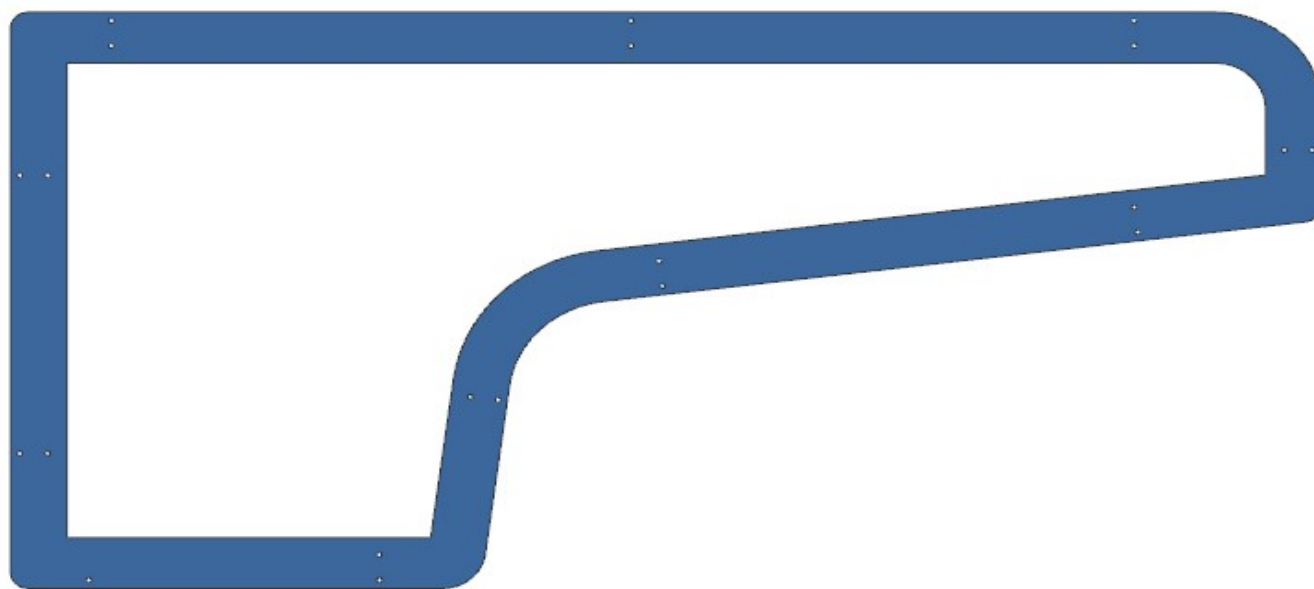

ELEMENTO DA MONTARE con:
L03_AR01
e spedire con un unico imballo

L03_AR01

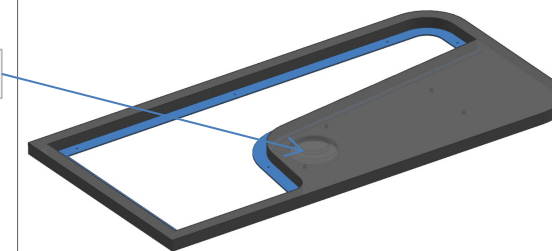

1 - L 1033 x H 504 x sp 3

AZ68F

DA MAT. 203 REV. 29-04-2024

LOCALE	CODICE	DESCRIZIONE COMPONENTE	FINITURA	Q.TA	OPERATORE
CABINA ARMATORE	AZ68F-MF_AS02	COMODINO PRUA			Damiano

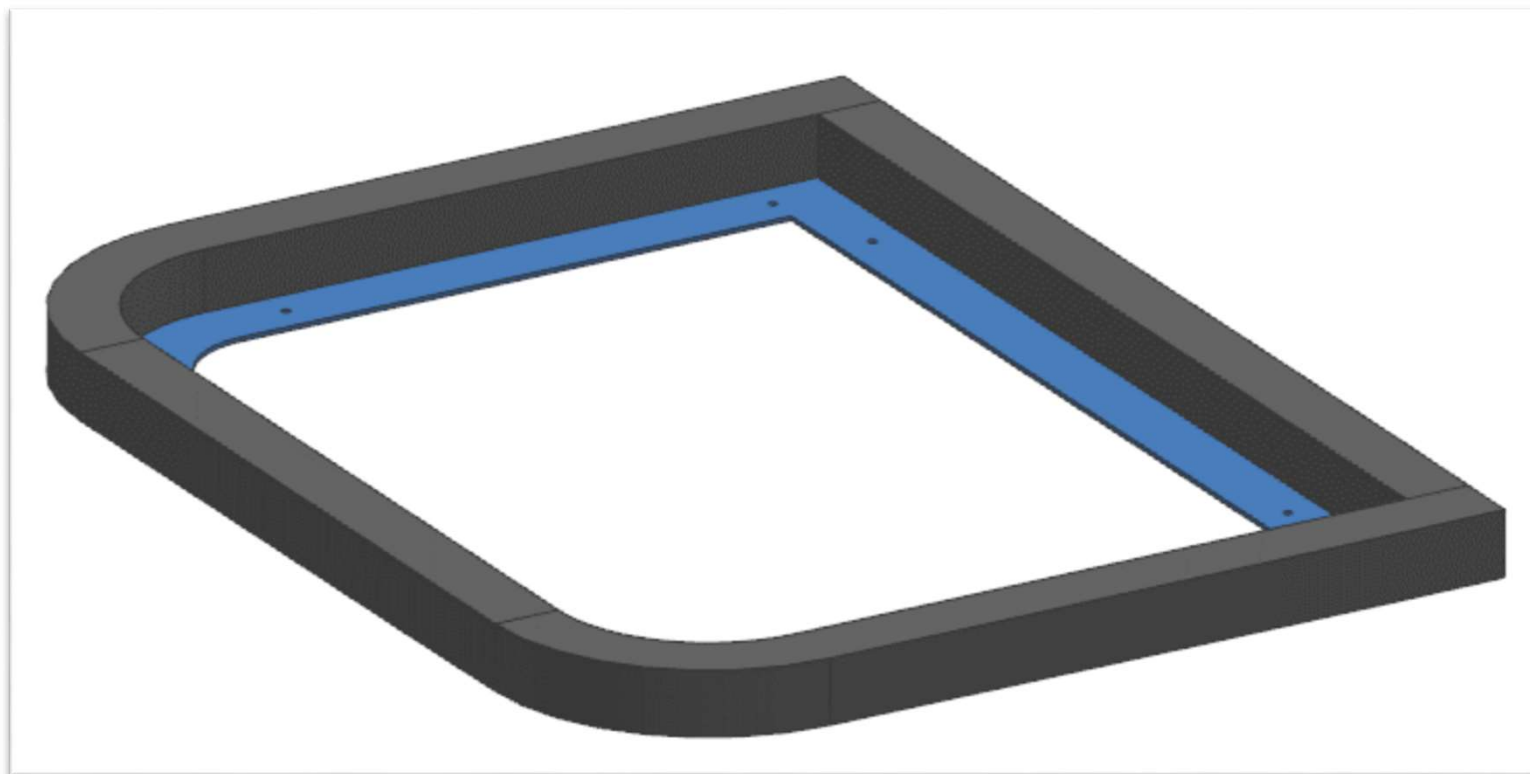

AZ68F

DA MAT. 203 REV. 29-04-2024

LOCALE	CODICE	DESCRIZIONE COMPONENTE	FINITURA	Q.TA	OPERATORE
CABINA ARMATORE	AZ68F-L03_AS01	COMODINO PRUA	LACCATO MOGANO 100 GLOSS	1	Damiano

1 - L 535 x H 420 x sp 32

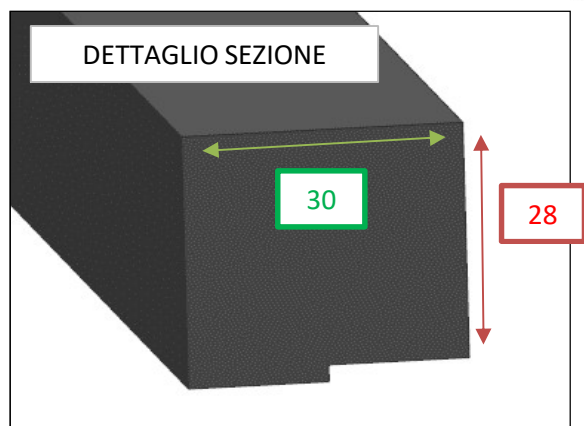
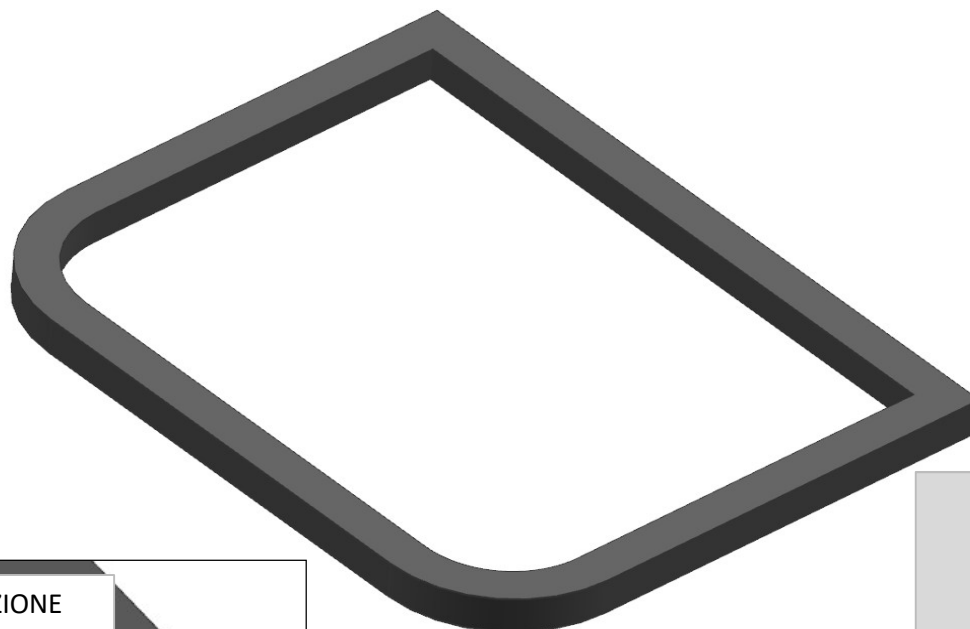

ELEMENTO DA MONTARE con:
X01_AS01
e spedire con un unico imballo

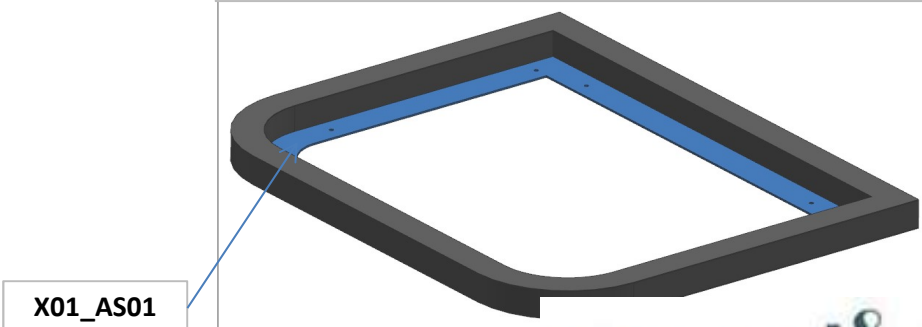

AZ68F

DA MAT. 203 REV. 29-04-2024

LOCALE	CODICE	DESCRIZIONE COMPONENTE	FINITURA	Q.TA	OPERATORE
CABINA ARMATORE	AZ68F-X01_AS01	COMODINO PRUA	LAMINATO NERO	1	Damiano

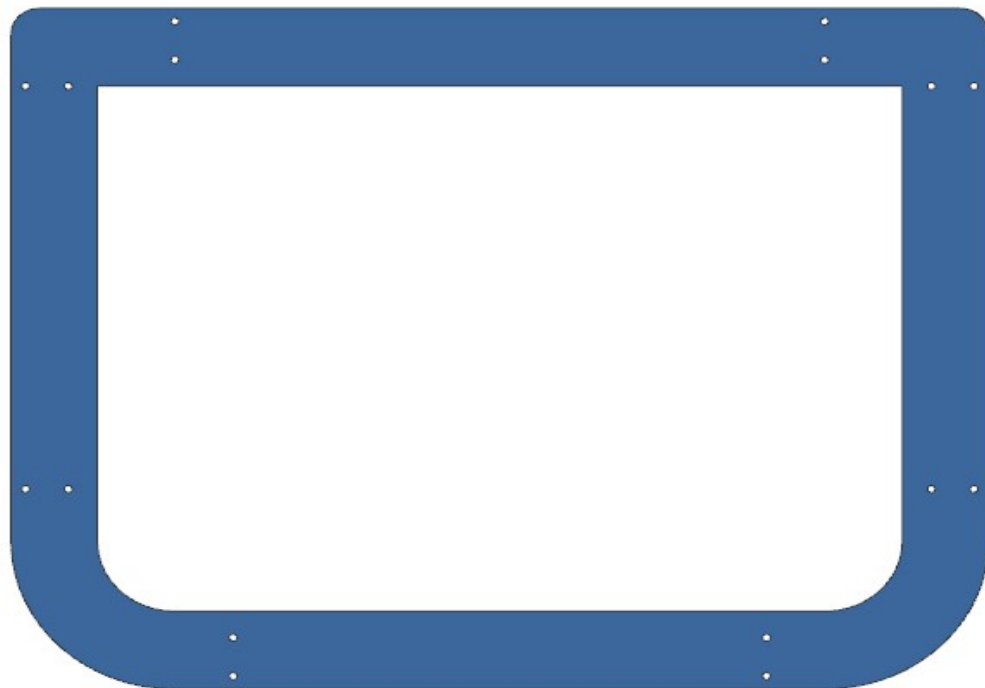

1 - L 504 x H.389 x sp 3

ELEMENTO DA MONTARE con:
L03_AS01
e spedire con un unico imballo

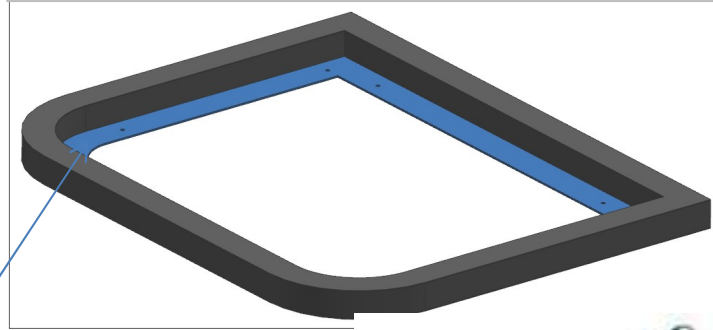

L03_AS01

AZ68F

REV. 29-04-2024

LOCALE	CODICE	DESCRIZIONE COMPONENTE	FINITURA	Q.TA	OPERATORE
CABINA ARMATORE	AZ68F-R01_AV01	CIELINO	LASTRA CHIARA	6	Damiano

133
MODIFICATA
SAGOMA

DA SPEDIRE CON IL MAIN
DECK

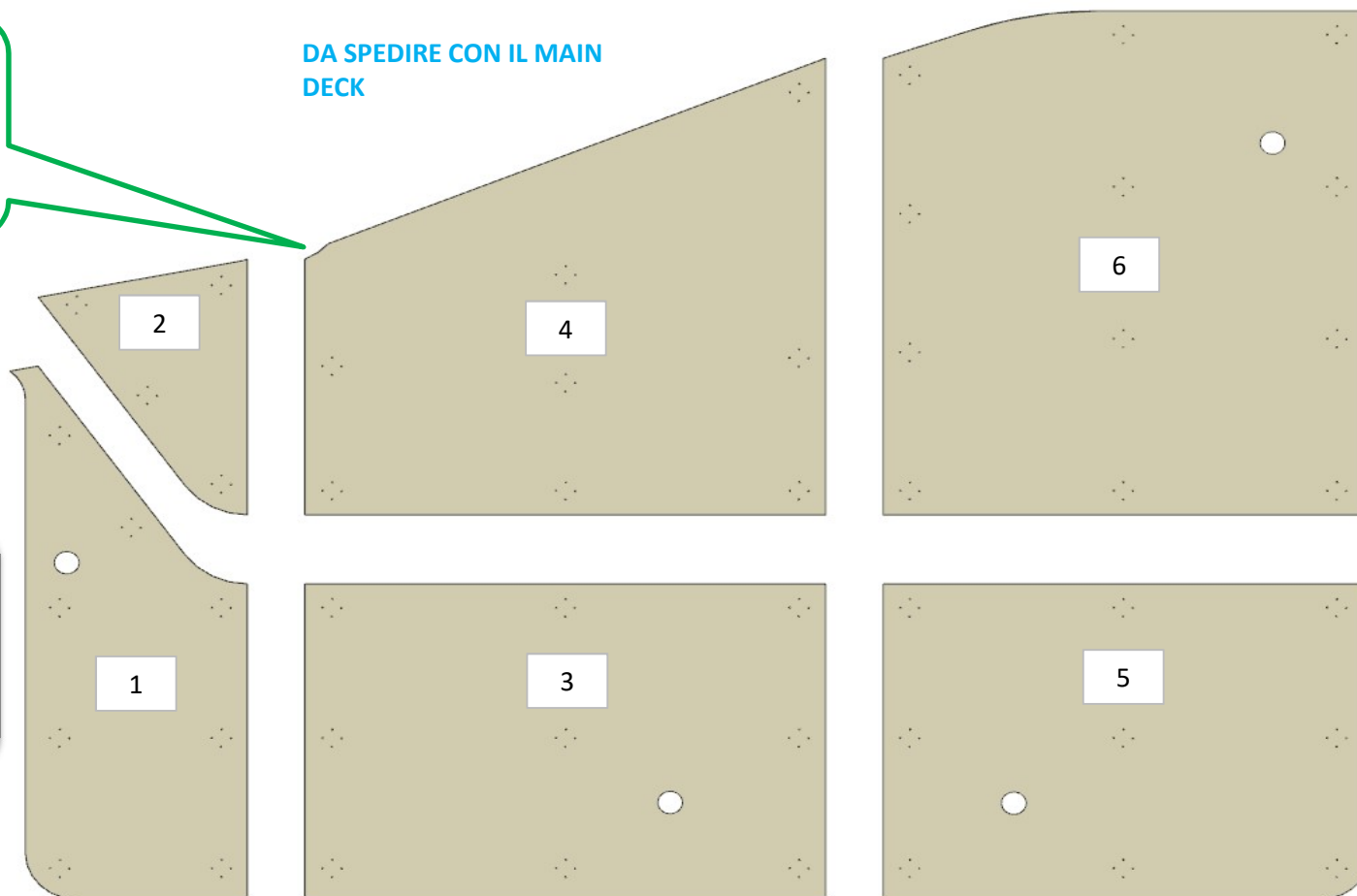

- 1 - L 622 x h 1532 x SP 16
- 2 - L.825 x H.509 x sp 16
- 3 - L.1364 x H 906 x sp 16
- 4 - L.1364 x H.1327 x sp 16
- 5 - L.1253 x H.904 x sp 16
- 6 - L.1259 x H.1466 x sp 16

FERRAMENTA:

N° 77 - FITLOCK MASCHIO

AZ68F

REV. 29-04-2024

LOCALE	CODICE	DESCRIZIONE COMPONENTE	FINITURA	Q.TA	OPERATORE
CABINA ARMATORE	AZ68F-L01_AV01	CIELINO	LACCATO BIANCO ARTICO	2	Damiano

1 - L 1286 x H 1999 x sp 16
2 - L 1265 x H 1467 x sp 16

ID-1344
RASARE E LACCARE
TUTTI I FILI

133
MODIFICATA
SAGOMA

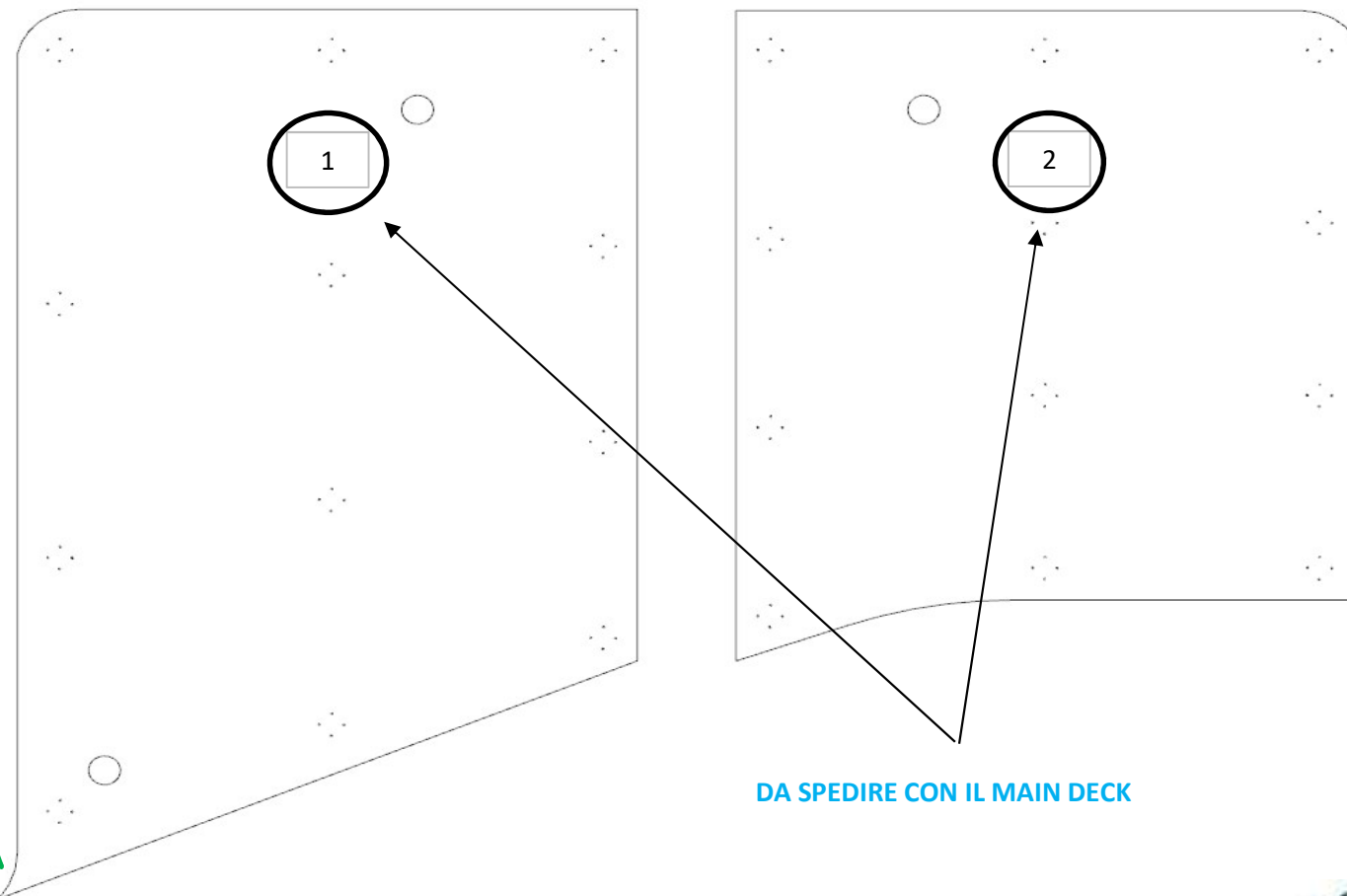

DA SPEDIRE CON IL MAIN DECK

AZ68F

DA MAT. 211 REV. 29-04-2024

LOCALE	CODICE	DESCRIZIONE COMPONENTE	FINITURA	Q.TA	OPERATORE
CABINA ARMATORE	AZ68F-MF_AAR02	COMODINO POPPA OPT			Damiano

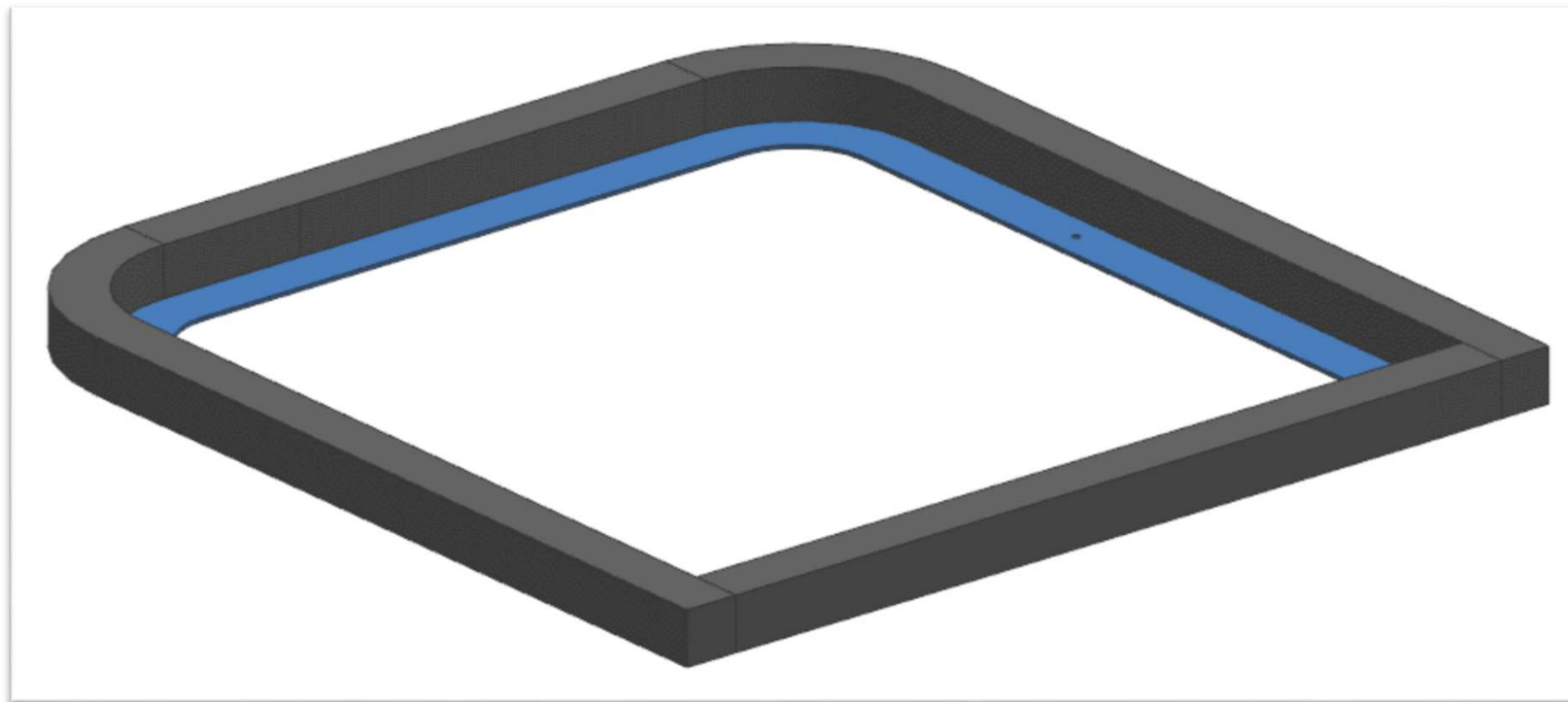

AZ68F

DA MAT. 265 REV. 29-04-2024

LOCALE	CODICE	DESCRIZIONE COMPONENTE	FINITURA	Q.TA	OPERATORE
CABINA ARMATORE	AZ68F-L03_AAR01	COMODINO POPPA OPT	LACCATO MOGANO 100 GLOSS	4	Damiano

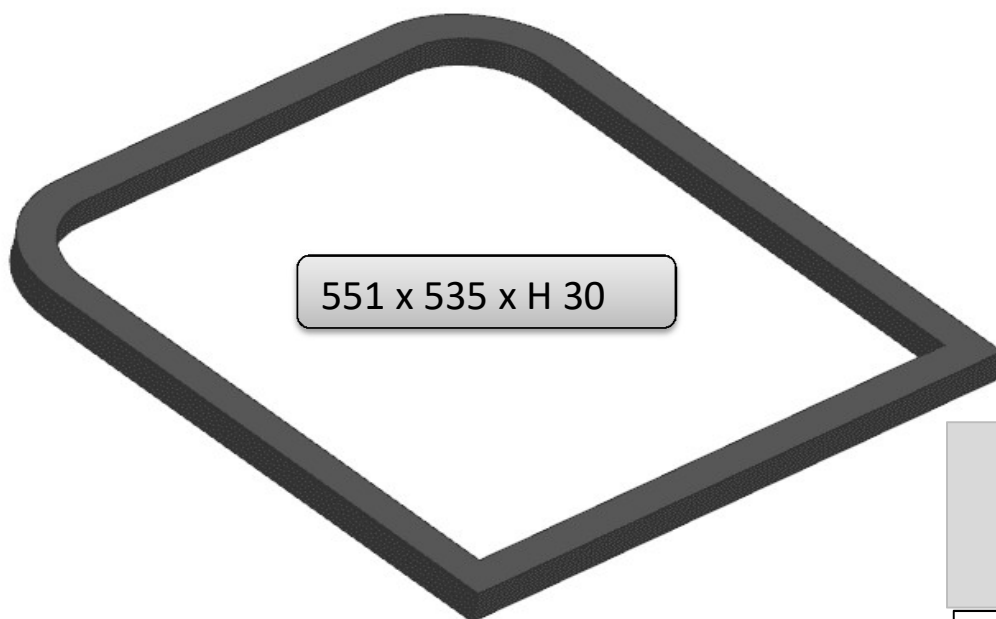

551 x 535 x H 30

ELEMENTO DA MONTARE con:
X01_AAR01
e spedire con un unico imballo

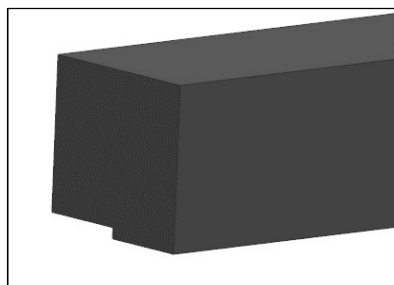

DETTAGLIO DI SEZIONE

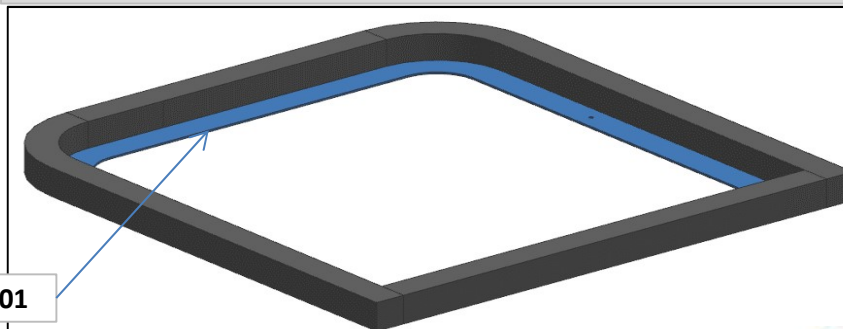

X01_AAR01

AZ68F

DA MAT. 203 REV. 29-04-2024

LOCALE	CODICE	DESCRIZIONE COMPONENTE	FINITURA	Q.TA	OPERATORE
CABINA ARMATORE	AZ68F-X01_AAR01	COMODINO POPPA OPT	LAMINATO NERO	1	Damiano

1 - L 520 x H 504 x sp 2

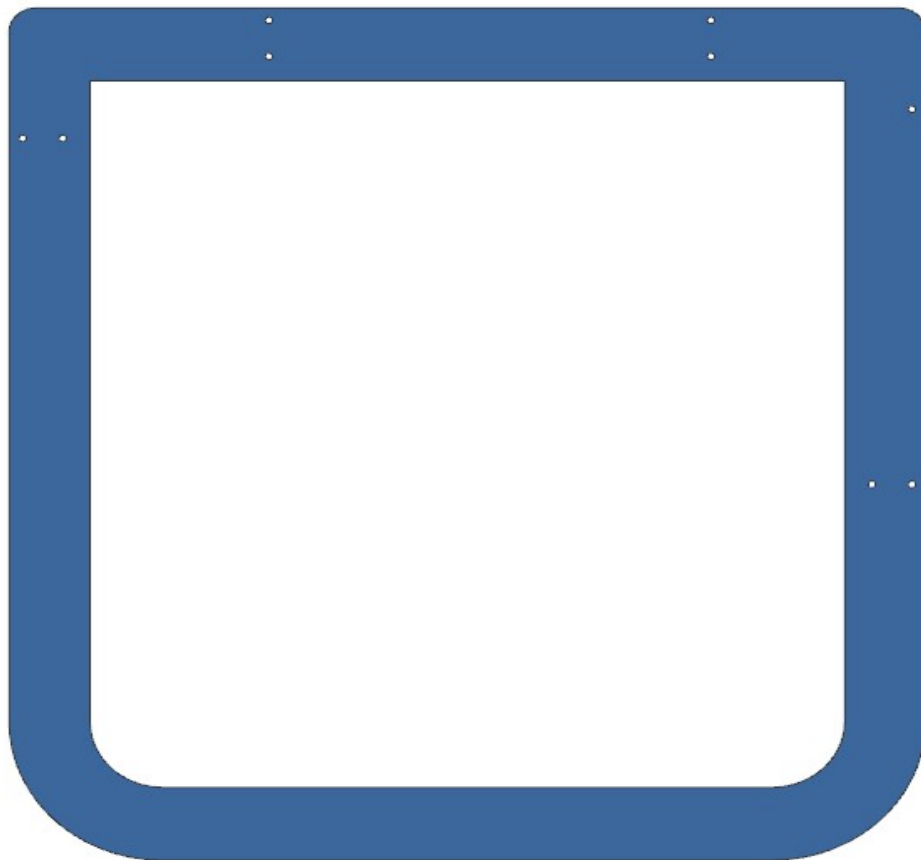

ELEMENTO DA MONTARE con:
X01_AAR01
e spedire con un unico imballo

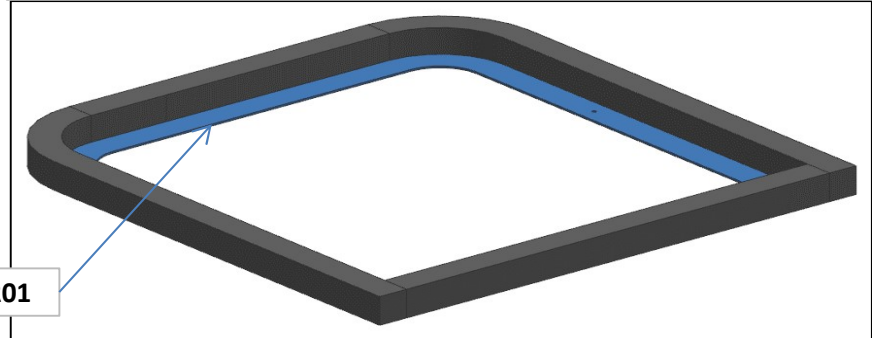

X01_AAR01

AZ68F

REV. 29-04-2024

LOCALE	CODICE	DESCRIZIONE COMPONENTE	FINITURA	Q.TA	OPERATORE
CABINA ARMATORE	AZ68F-R01_AAV01	CIELINO OPT	LASTRA CHIARA	4	Damiano

- 1 - L 1432 x H 929 x sp 16
- 2 - L 1328 x H 1481 x sp 16
- 3 - L 1278 x H 917 x sp 16
- 4 - L 1278 x H 1465 x sp 16

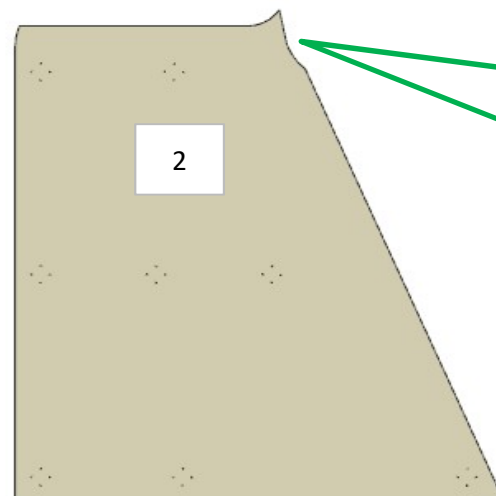
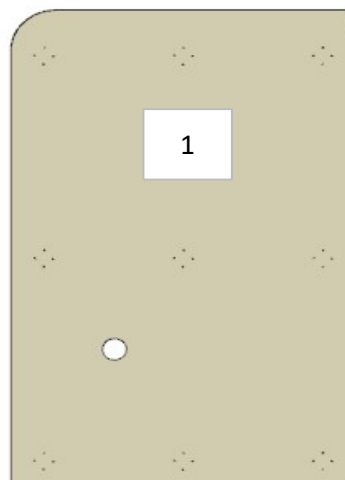

133
MODIFICATA
SAGOMA

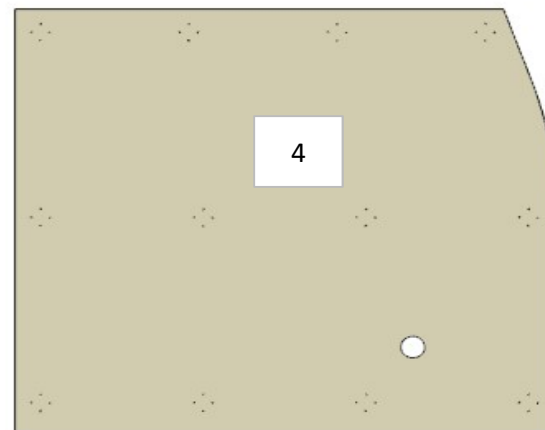
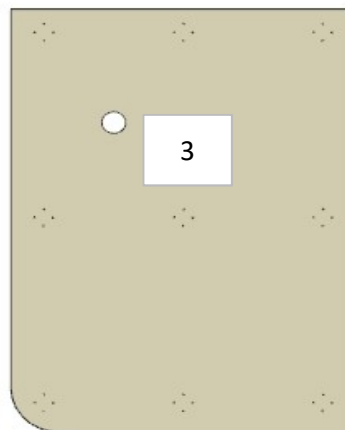

FERRAMENTA:

N° 38 - FITLOCK MASCHIO

AZ68F

DA MAT.216

REV. 29-04-2024

LOCALE	CODICE	DESCRIZIONE COMPONENTE	FINITURA	Q.TA	OPERATORE
BAGNO ARMATORE	AZ68F-MF_WC01	CIELINO LAVELLO			Damiano

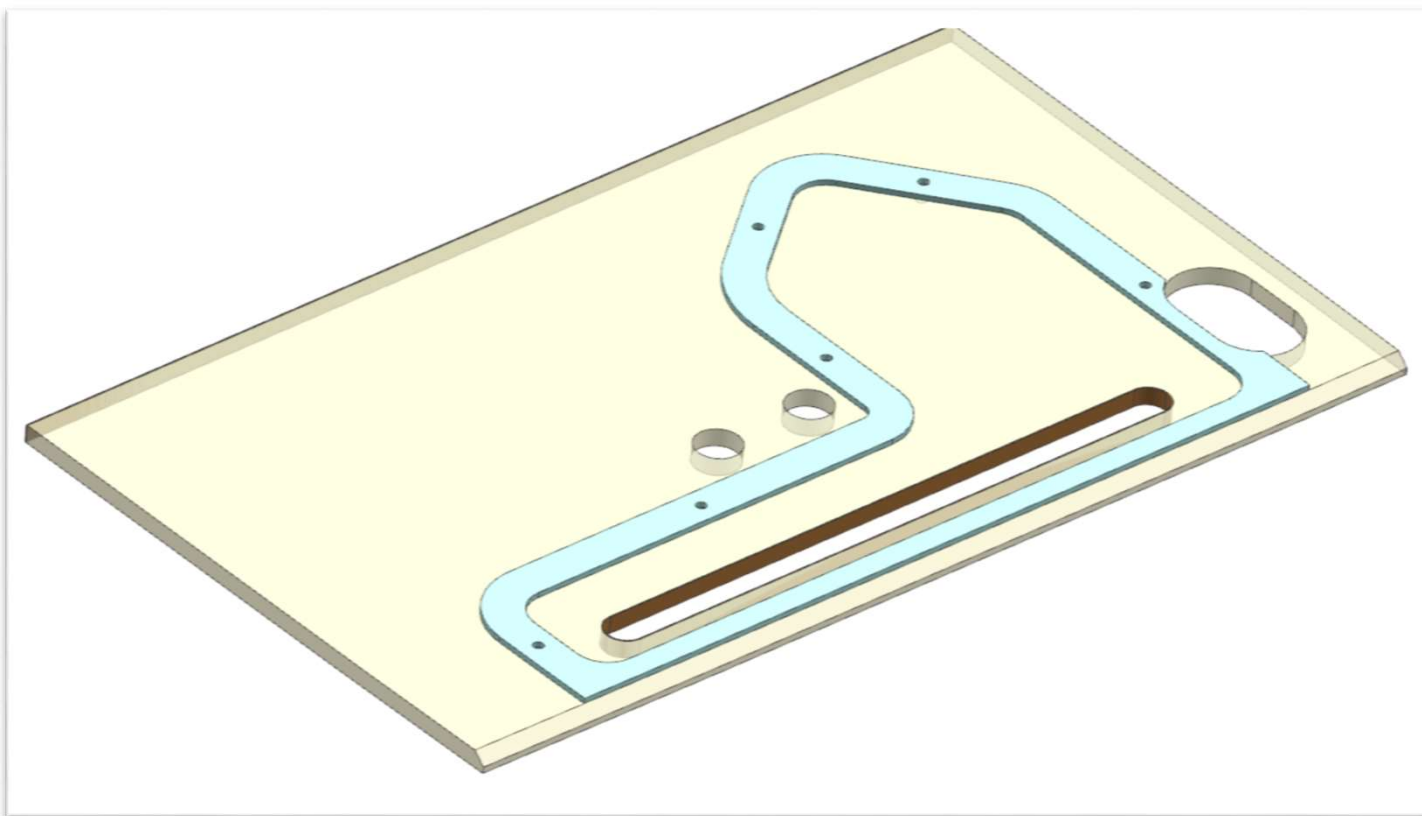

FERRAMENTA:

N° 6 - BUSSOLE ZAMA 6MA

AZ68F

DA MAT. 216 REV. 29-04-2024

LOCALE	CODICE	DESCRIZIONE COMPONENTE	FINITURA	Q.TA	OPERATORE
BAGNO ARMATORE	AZ68F-WC01	CIELINO LAVELLO	VERNICIATO NERO	1	Damiano

1 - L 636 x sp 5mm



180
MODIFICA SAGOMA

FERRAMENTA:

N° 6 - BUSSOLE ZAMA 6MA

ELEMENTO DA MONTARE con:
R01_WC01
e spedire con un unico imballo

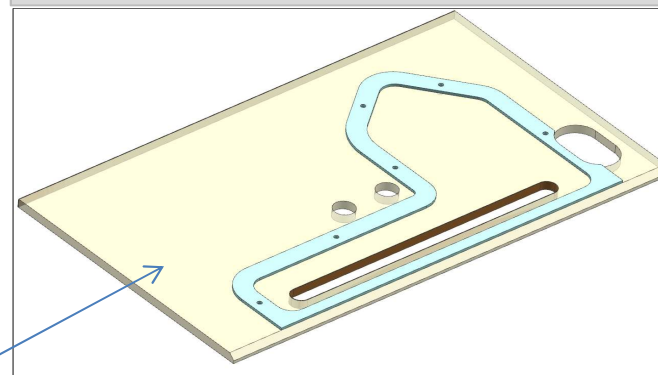

R01_WC01

AZ68F

DA MAT. 216 REV. 29-04-2024

LOCALE	CODICE	DESCRIZIONE COMPONENTE	FINITURA	Q.TA	OPERATORE
BAGNO ARMATORE	AZ68F-R01_WC01	CIELINO LAVELLO	LASTRA CHIARA	1	Damiano

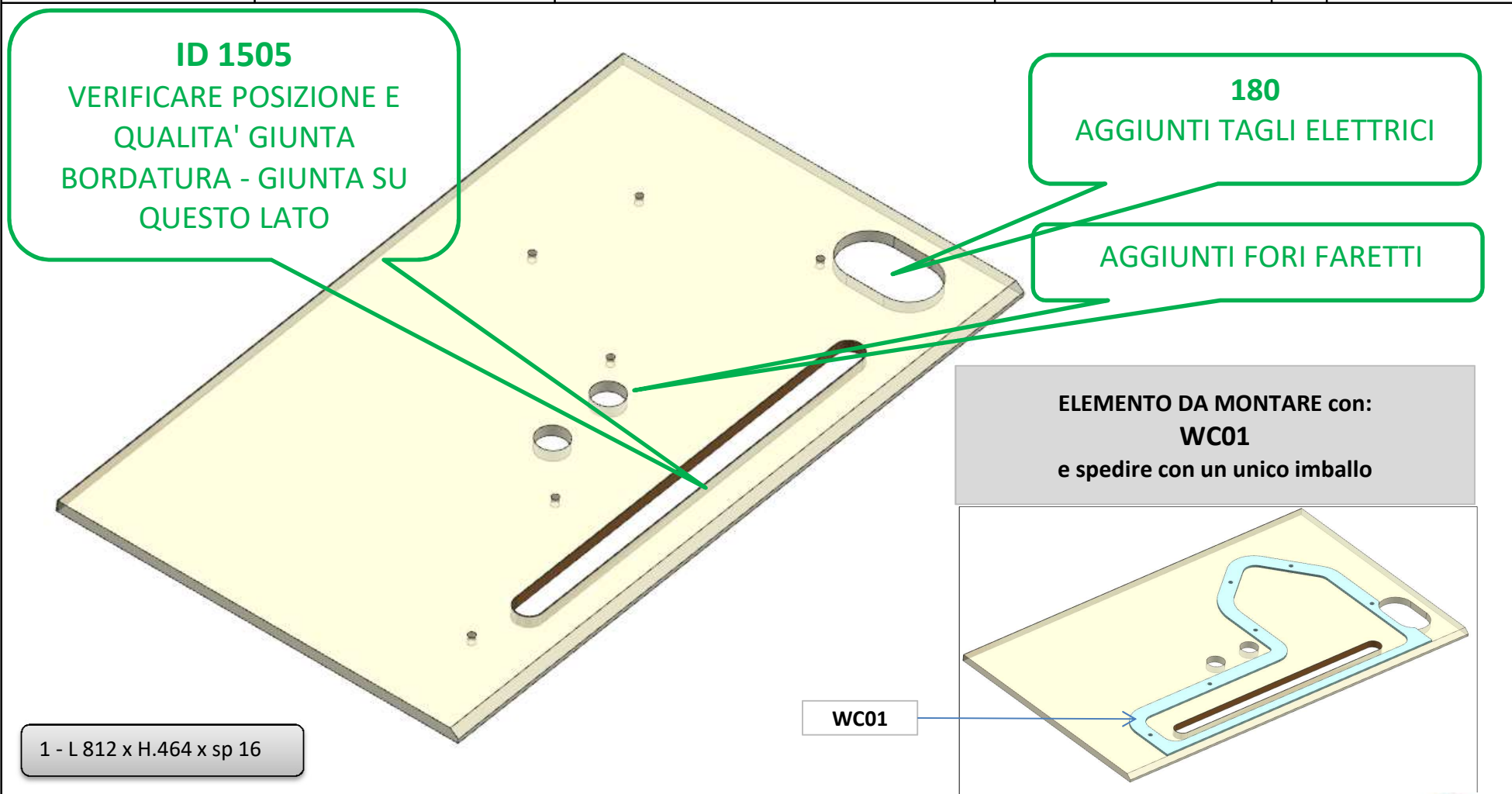

AZ68F

DA MAT. 215 REV. 29-04-2024

LOCALE	CODICE	DESCRIZIONE COMPONENTE	FINITURA	Q.TA	OPERATORE
BAGNO ARMATORE	AZ68F-L01_WO01	CIELINO DOCCIA	LACCATO BIANCO ARTICO	1	Damiano

1 - L 675 x H 534 x 10mm

FERRAMENTA:

N° 4 - FITLOCK MASCHIO

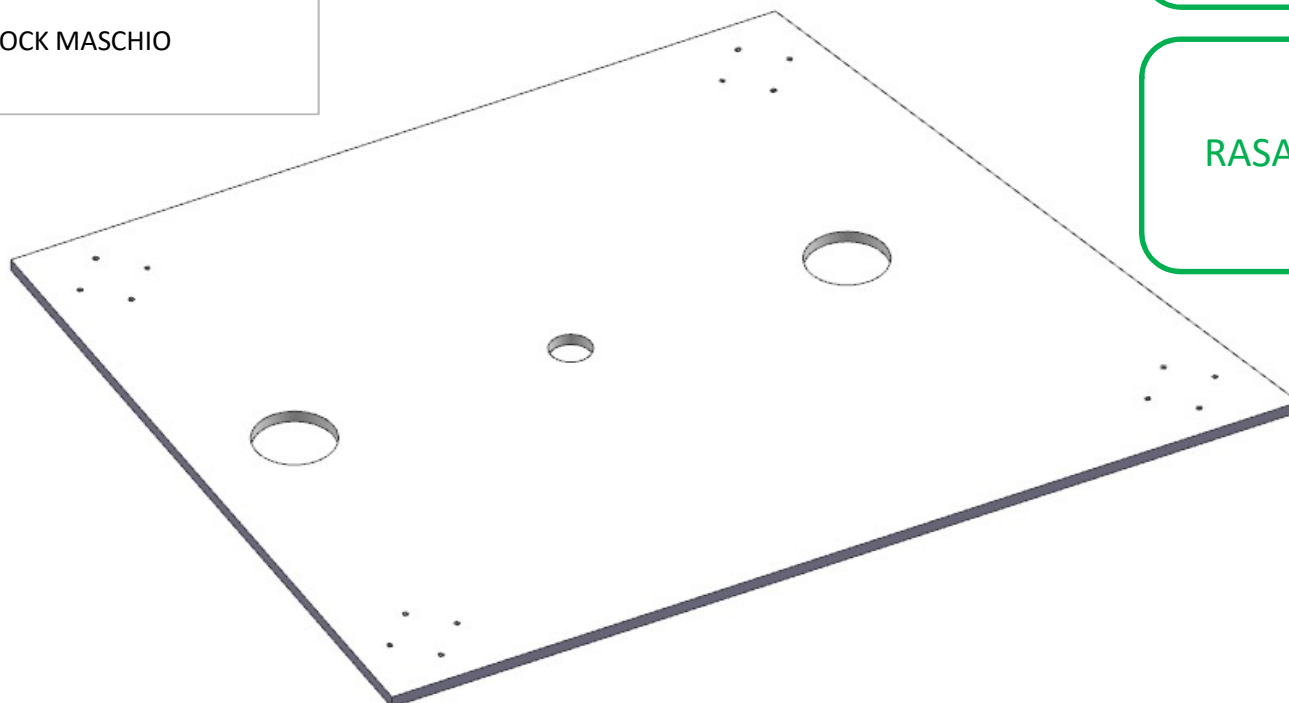

AGGIUNTO DA
MATRICOLA 215

ID-1344
RASARE E LACCARE TUTTI I
FILII

AZ68F

DA MAT. 203 REV. 29-04-2024

LOCALE	CODICE	DESCRIZIONE COMPONENTE	FINITURA	Q.TA	OPERATORE
CABINA VIP	AZ68F-L01_VA01	LETTO	LACCATO BRONZO	3	Damiano

1 - 3 - L.839 x H 30 x sp 30
2 - L 1694 x H 30 x sp 30



AZ68F

REV. 29-04-2024

LOCALE	CODICE	DESCRIZIONE COMPONENTE	FINITURA	Q.TA	OPERATORE
CABINA VIP	AZ68F-L01_VE01	VASSOIO SX	LACCATO ABALONE	1	Damiano



AZ68F

REV. 29-04-2024

LOCALE	CODICE	DESCRIZIONE COMPONENTE	FINITURA	Q.TA	OPERATORE
CABINA VIP	AZ68F-L01_VL01	VASSOIO DX	LACCATO ABALONE	1	Damiano

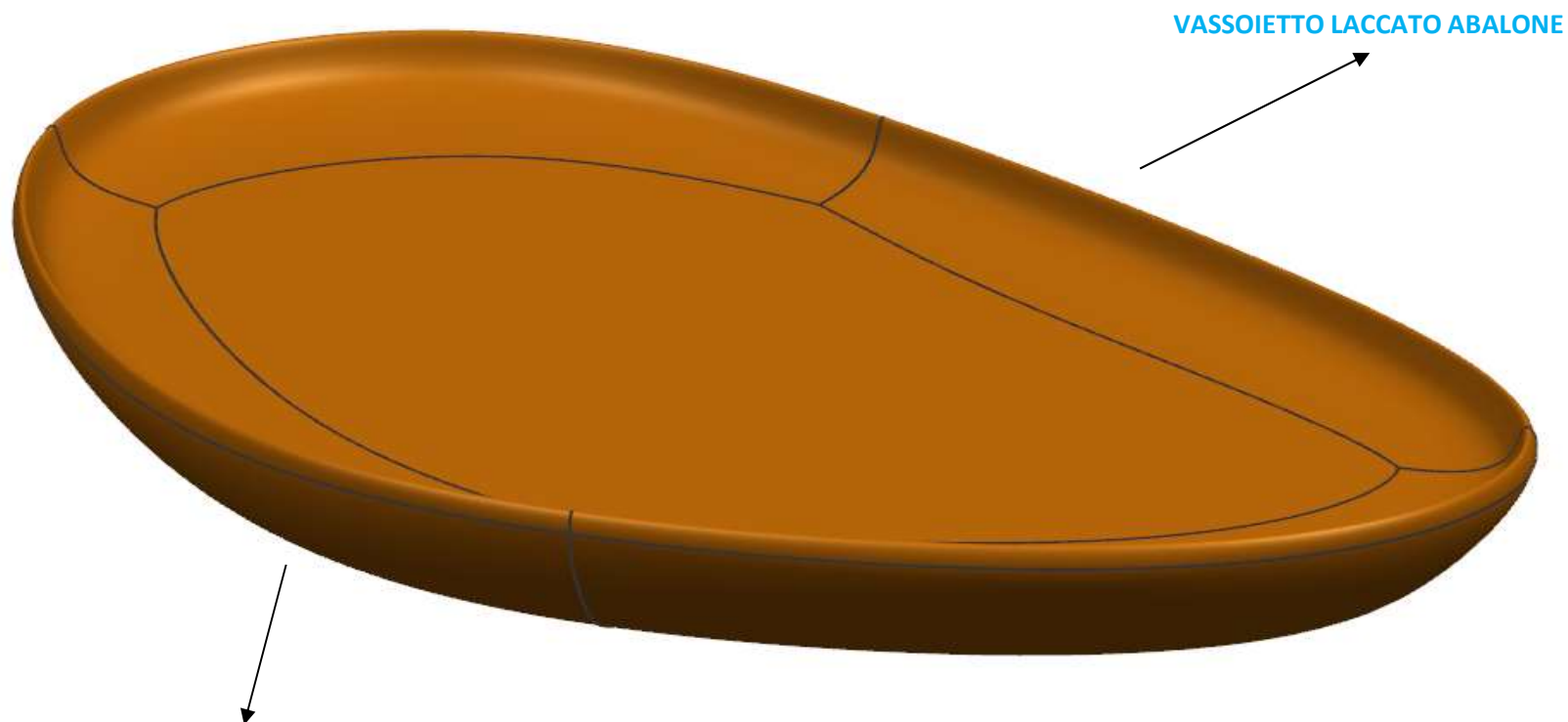

VASSOINETTO LACCATO ABALONE

DA SPEDIRE CON IL MAIN DECK

AZ68F

DA MAT.237

REV. 29-04-2024

LOCALE	CODICE	DESCRIZIONE COMPONENTE	FINITURA	Q.TA	OPERATORE
CABINA VIP	AZ68F-MG_VP01	CIELINO			Damiano

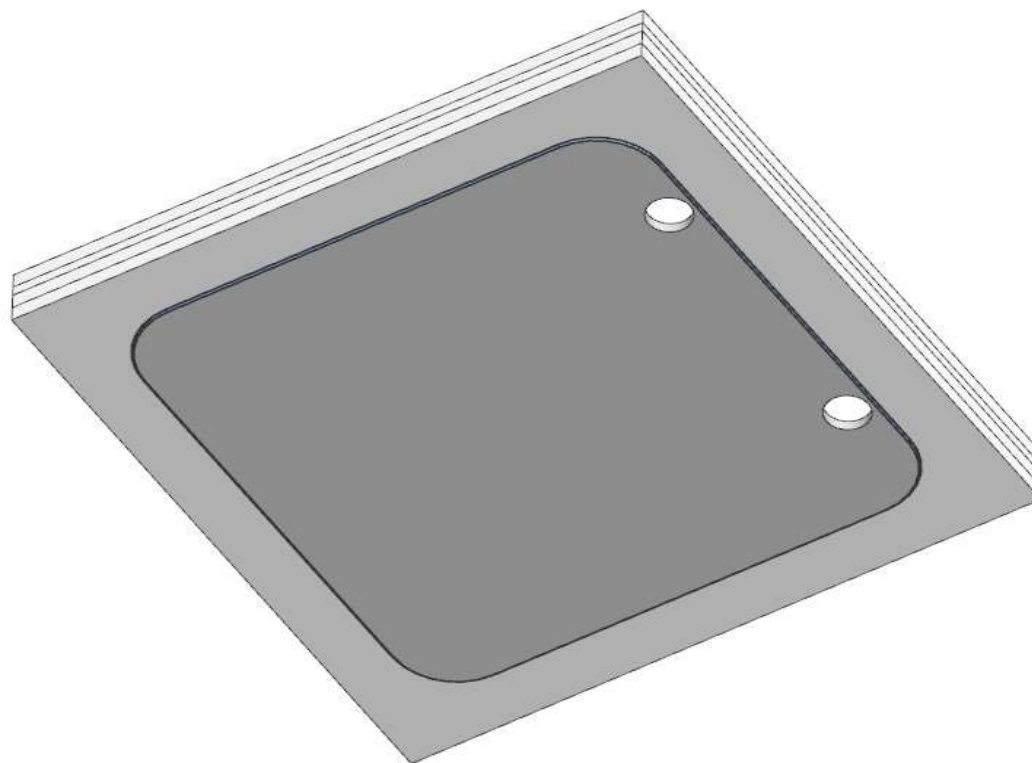

FERRAMENTA:

N° 2 - CERNIERA TAGLIO 45°

N° 2 - BASETTA H0

N°1 - KIT PUSH ROTANTE

AZ68F

DA MAT.237

REV. 29-04-2024

LOCALE	CODICE	DESCRIZIONE COMPONENTE	FINITURA	Q.TA	OPERATORE
CABINA VIP	AZ68F-L01_VP01	CIELINO	LACCATO BIANCO ARTICO	2	Damiano

DA SPEDIRE CON IL MAIN DECK

1 - L.525 x H 524 x sp 55mm
2 - L 430 x H 427 x sp 10mm

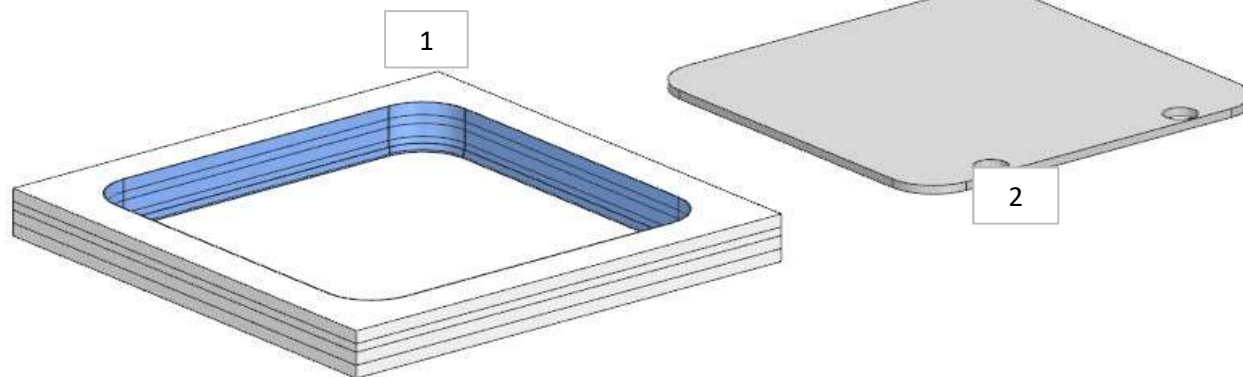

ELEMENTO DA MONTARE :
MG_VP01
e spedire con un unico imballo

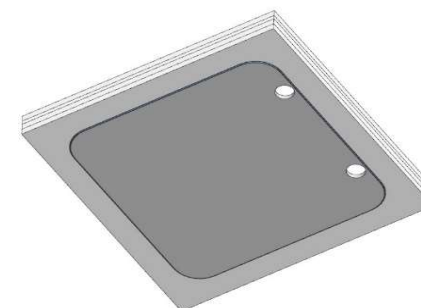

FERRAMENTA:
N° 2 - CERNIERA TAGLIO 45°
N° 2 - BASETTA H0
N°1 - KIT PUSH ROTANTE

AZ68F

DA MAT. 216 REV. 29-04-2024

LOCALE	CODICE	DESCRIZIONE COMPONENTE	FINITURA	Q.TA	OPERATORE
BAGNO VIP	AZ68F-L01_JH01	CIELINI BAGNO	LACCATO BIANCO ARTICO	2	Damiano

1 - L.1364 x H 1077 x sp 12
2 - L.692 x H 640 x sp 12

da mat.207
AGGIUNTI FORI
FARETTI

ID-1344
RASARE E LACCARE
TUTTI I FILI

FERRAMENTA:

N° 15 - FITLOCK MASCHIO
N° 15 - FITLOCK FEMMINA

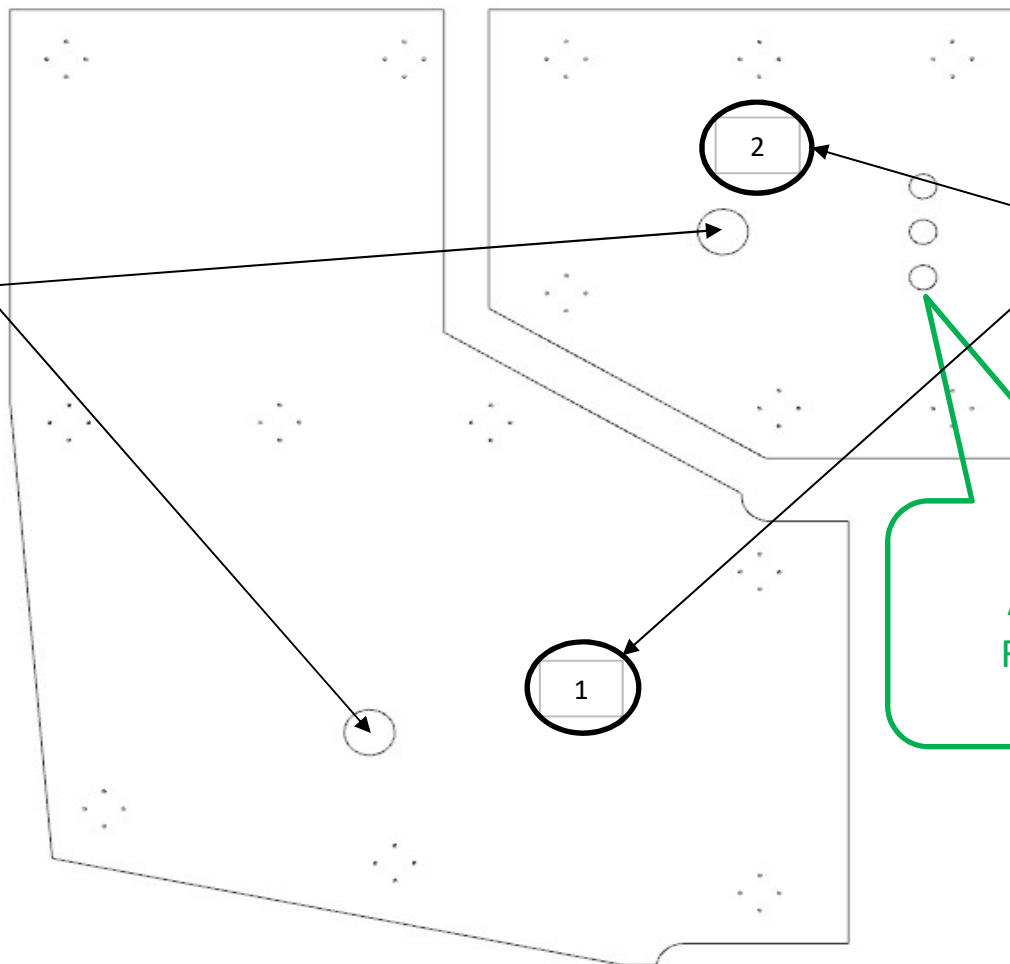

DA SPEDIRE CON IL
MAIN DECK

169-170
AGGIUNTI FORI
RICIRCOLO ARIA

AZ68F

REV. 15-11-2022

LOCALE	CODICE	DESCRIZIONE COMPONENTE	FINITURA	Q.TA	OPERATORE
CABINA OSPITI SX	AZ68F-L01_LL01	VASSOIETTO	LACCATO BRONZO	1	Damiano

1 - diametro 204

VASSOIETTO LACCATO ABALONE

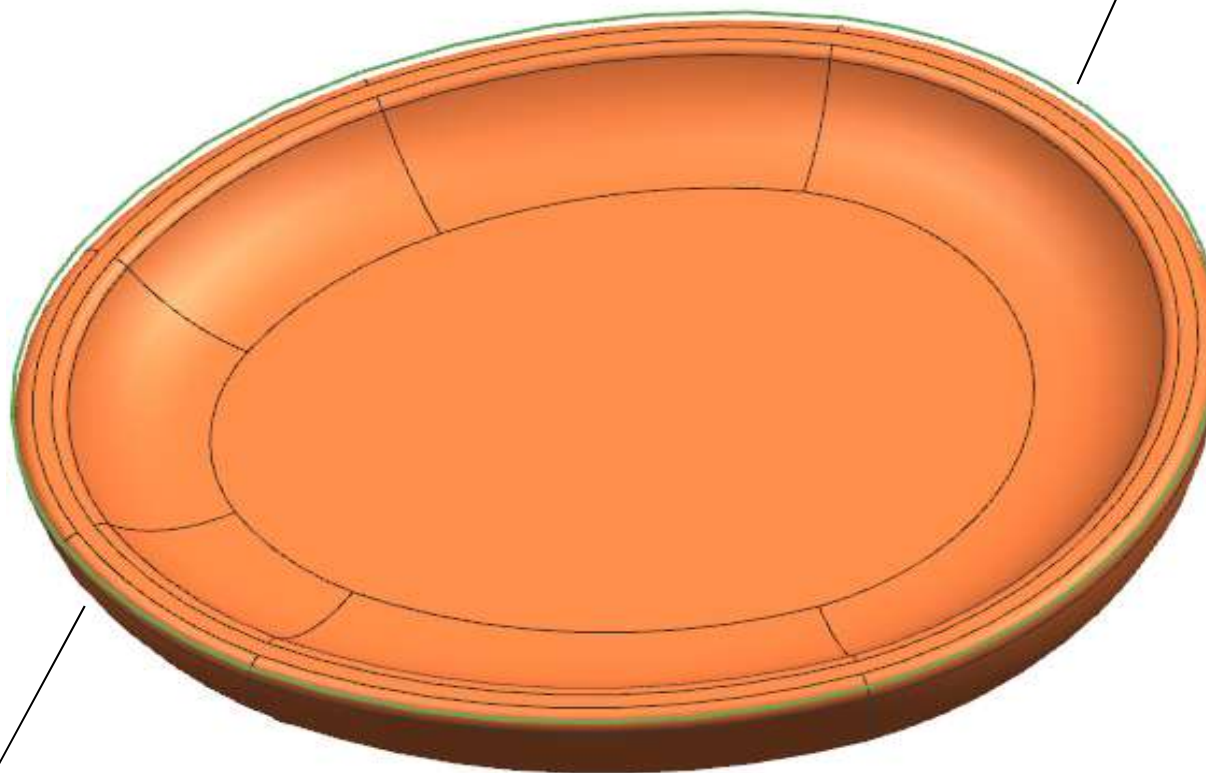

DA SPEDIRE CON IL MAIN DECK

consonni&c

AZ68F

REV. 10-01-2022

LOCALE	CODICE	DESCRIZIONE COMPONENTE	FINITURA	Q.TA	OPERATORE
CABINA OSPITI DX	AZ68F-L01_RL01	VASSOIETTO	LACCATO ABALONE	1	Damiano

1 - diametro 204

VASSOIETTO LACCATO
ABALONE

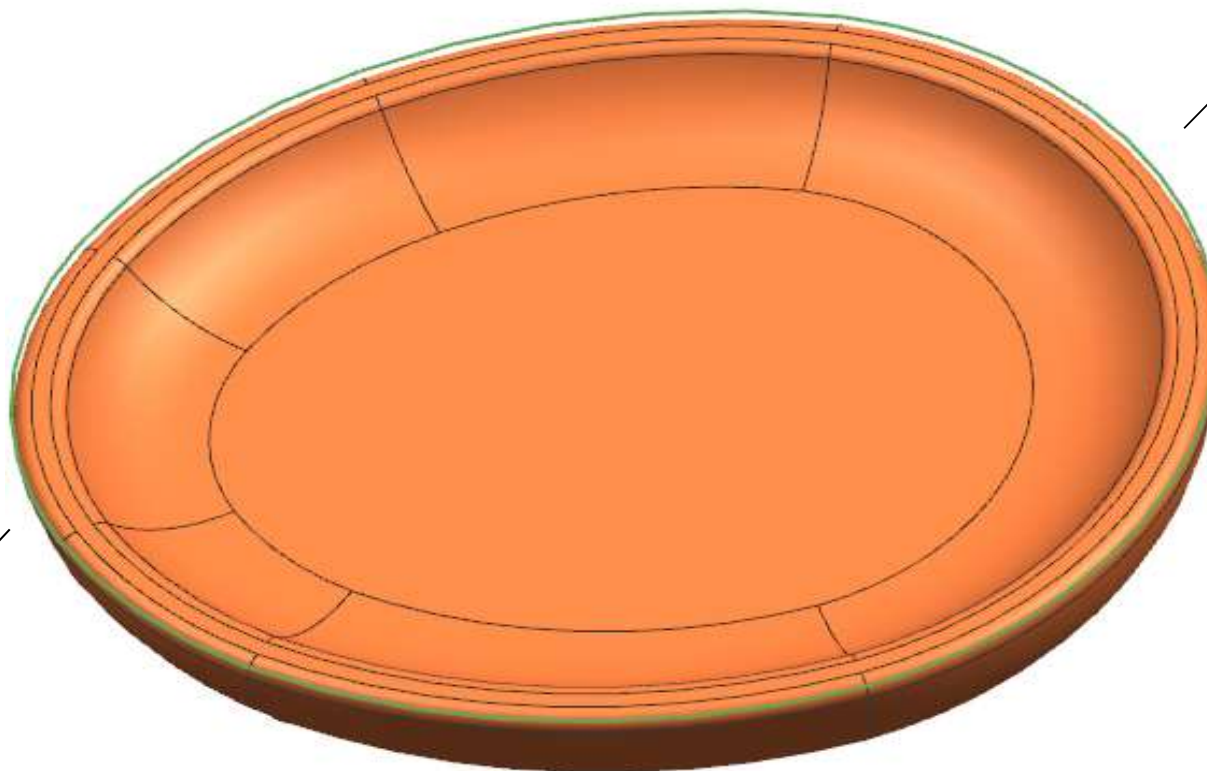

DA SPEDIRE CON IL
MAIN DECK

consonni&c

AZ68F

DA MAT. 216 REV. 29-04-2024

LOCALE	CODICE	DESCRIZIONE COMPONENTE	FINITURA	Q.TA	OPERATORE
BAGNO OSPITI	AZ68F-L01_ZH01	CIELINO BAGNO	LACCATO BIANCO ARTICO	2	Damiano

1 - L.1327 x H 670 x sp 12
2 - L.1342 x H 630 x sp 12

da mat.207
AGGIUNTI FORI
FARETTI

ID-1344
RASARE E LACCARE
TUTTI I FILI

FERRAMENTA:
N° 29 - FITLOCK MASCHIO

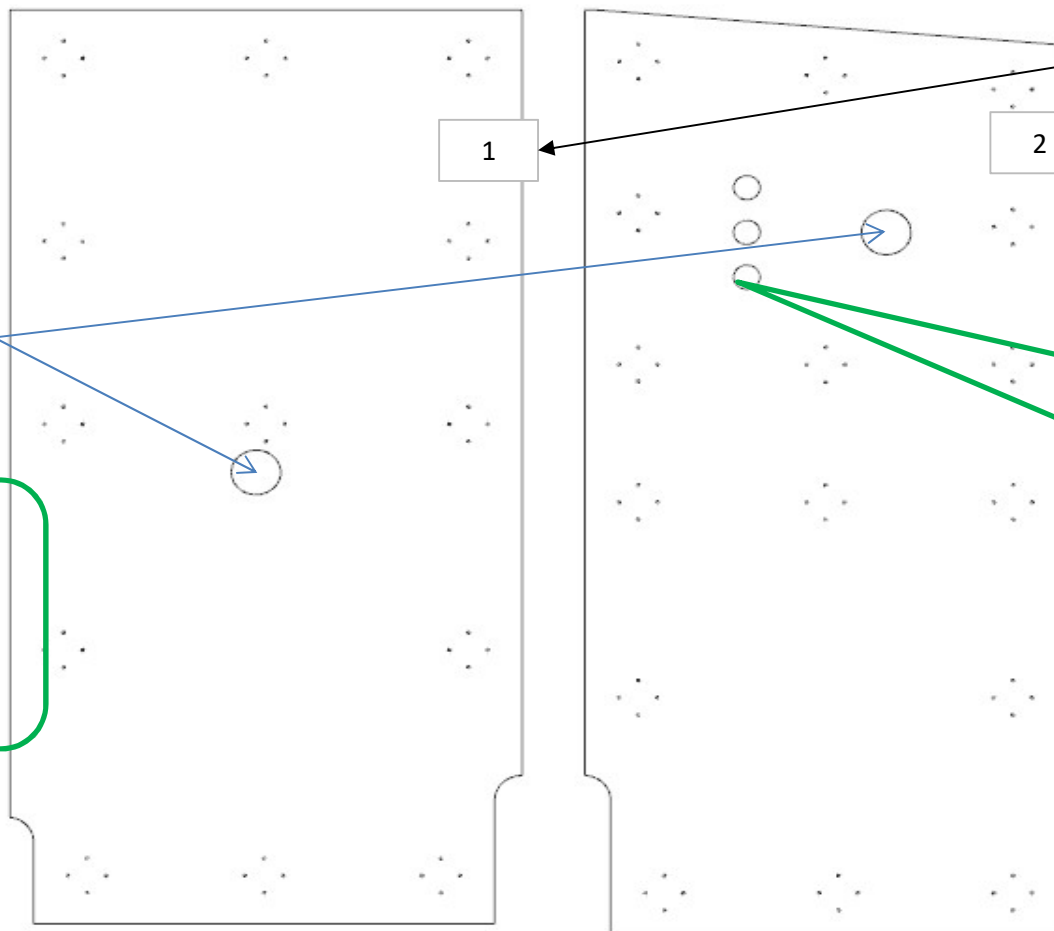

DA SPEDIRE CON
IL MAIN DECK

FACCIA SENZA FITLOCK E
FILI TUTTI

MOD. INT.
AGGIUNTI FORI
RICIRCOLO ARIA

AZ68F

Prototipo 12-2020

LOCALE	CODICE	DESCRIZIONE COMPONENTE	FINITURA	Q.TA	OPERATORE
LOBBY	AZ68F-L01_CC01	CELINO	LACCATO BIANCO ARTICO	1	Damiano

1 - L.1468 x H611 x sp 10

DA SPEDIRE NEL MAIN DECK

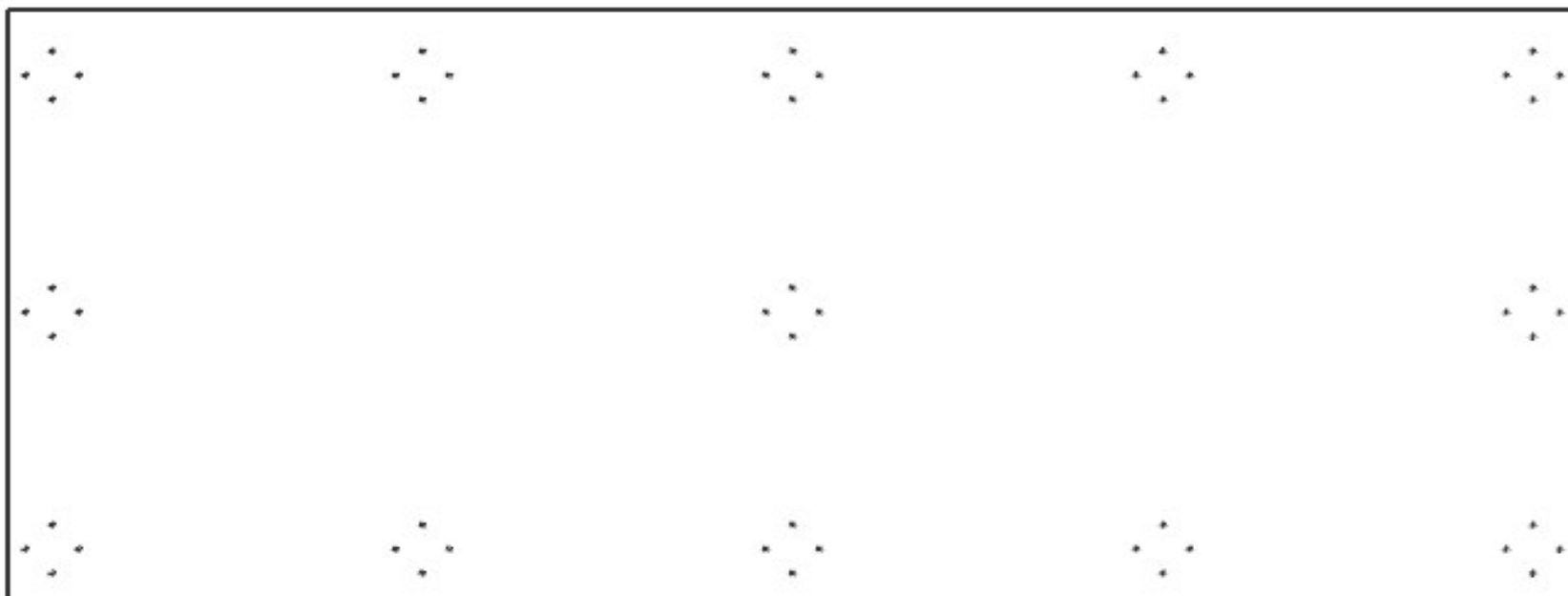

FERRAMENTA:

N° 13 - FITLOCK MASCHIO