

AZ26M

REV. GR 9

LOCALE	CODICE	DESCRIZIONE COMPONENTE	FINITURA	Q.TA	OPERATORE
CABINA OSPITI DX	AZ26M-MG_RA01\RA02	STRUTTURA MURATA TESTATA LETTO			Damiano

MG_RA01

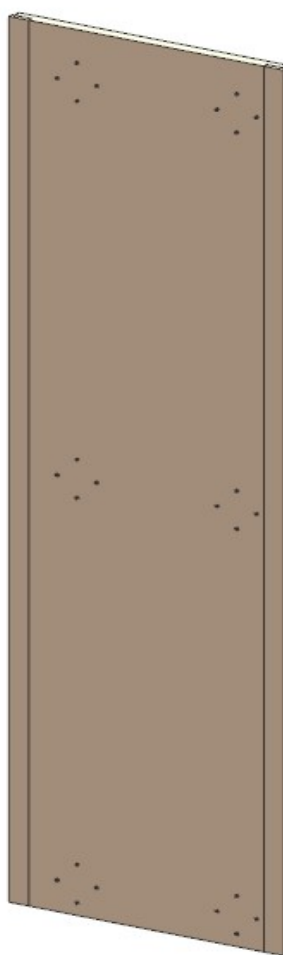

MG_RA02

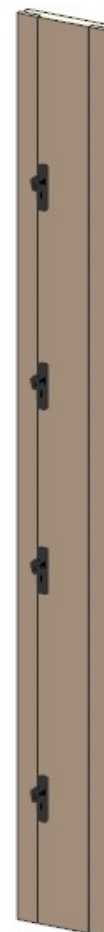

FERRAMENTA:

N° 2 - FLUSH LOCK
N° 4 - KEKU ESTRAZIONE
FRONTALE COPPIA M/F

AZ26M

REV. 01-2023

REV. GR 9

LOCALE	CODICE	DESCRIZIONE COMPONENTE	FINITURA	Q.TA	OPERATORE
CABINA OSPITI DX	AZ26M-MG_RC01	STRUTTURA LETTO			Dante

**NON MONTARE
QUESTO PEZZO**

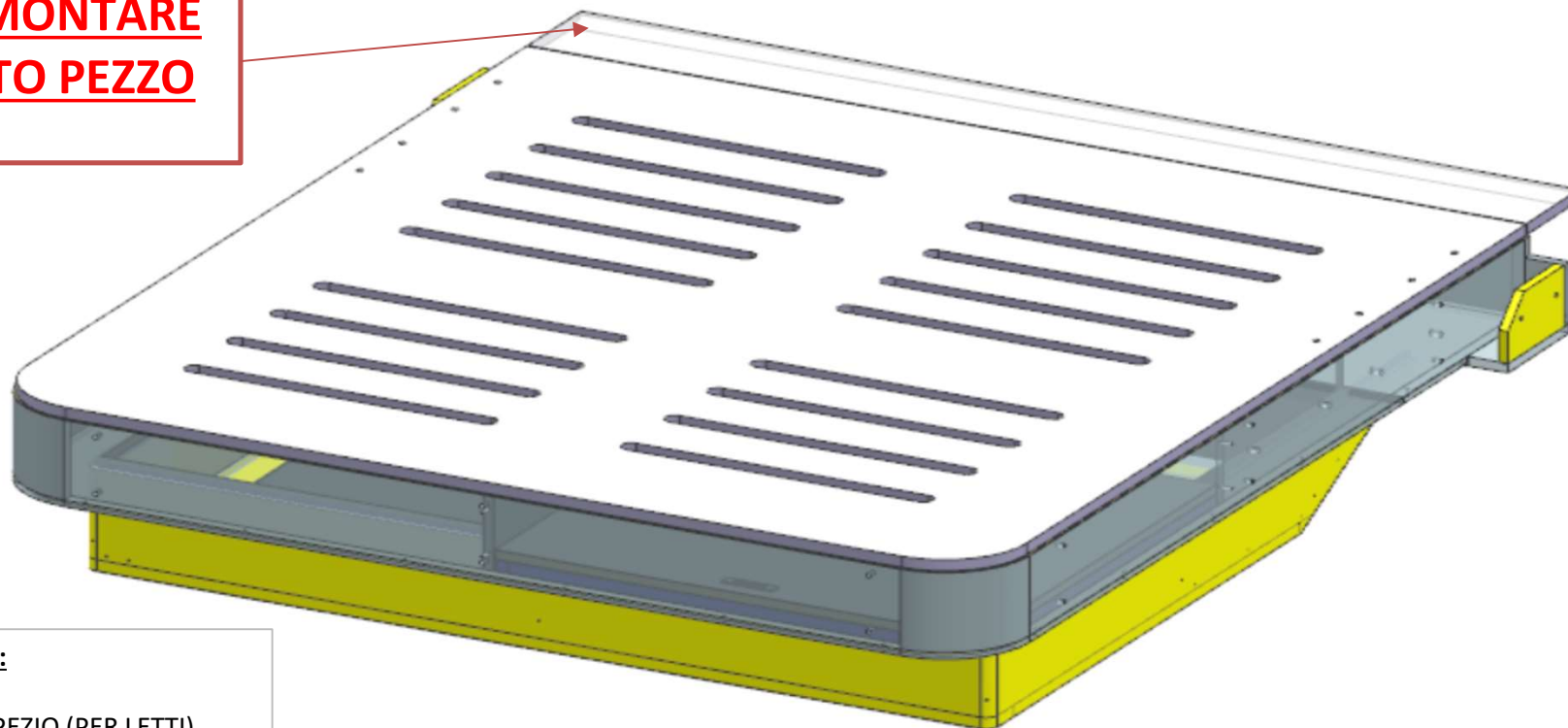

FERRAMENTA:

- N° 1 - KIT TRAPEZIO (PER LETTI)
- N° 2 - PISTONI GAS (letti)
- N° 4 - BUSSOLA ZAMA 6MA
- N° 1 - ALZAPAIOLO
- N° 23 - SPINE diam 8

AZ26M

MOD DA GR10

REV. GR 10

LOCALE	CODICE	DESCRIZIONE COMPONENTE	FINITURA	Q.TA	OPERATORE
CABINA OSPITI DX	AZ26M-MG_RG01	CIELINO			Damiano

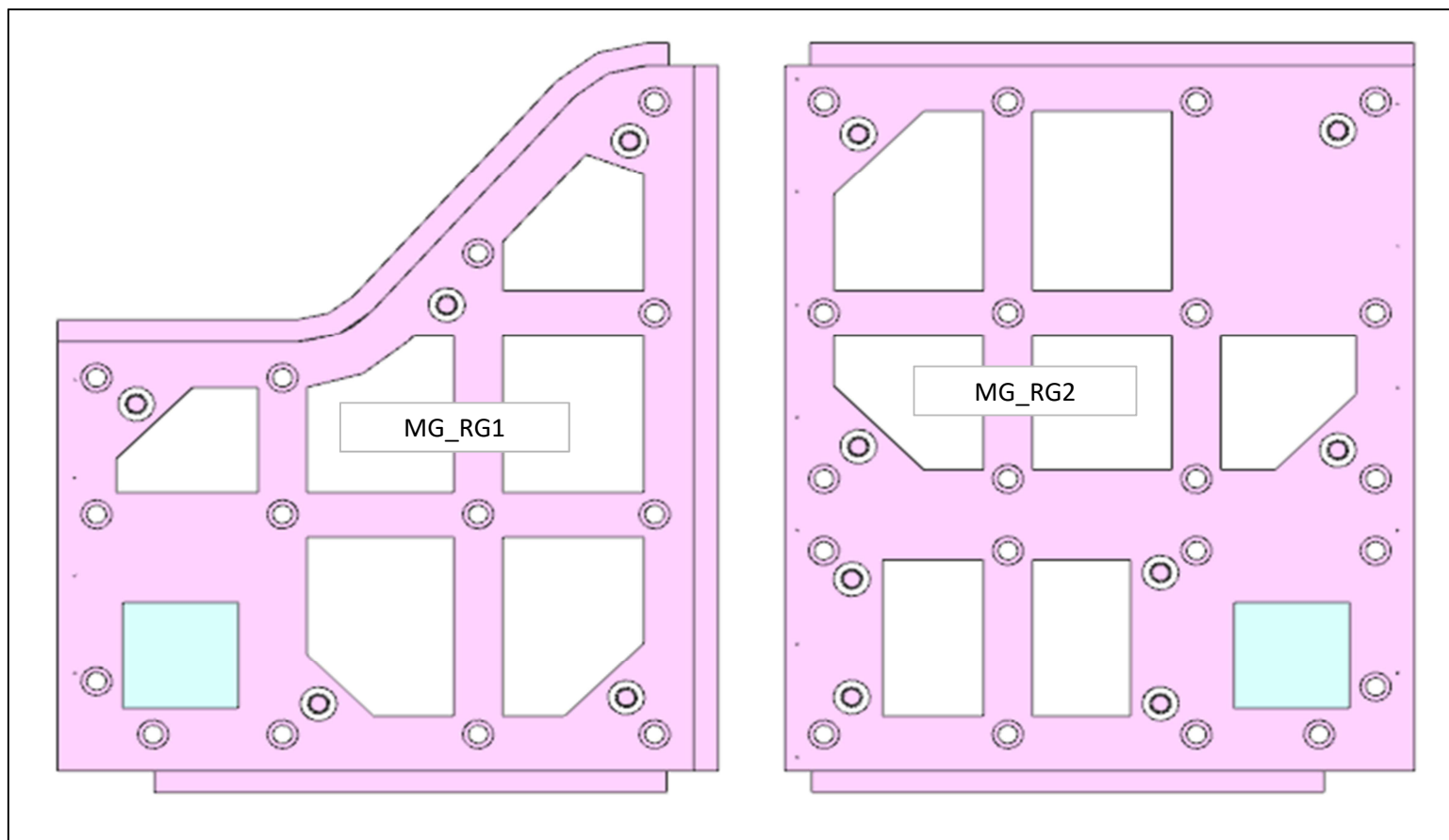

AZ26M

MOD GR4

REV. GR 9

LOCALE	CODICE	DESCRIZIONE COMPONENTE	FINITURA	Q.TA	OPERATORE
CABINA OSPITI DX	AZ26M-MG_RI01	CORNICE TV	LACCATO BRONZO	1	Damiano

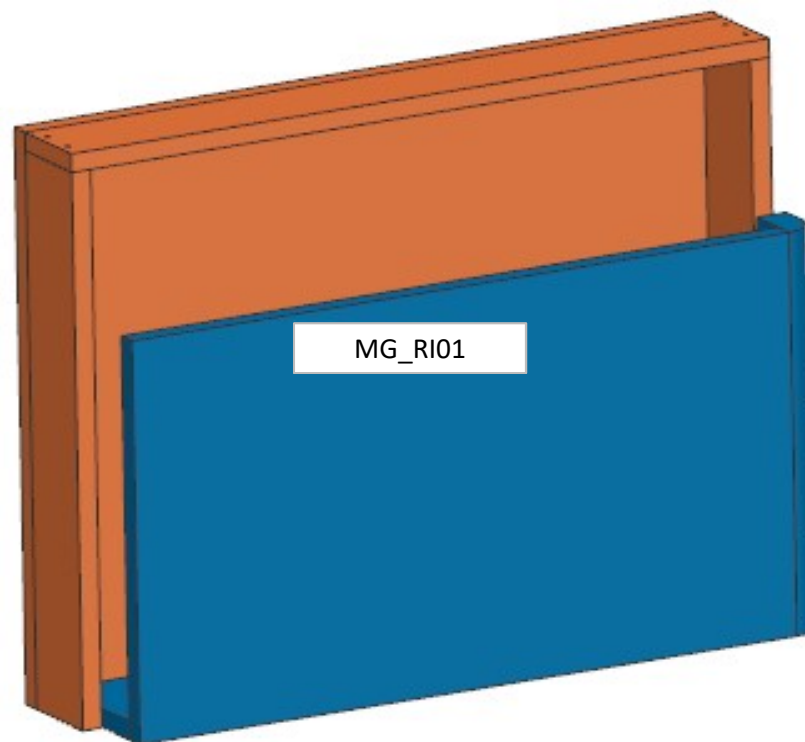

AZ26M

REV. GR 9

LOCALE	CODICE	DESCRIZIONE COMPONENTE	FINITURA	Q.TA	OPERATORE
CABINA OSPITI DX	AZ26M-MG_RQ01	PORTAGIOIE COMODINO POPPA-OPT			Damiano

VERSIONE CAPRI: BLU- NCS S4050-R70B 100 gloss

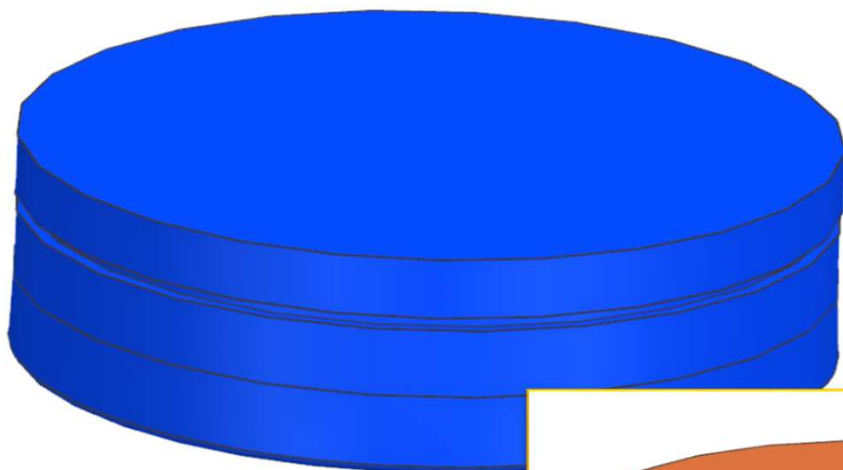

VERSIONE RIVIERA: BLU- NCS S4050-R70B 100 gloss

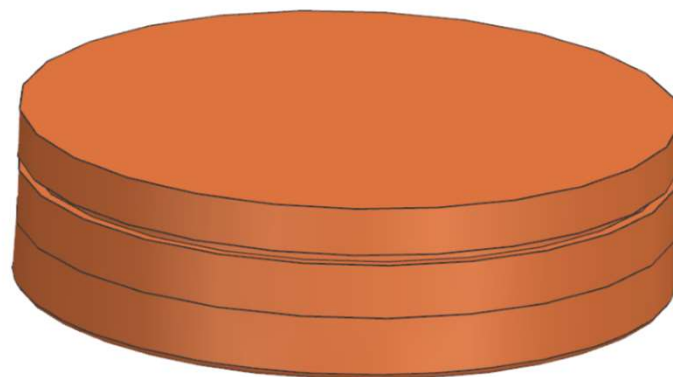
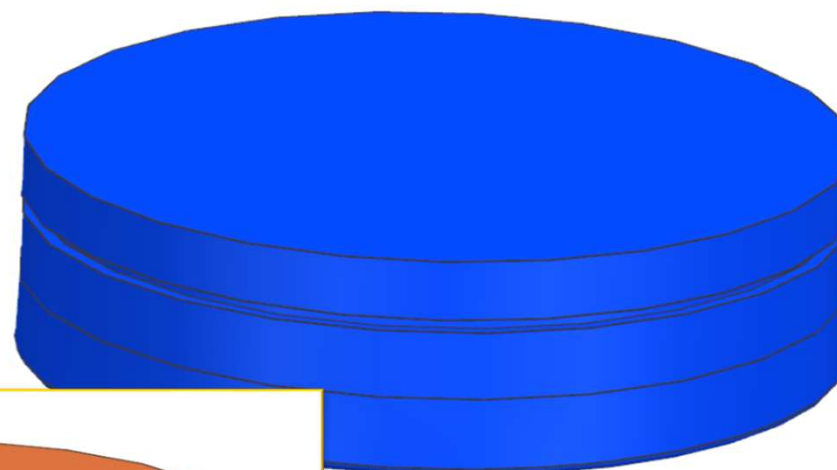

VERSIONE NEUTRA:
LACCATO BRONZO (DA

consonni&c

AZ26M

REV. GR 9

LOCALE	CODICE	DESCRIZIONE COMPONENTE	FINITURA	Q.TA	OPERATORE
CABINA OSPITI DX	AZ26M-MG_RP01	PORTAGIOIE COMODINO PRUA -OPT			Damiano

VERSIONE CAPRI: GIALLO- RAL 1004
100 gloss

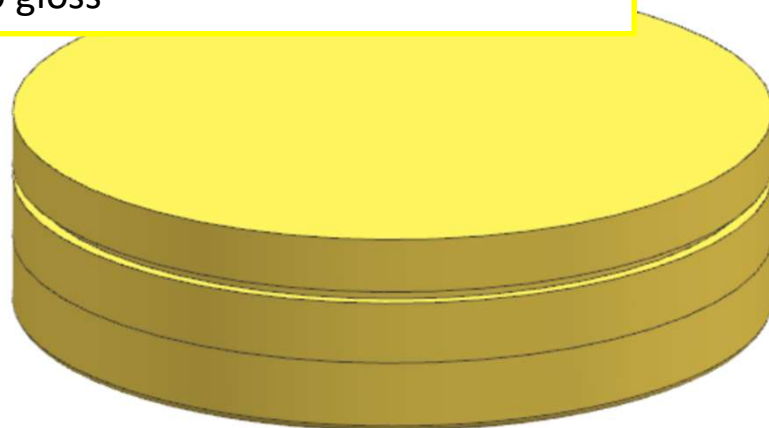

VERSIONE RIVIERA: ACQUAMARINA - NCS
S2030-B50G 100 gloss

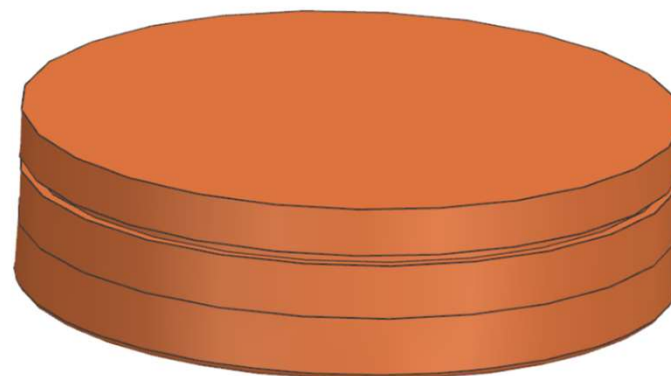
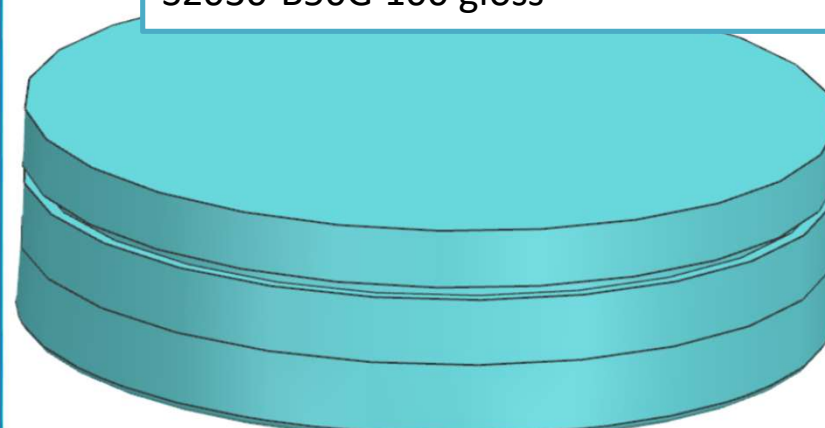

VERSIONE NEUTRA:
LACCATO BRONZO (DA

consonni&c

AZ26M

MOD GR4

REV. GR 9

LOCALE	CODICE	DESCRIZIONE COMPONENTE	FINITURA	Q.TA	OPERATORE
CABINA OSPITI DX	AZ26M-MG_RRC01	STRUTTURA LETTI STD-VAR 2 -SLIDING BAD			Dante

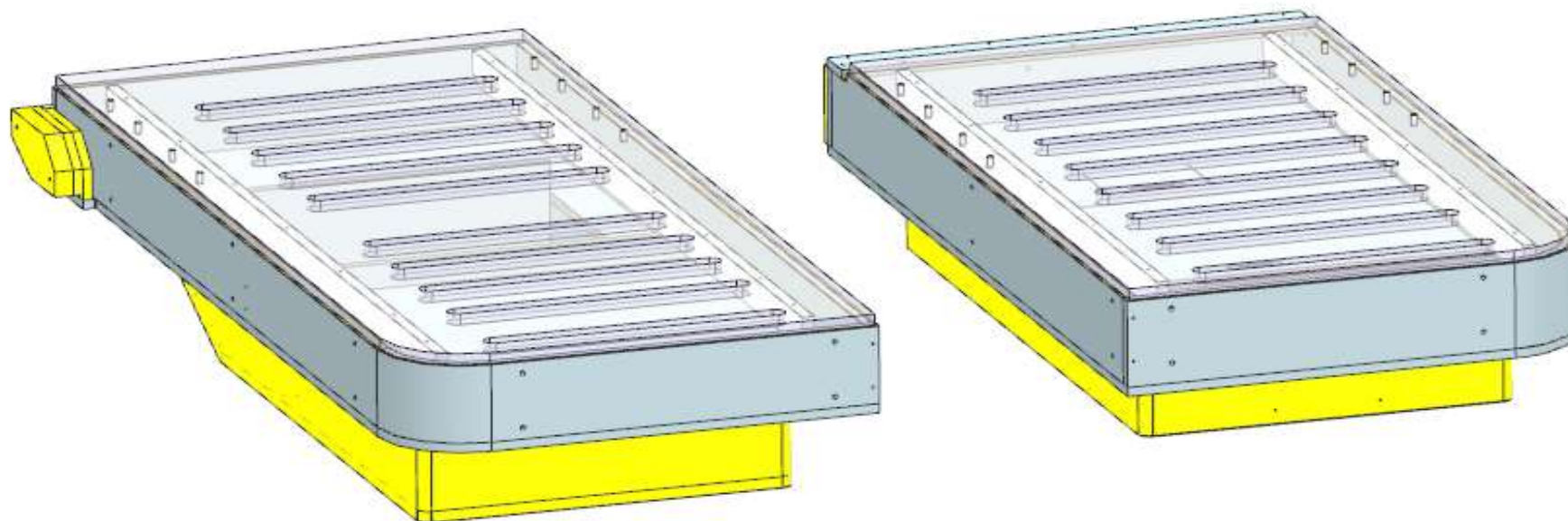

- MOD AZ 173**
- Inserita guida scorrevole a
 - inserite fasce per scorrimento ruote
 - inserite ruote
 - massimizzato lo storage del letto scorrevole

AZ26M

REV. GR 9

LOCALE	CODICE	DESCRIZIONE COMPONENTE	FINITURA	Q.TA	OPERATORE
CABINA OSPITI DX	AZ26M-MG_RRD01	COMODINO POPPA STD-VAR 2 -SLIDING BAD			Damiano

