

AZ26M

REV. 01-2023

REV. GR 9

LOCALE	CODICE	DESCRIZIONE COMPONENTE	FINITURA	Q.TA	OPERATORE
CABINA VIP SX	AZ26M-X01_VVA01	STRUTTURA MURATA TESTATA LETTO	LAMINATO NERO	2	Damiano

1 - 2 - L 40 x H.1160 x sp 3

1

2

ELEMENTO DA MONTARE con:
X01_VVA01
e spedire con un unico imballo

MOD AZ 216
RIMOSSI LAMINATI ALLA BASE

MF_VVA01

MF_VVA02

consonni&c

AZ26M

MOD GR4

REV. GR 9

LOCALE	CODICE	DESCRIZIONE COMPONENTE	FINITURA	Q.TA	OPERATORE
CABINA VIP SX	AZ26M-X01_VVB01	COMODINO PRUA	laminato bordeaux	1	Damiano

1 - L 329 x H 84,5 x sp 6

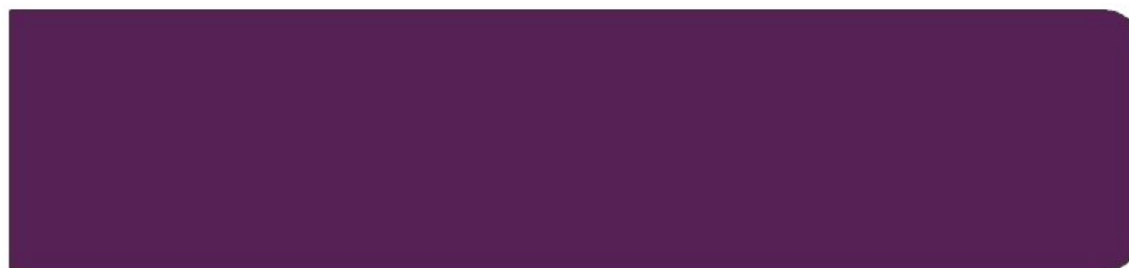

mod int 12
cambiato laccato
mogano in laminato
bordeaux

ELEMENTO DA MONTARE con:

L01_VVB01

L02_VVB01

L03_VVB01

VVB01

e spedire con un unico imballo

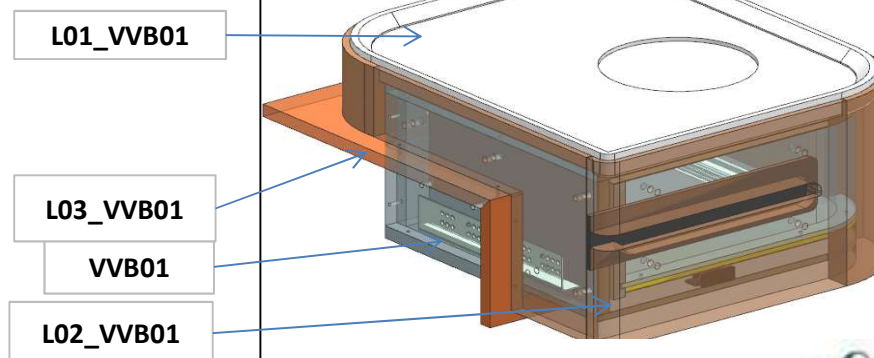

consonni&c

AZ26M

MOD GR4

REV. GR 9

LOCALE	CODICE	DESCRIZIONE COMPONENTE	FINITURA	Q.TA	OPERATORE
CABINA VIP SX	AZ26M--X01_VVD01	COMODINO POPPA	laminato bordeaux	1	Damiano

1 - L 311 x H 84,5 x sp 6



mod int 12
cambiato laccato
mogano in laminato
bordeaux

ELEMENTO DA MONTARE con:

L01_VVD01

L02_VVD01

L03_VVD01

VVD01

e spedire con un unico imballo

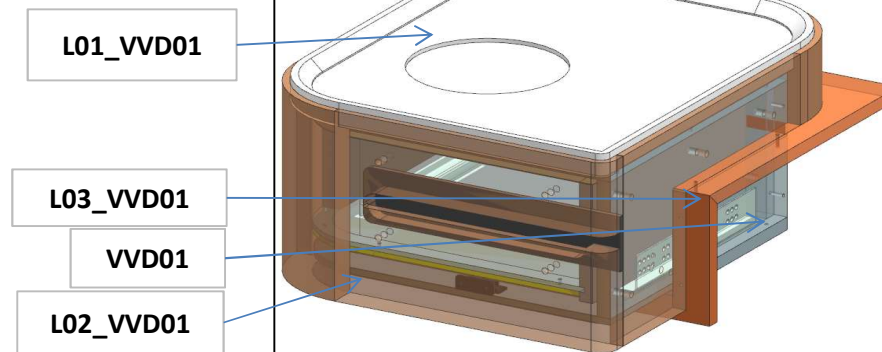

AZ26M

LOCALE	CODICE	DESCRIZIONE COMPONENTE	FINITURA	Q.TA	OPERATORE
CABINA VIP SX	AZ26M-X01_VVE01	RIVESTIMENTO PARETI PRUA	LAMINATO NERO	3	Damiano

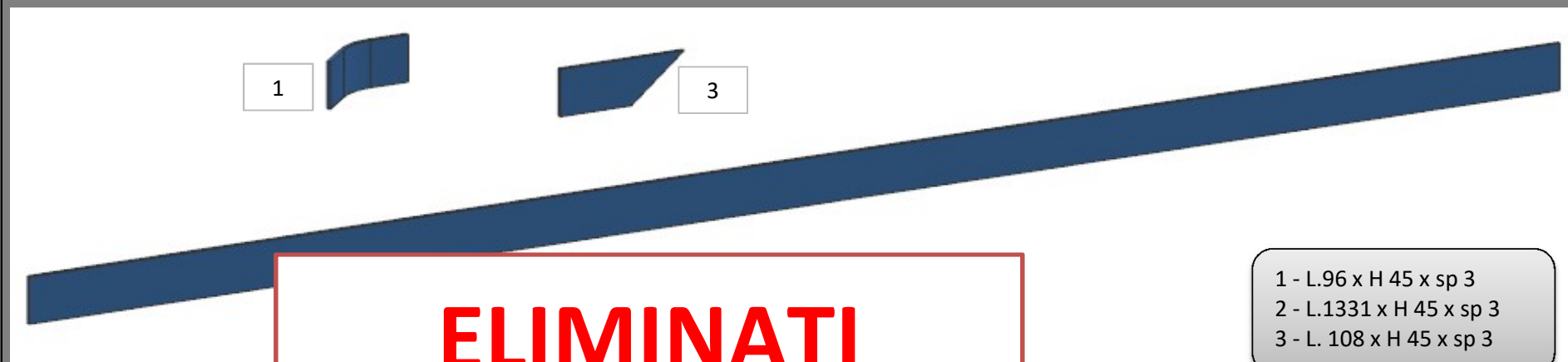

DETTAGLIO PZ. 1

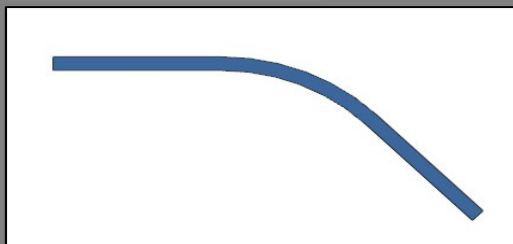

MF_VVE02

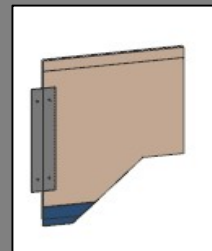

ELEMENTO DA MONTARE con:

R01_VVE01

L01_VVE01

e spedire con un unico imballo

MF_VVE01

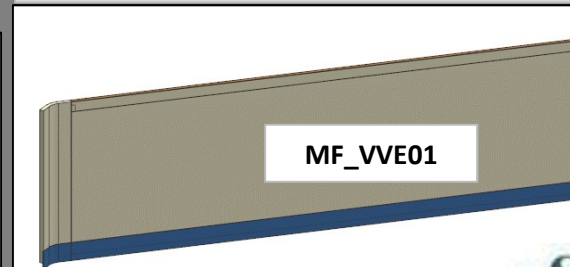

AZ26M

LOCALE	CODICE	DESCRIZIONE COMPONENTE	FINITURA	Q.TA	OPERATORE
CABINA VIP SX	AZ26M-X01_VVF01	RIVESTIMENTO PARETI POPPA	LAMINATO NERO	5	Damiano



DETTAGLIO CURVE IN PIANTA

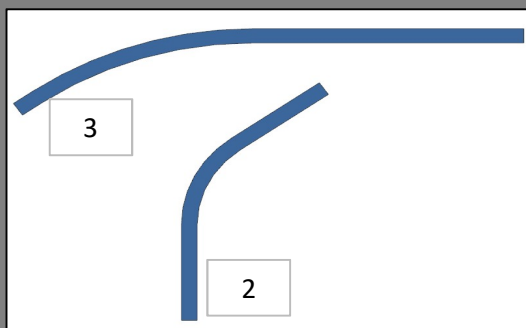

ELEMENTO DA MONTARE con:
R01_VVF01
L01_VVF01
e spedire con un unico imballo

R01_VVF01

L01_VVF01

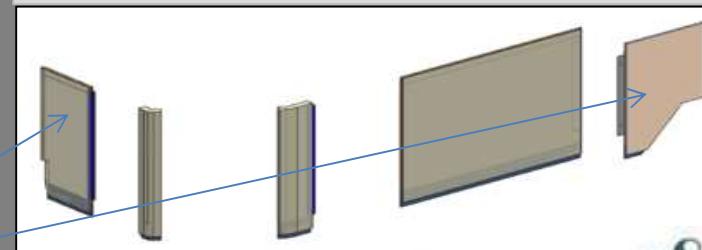

consonni&c

AZ26M

LOCALE	CODICE	DESCRIZIONE COMPONENTE	FINITURA	Q.TA	OPERATORE
CABINA VIP SX	AZ26M-X01_VVG01	RIVESTIMENTO PARETI CENTRO NAVE	LAMINATO NERO	4	Damiano

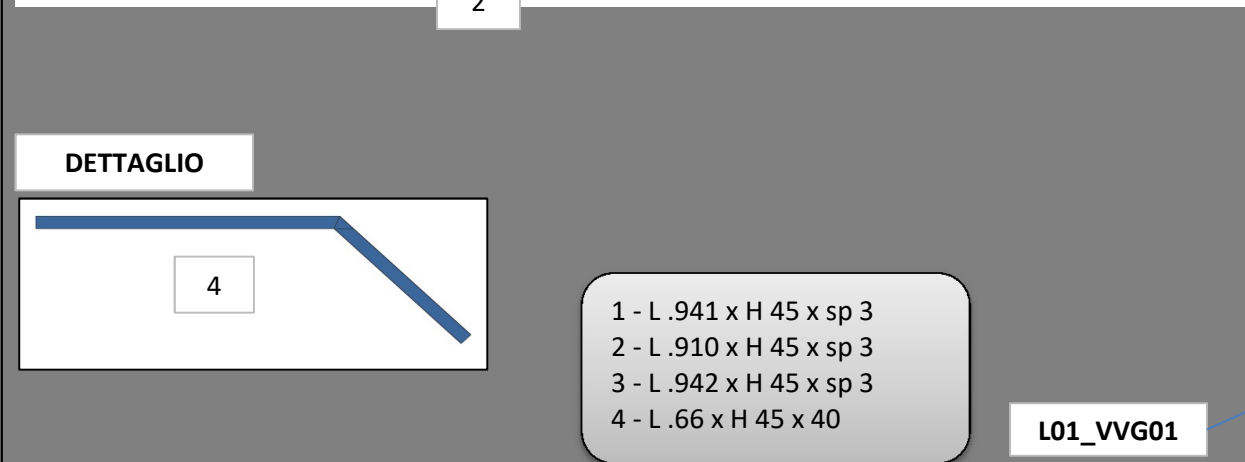

DETTAGLIO

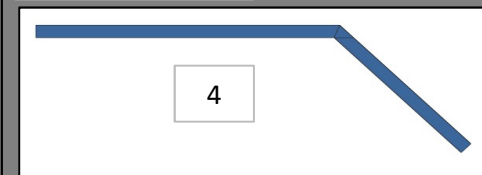

TO DA MONTARE con:
VVG01
L01_VVG01
 e spedire con un unico imballo

