

AZ26M

REV. 01-2023

REV. GR 9

LOCALE	CODICE	DESCRIZIONE COMPONENTE	FINITURA	Q.TA	OPERATORE
CABINA MARINAIO	AZ26M-L01_MF01	ARMADIO MARINAIO	LACCATO BIANCO 9016	3	Dante

- 1 - L.68 x H 1701 x 32
- 2 - L.409 x H 1002 x sp 16
- 3 - L.409 x H 696 x sp 16

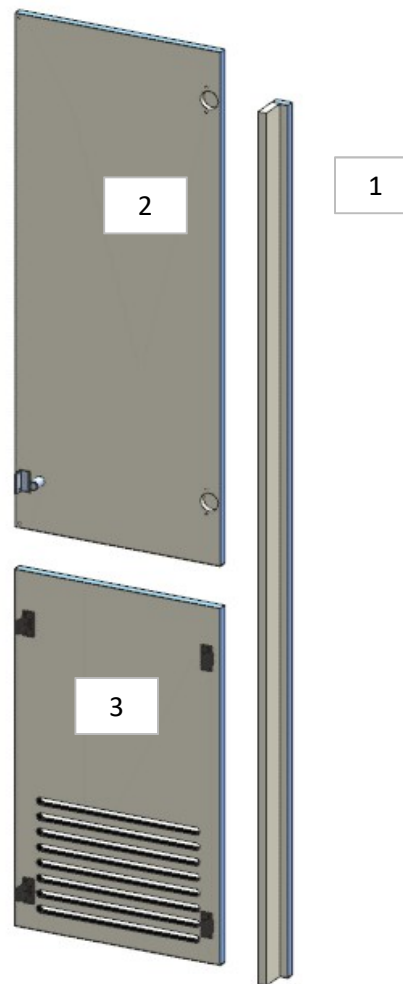

AZ26M

REV. 01-2023

REV. GR 9

LOCALE	CODICE	DESCRIZIONE COMPONENTE	FINITURA	Q.TA	OPERATORE
CABINA MARINAIO	AZ26M-L01_MG01	PLENUM MARINAIO	LACCATO BIANCO 9016	1	Dante

1 - L 443 x H.146 x sp 17

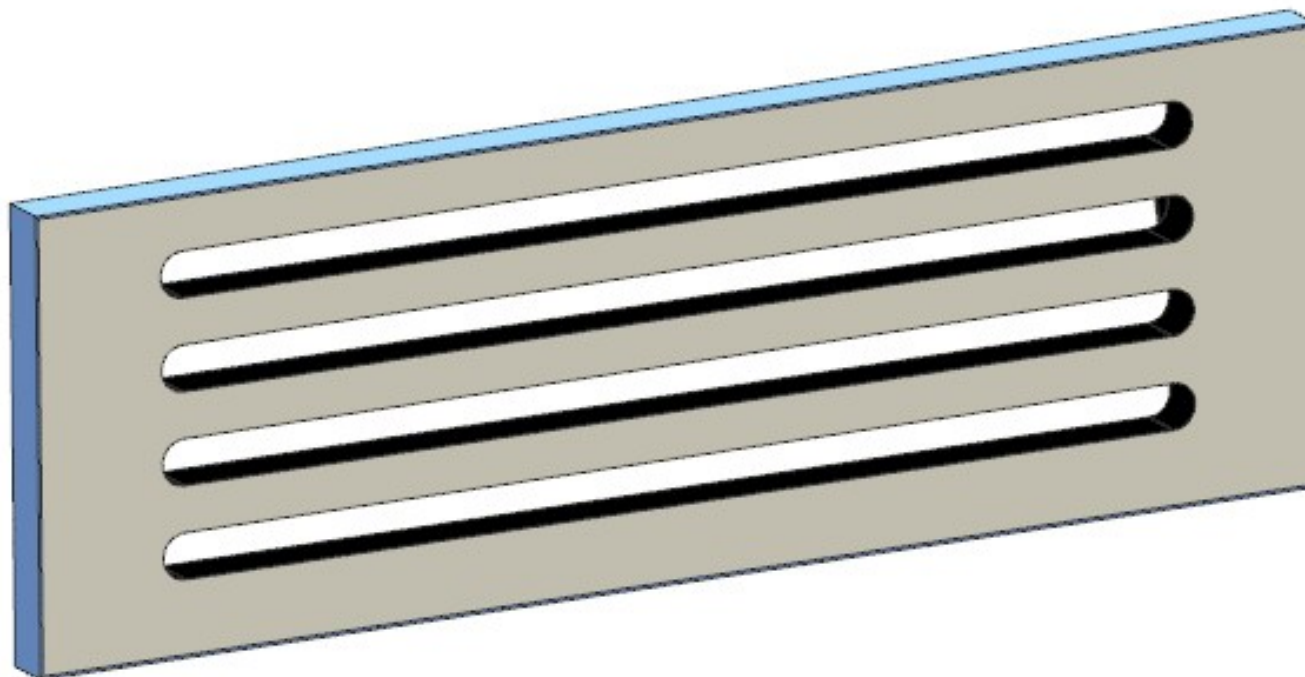

AZ26M

REV. GR 9

LOCALE	CODICE	DESCRIZIONE COMPONENTE	FINITURA	Q.TA	OPERATORE
CABINA MARINAIO	AZ26M-L01_ML01	PENSILE MURATA COMANDANTE	LACCATO BIANCO 9016	2	Dante

1 - 2 - L 477 x H.542 x sp 16

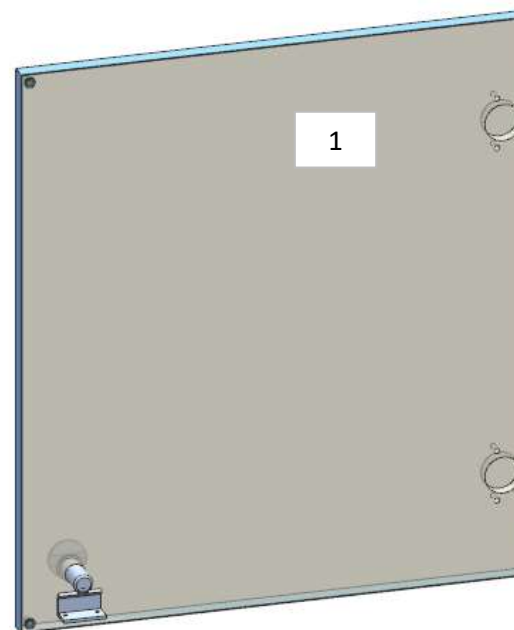
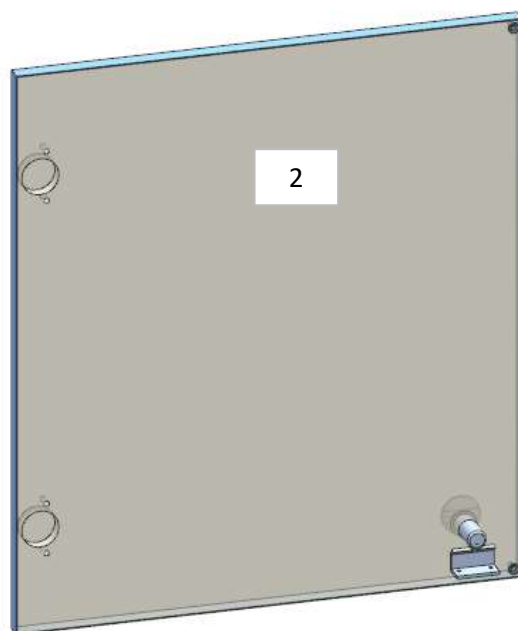

AZ26M

REV. 01-2023

REV. GR 9

LOCALE	CODICE	DESCRIZIONE COMPONENTE	FINITURA	Q.TA	OPERATORE
CABINA MARINAIO	AZ26M-L01_MN01	ARMADIO COMANDANTE	LACCATO BIANCO 9016	1	Dante

1 - L.435 x H.1319 x sp 16



AZ26M

REV. 01-2023

REV. GR 9

LOCALE	CODICE	DESCRIZIONE COMPONENTE	FINITURA	Q.TA	OPERATORE
CABINA MARINAIO	AZ26M-L01_MO01	PENSILE DINETTE	LACCATO BIANCO 9016	4	Dante

1 - 2 - 3 - 4 - L.364 x H.569 x sp 16

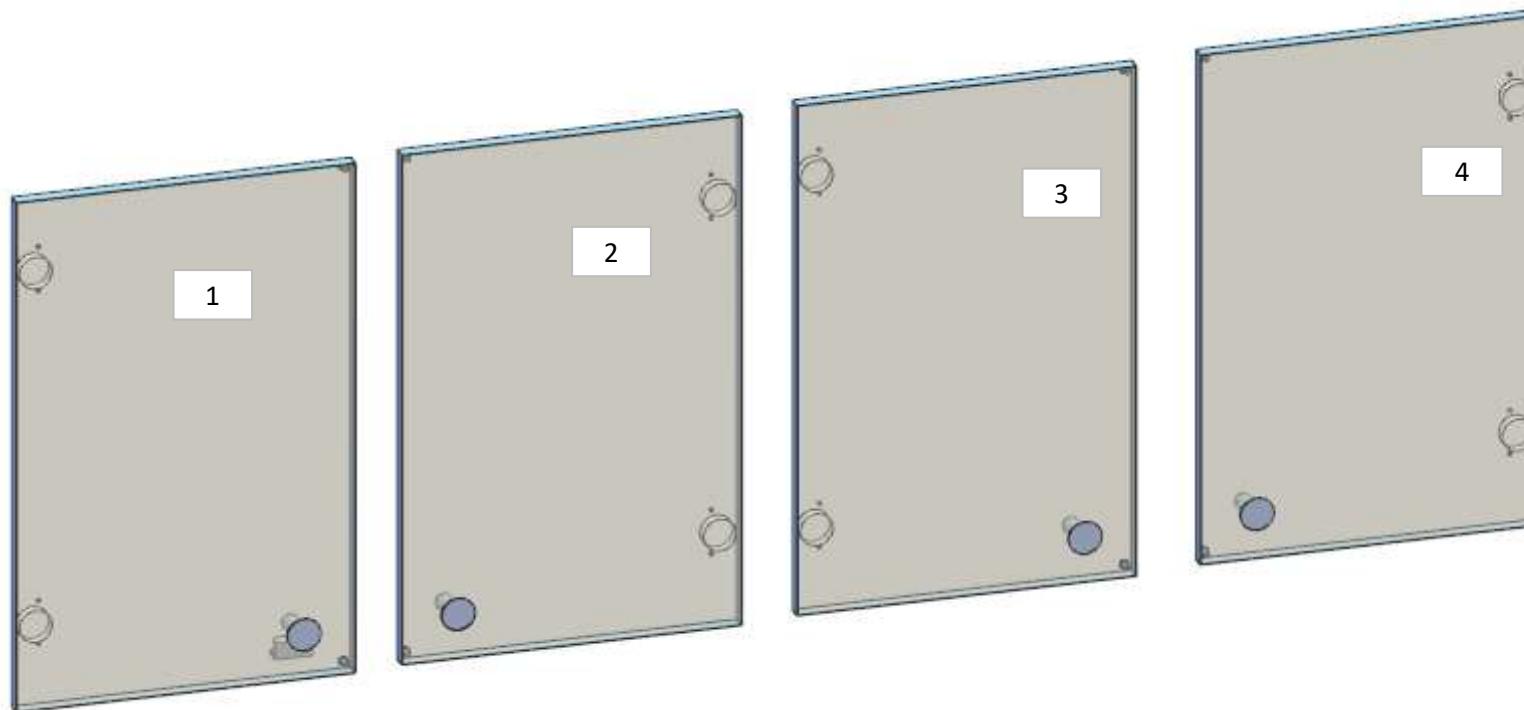

AZ26M

REV. 01-2023

REV. GR 9

LOCALE	CODICE	DESCRIZIONE COMPONENTE	FINITURA	Q.TA	OPERATORE
CABINA MARINAIO	AZ26M-L01_MS01	MOBILE LAVATRICE SX	LACCATO BIANCO 9016	1	Dante

1 - L.151 x H 911 x sp 16



AZ26M

REV. 01-2023

REV. GR 9

LOCALE	CODICE	DESCRIZIONE COMPONENTE	FINITURA	Q.TA	OPERATORE
CABINA MARINAIO	AZ26M-L01_MT01	MOBILE LAVATRICE DX	LACCATO BIANCO 9016	1	Dante

1 - L.151 x H 911 x sp 16



AZ26M

REV. 01-2023

REV. GR 9

LOCALE	CODICE	DESCRIZIONE COMPONENTE	FINITURA	Q.TA	OPERATORE
CABINA MARINAIO	AZ26M-L01_MU01	PENSILE LAVATRICE SX	LACCATO BIANCO 9016	1	Dante

1 - L.782 x H 322 x sp 16

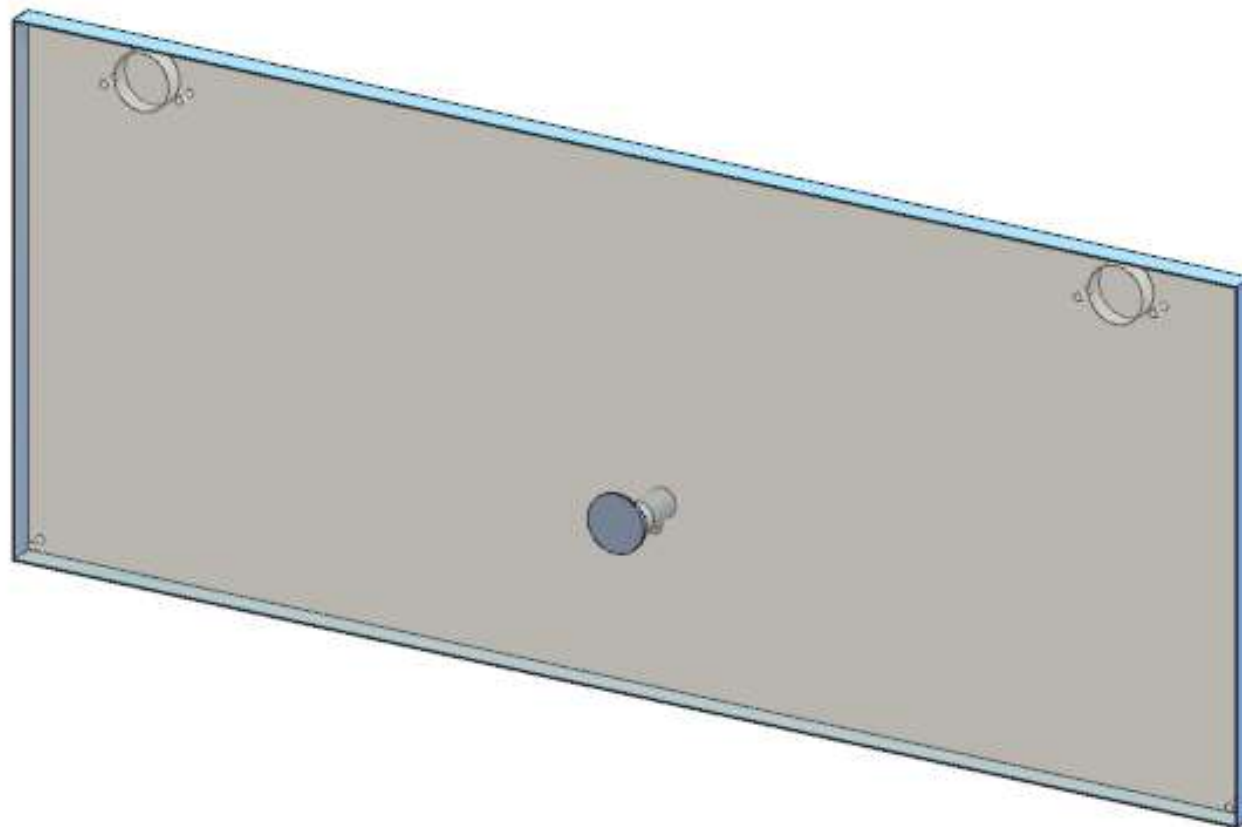

AZ26M

REV. 01-2023

REV. GR 9

LOCALE	CODICE	DESCRIZIONE COMPONENTE	FINITURA	Q.TA	OPERATORE
CABINA MARINAIO	AZ26M-L01_MV01	PENSILE LAVATRICE DX	LACCATO BIANCO 9016	1	Dante

1 - L.782 x H.322 x sp 16

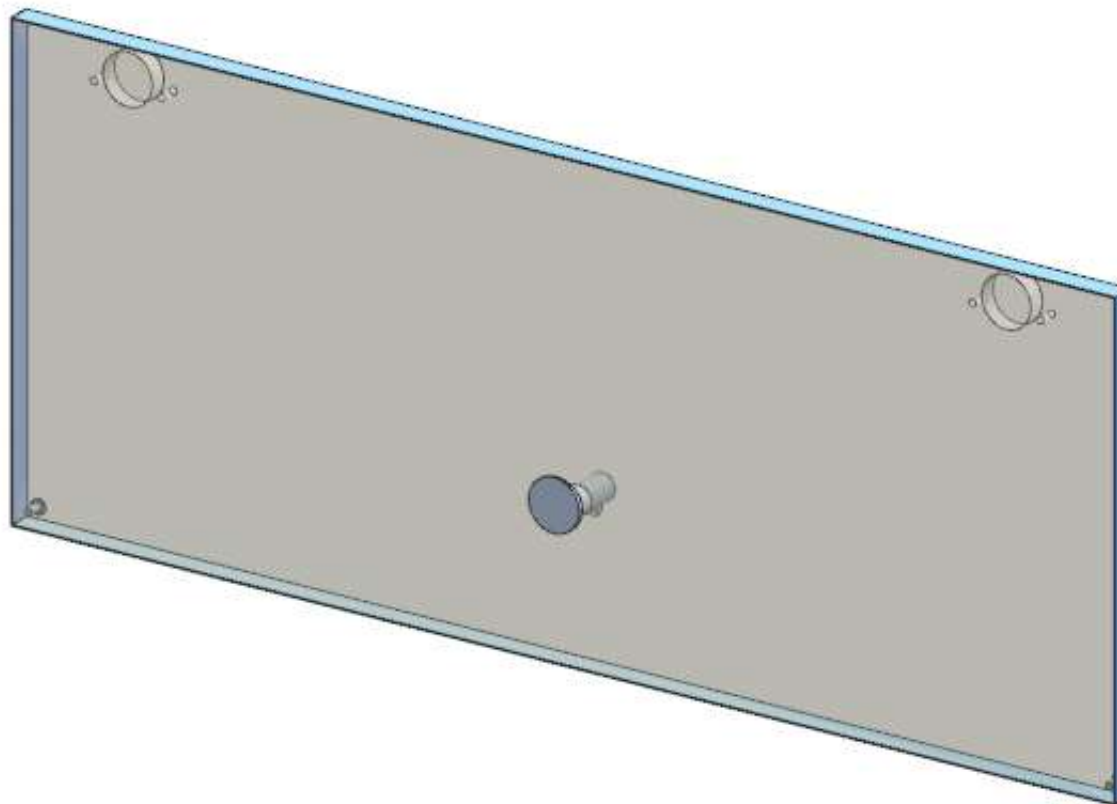

AZ26M

REV. 01-2023

REV. GR 9

LOCALE	CODICE	DESCRIZIONE COMPONENTE	FINITURA	Q.TA	OPERATORE
CABINA MARINAIO	AZ26M-L01_MY01	MOBILE LAVATRICE DX OPT	LACCATO BIANCO 9016	2	Dante

1 - 2 - L.315 x H 911 x sp 16

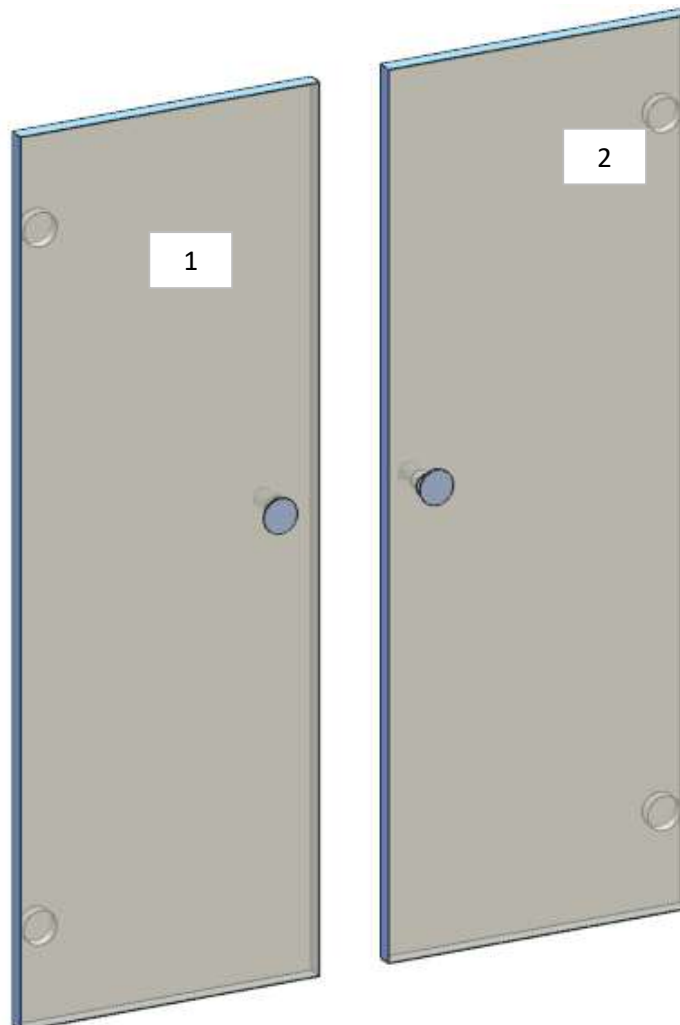

AZ26M

REV. GR 9

LOCALE	CODICE	DESCRIZIONE COMPONENTE	FINITURA	Q.TA	OPERATORE
CABINA MARINAIO	AZ26M-L01_MMG01	CIELINO DINETTE SX	LACCATO BIANCO 9016	2	Damiano

- 1 - L.924 x H.466 x sp 16
- 2 - L 1651 x H 701 x sp 16

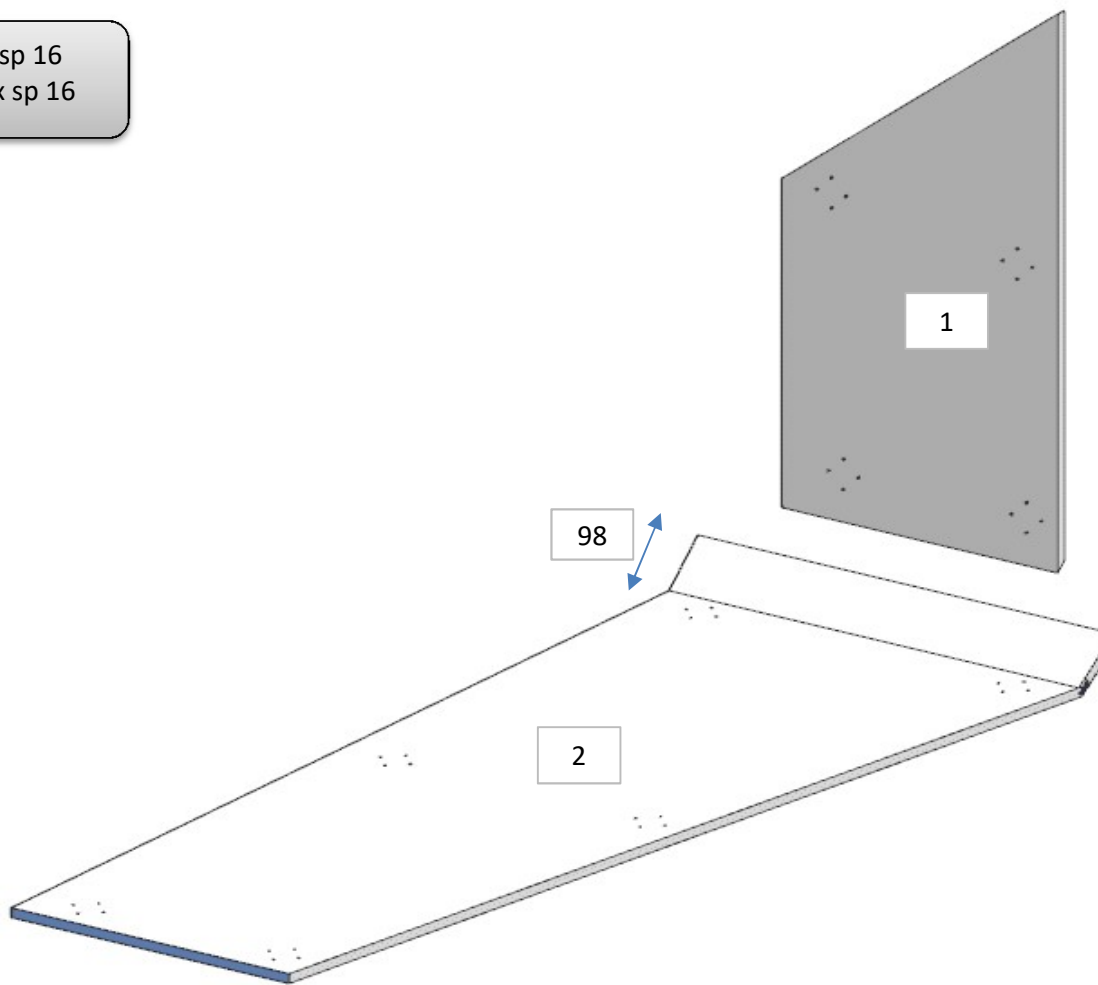

AZ26M

REV. GR 9

LOCALE	CODICE	DESCRIZIONE COMPONENTE	FINITURA	Q.TA	OPERATORE
CABINA MARINAIO	AZ26M-L01_MMH01	CIELINO ALZATA DINETTE SX	LACCATO BIANCO 9016	1	Damiano

1 - L 1645 x H 395 x sp 16

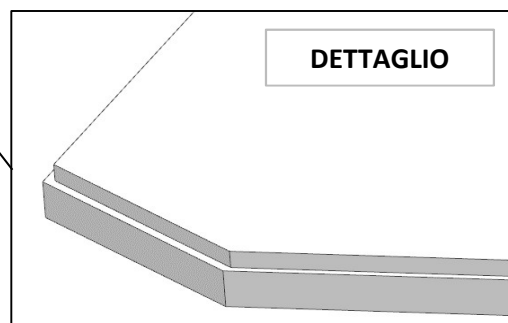
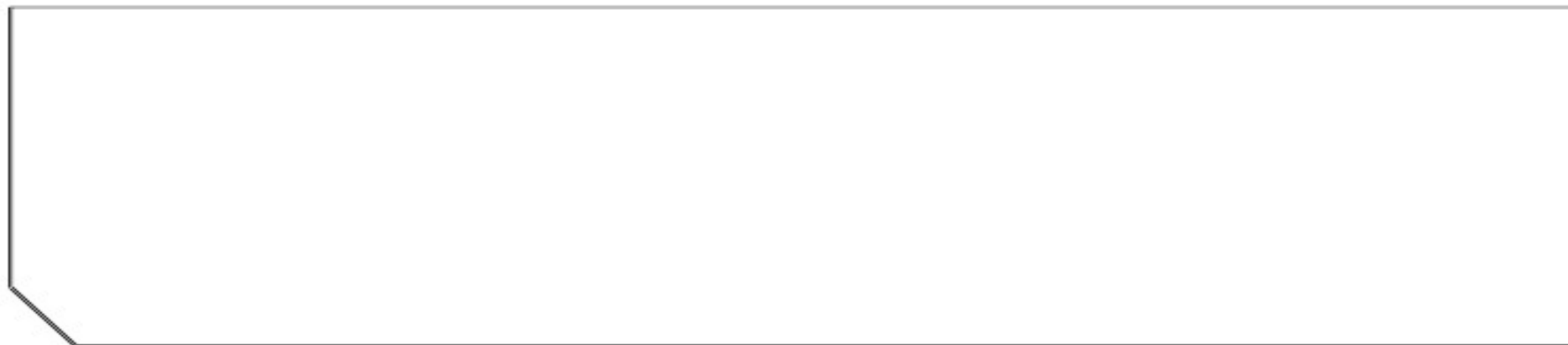

AZ26M

REV. GR 9

LOCALE	CODICE	DESCRIZIONE COMPONENTE	FINITURA	Q.TA	OPERATORE
CABINA MARINAIO	AZ26M-L01_MMI01	CIELINO ALZATA DINETTE DX	LACCATO BIANCO 9016	2	Damiano

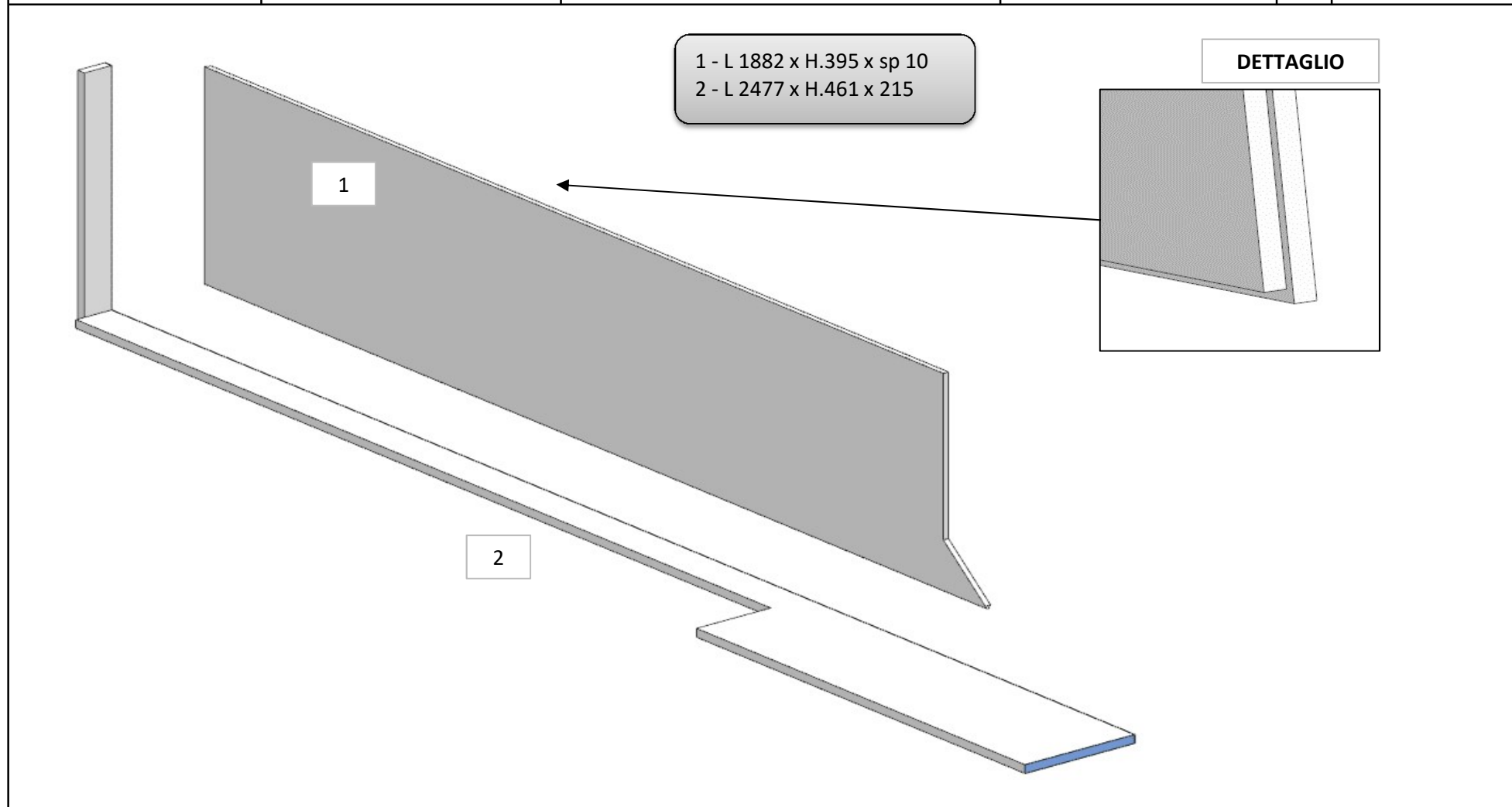

AZ26M

REV. GR 9

LOCALE	CODICE	DESCRIZIONE COMPONENTE	FINITURA	Q.TA	OPERATORE
CABINA MARINAIO	AZ26M-L01_MMM01	CIELINO BAGNO MARINAIO	LACCATO BIANCO 9016	1	Damiano

1 - L.741 x H 526 x sp 10

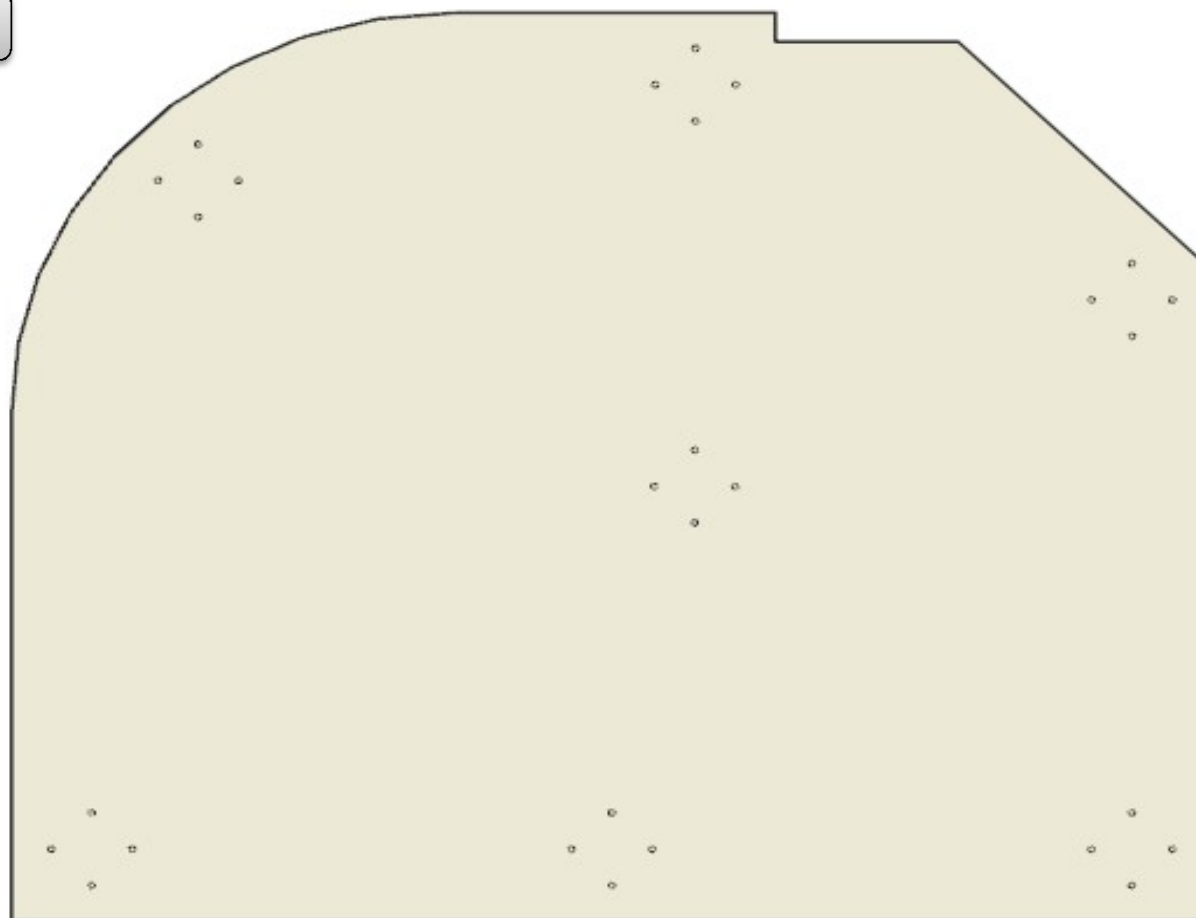

AZ26M

REV. 01-2023

REV. GR 9

LOCALE	CODICE	DESCRIZIONE COMPONENTE	FINITURA	Q.TA	OPERATORE
CABINA MARINAIO	AZ26M-L01_MMN01	MOBILE LAVELLO BAGNO MARINAIO	LACCATO BIANCO 9016	2	Damiano

1 - 2 - L.232 x H.397 x sp 16

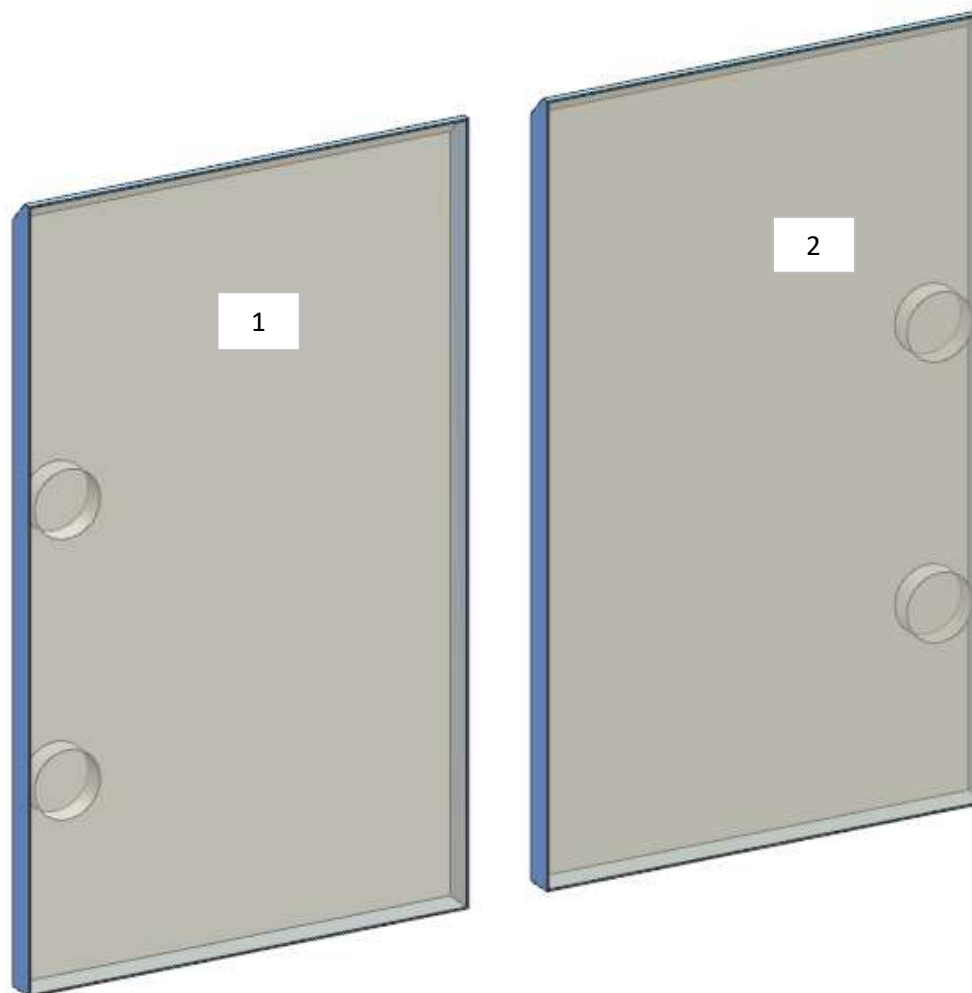

AZ26M

REV. GR 9

LOCALE	CODICE	DESCRIZIONE COMPONENTE	FINITURA	Q.TA	OPERATORE
CABINA MARINAIO	AZ26M-L01_MMZ01	ANTE OPT ARMADIO CAMBUSA	LACCATO BIANCO RAL 9016	5	Damiano

1 - 2 - L 438 x H.348 x sp 16
3 - 4 - L 438 x H.765 x sp 16

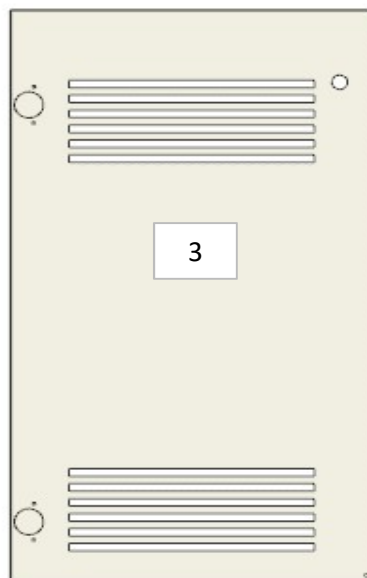

AZ26M

REV. GR 9

LOCALE	CODICE	DESCRIZIONE COMPONENTE	FINITURA	Q.TA	OPERATORE
CABINA MARINAIO	AZ26M-L01_MMZ02	ARMADIO CAMBUSA	LACCATO BIANCO 9016	2	Dante

1 - 2 - L 438 x H.1391 x sp 16

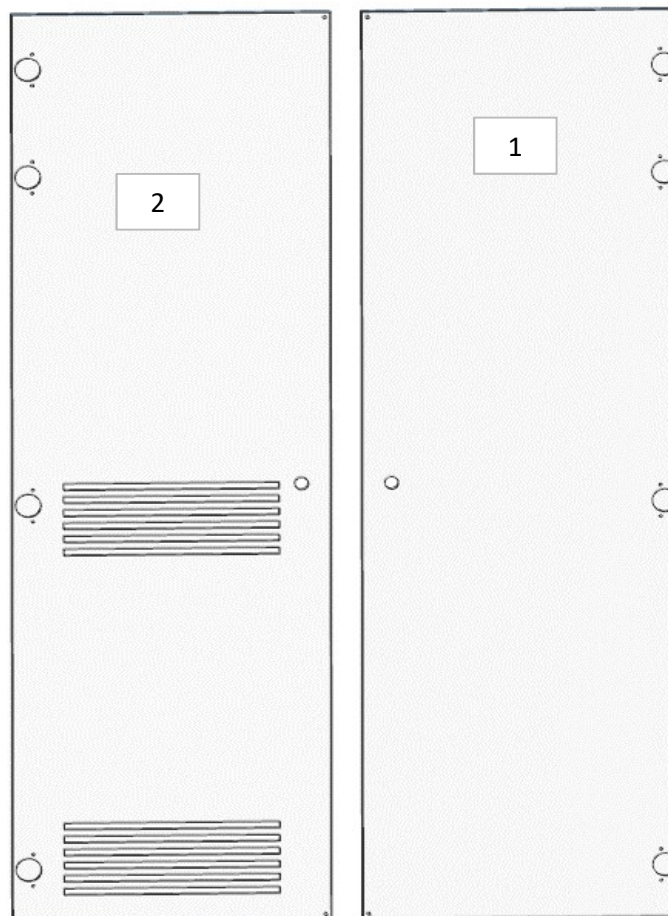

AZ26M

REV. GR 9

LOCALE	CODICE	DESCRIZIONE COMPONENTE	FINITURA	Q.TA	OPERATORE
CABINA MARINAIO	AZ26M-L01_MMX01	MENSOLA A RIBALTA COMANDANTE OPT	LACCATO BIANCO RAL 9016	1	Damiano

1 - L 430 x H.340 x sp 16

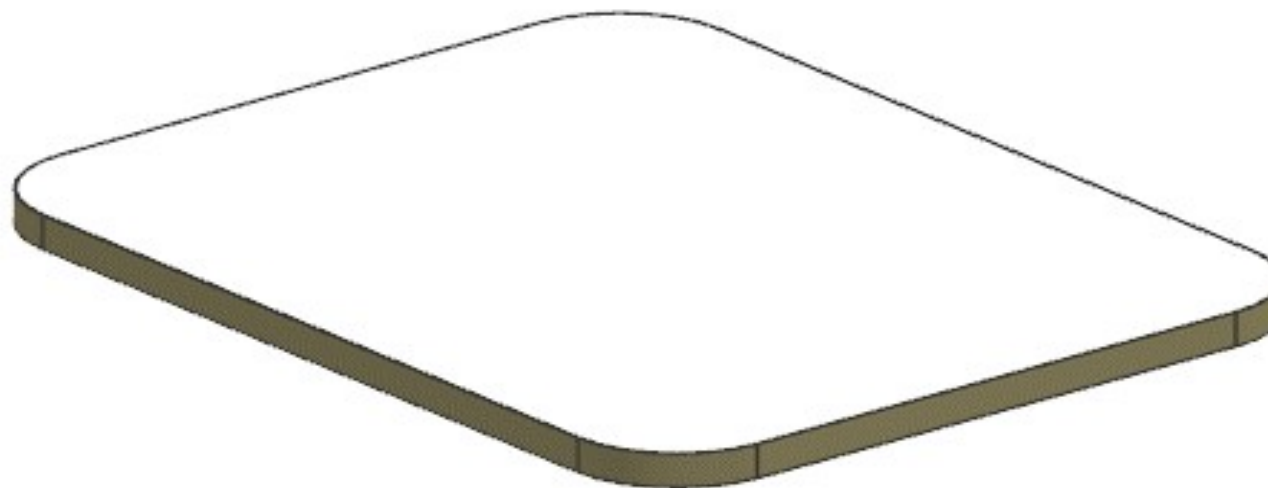

FERRAMENTA:

N° 2 - MECCANISMO A RIBALTA SUGATSUNE