

AZ26M

REV. GR 10

LOCALE	CODICE	DESCRIZIONE COMPONENTE	FINITURA	Q.TA	OPERATORE
CABINA ARMATORE	AZ26M-S01_AF01	CORNICE TV - STOPSOL 55 - VAR 1	SPECCHIO STOPSOL 5 mm RETROV. da 55"	2	Damiano

STOP SOL RETROVERNICIATURA PER
55 POLLICI

1 - L 1415 x H.1290 x sp 5
2 - L 1415 x H.609 x sp 5

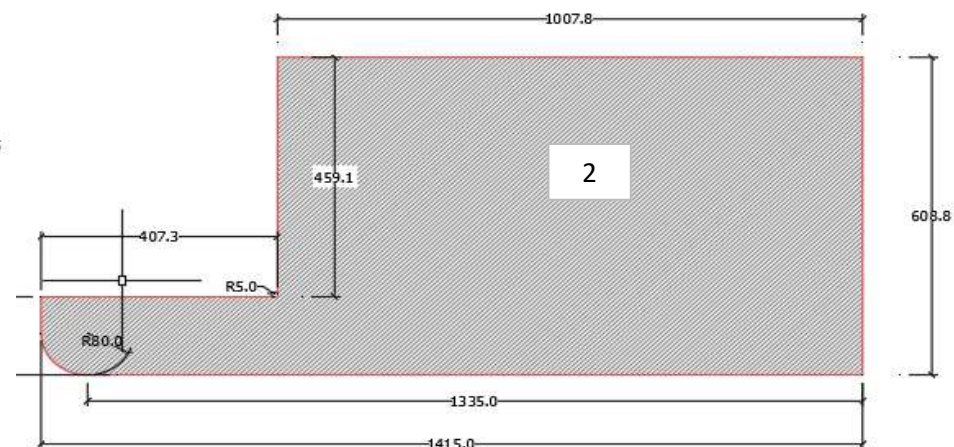
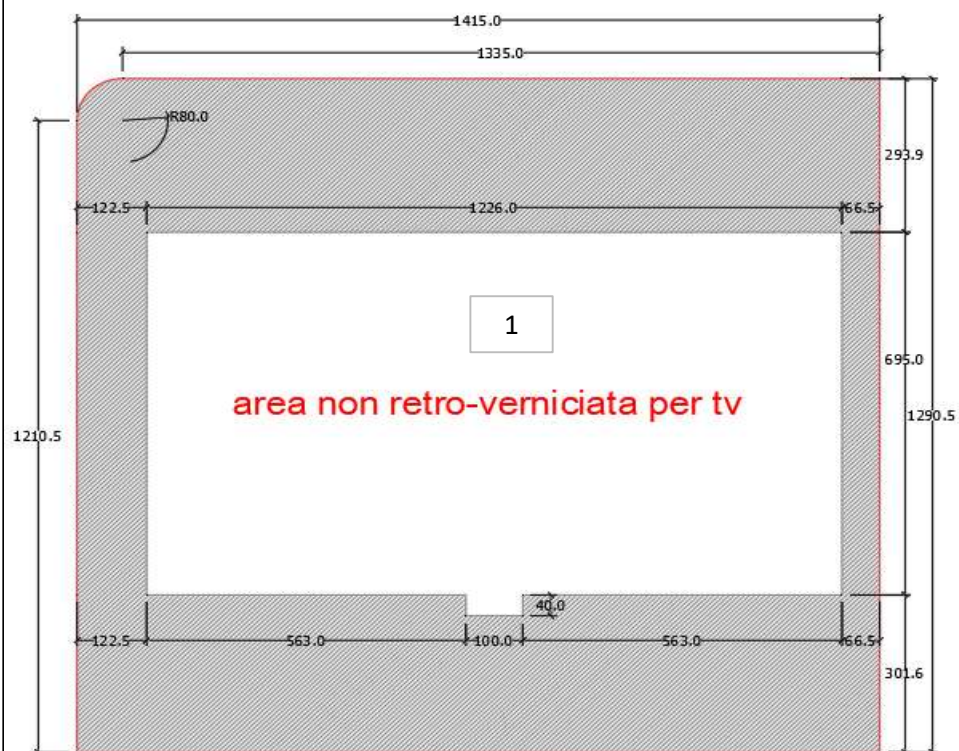

AZ26M

REV. GR 10

LOCALE	CODICE	DESCRIZIONE COMPONENTE	FINITURA	Q.TA	OPERATORE
CABINA ARMATORE	AZ26M-S01_AF02	CORNICE TV - STOPSOL 43 - VAR 2	SPECCHIO STOPSOL 5 mm RETROV. da 43"	2	Damiano

**STOP SOL RETROVERNICIATURA PER 43
POLLCI**

1 - L 1415 x H.1290 x sp 5
2 - L 1415 x H.609 x sp 5



1
area non retro-verniciata per tv

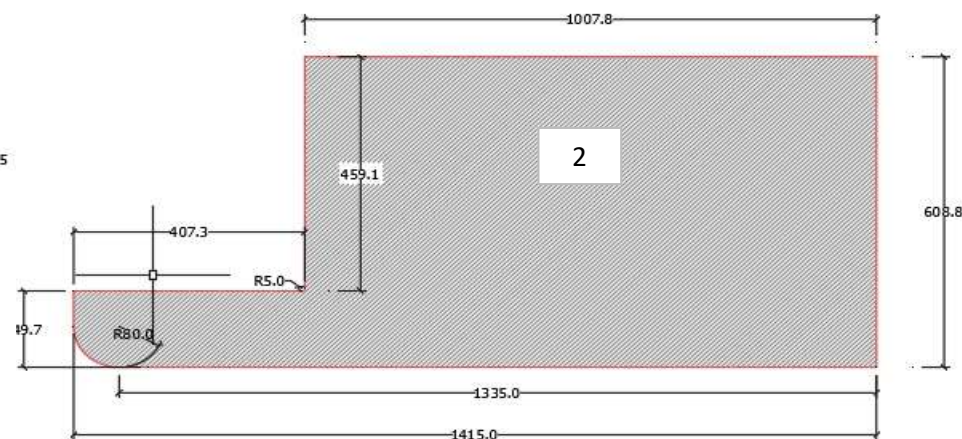

AZ26M

REV. 01-2023

REV. GR 9

LOCALE	CODICE	DESCRIZIONE COMPONENTE	FINITURA	Q.TA	OPERATORE
CABINA ARMATORE	AZ26M-AQ01	ARMADIO DRESSING PRUA CENTRONAVE STD-VAR1	LAMINATO NADIR	4	Damiano

2 - L. 455 x H 970 x sp 16
3 - L. 658 x H 378 x 66
4 - L. 364 x H 402 x sp 16

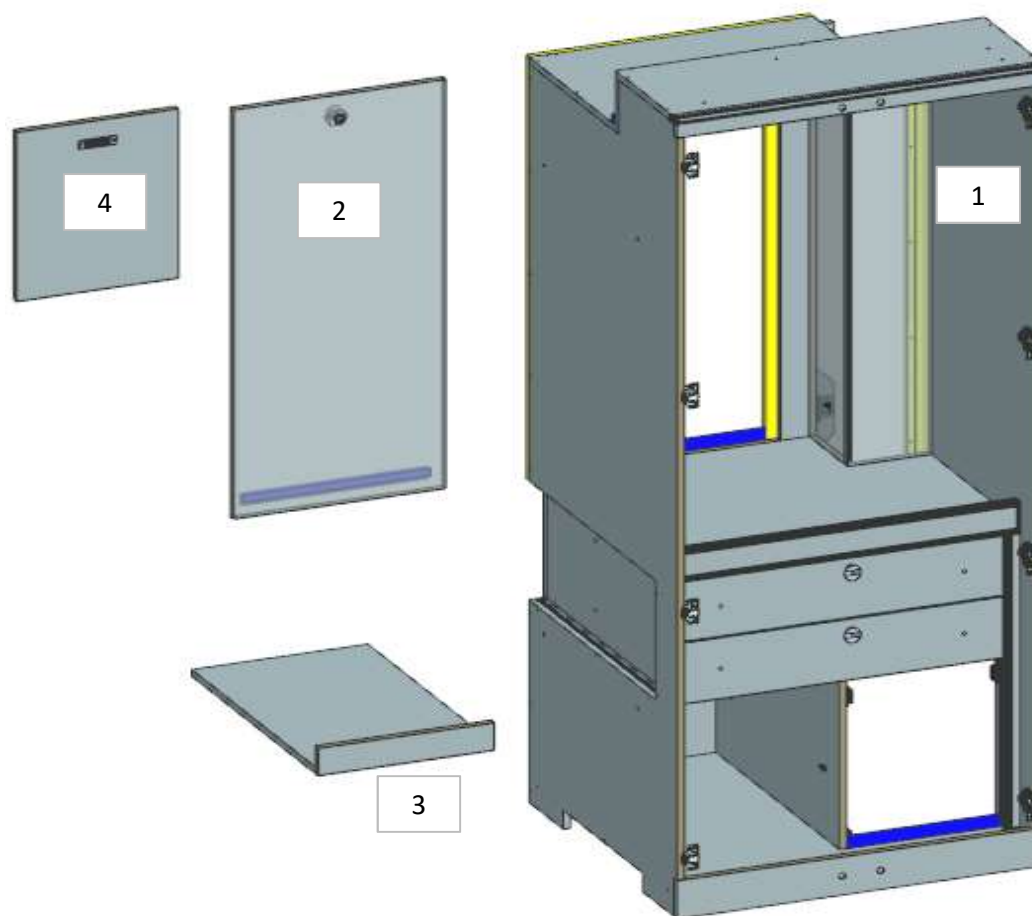

FERRAMENTA:

N° 8 - CERNIERA PIANA BLUMOTION 95°
N° 8 - Basetta H3
N° 32 - ANKOR BORGHI
N° 32 - VITI 4MA X 8
N° 4- SOUTCHO
N° 1 - ALZA PAIOLO
N° 8 - CALAMITA A INCASSO diam 15
N° 2- GUIDE 400
N° 4- CALAMITE PER CASSETTI
N° 4- REGGIRIPIANO 1 PERNO 1 FORO
N° 10 - BUSSOLA ZAMA 6MA
N° 10 - SPINA diam 8
N° 4 - VITI 6MA
N° 1 - KIT MINI PUSH

AZ26M

REV. 01-2023

REV. GR 9

LOCALE	CODICE	DESCRIZIONE COMPONENTE	FINITURA	Q.TA	OPERATORE
CABINA ARMATORE	AZ26M-MG_AQ01	ARMADIO DRESSING PRUA CENTRONAVE STD-VAR1			Damiano

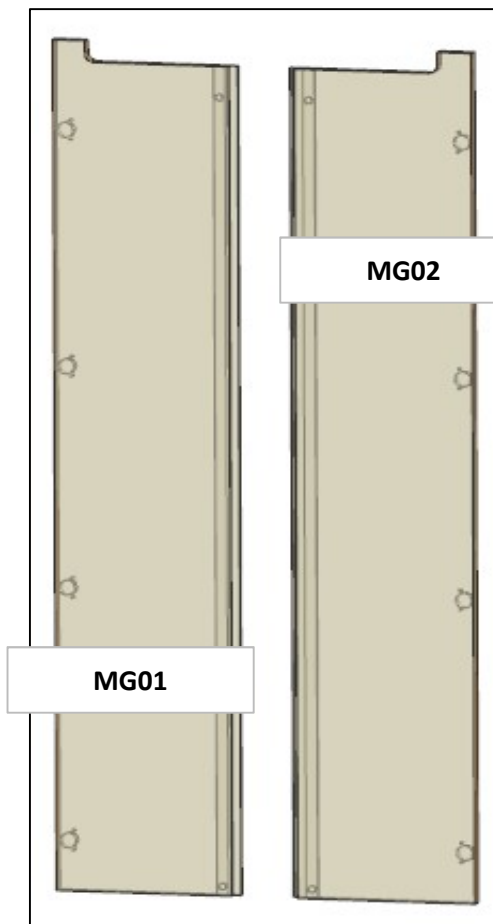

AZ26M

REV. 01-2023

REV. GR 9

LOCALE	CODICE	DESCRIZIONE COMPONENTE	FINITURA	Q.TA	OPERATORE
CABINA ARMATORE	AZ26M-R01_AQ01	ARMADIO DRESSING PRUA CENTRONAVE STD-VAR1	LASTRA CHIARA	2	Damiano

1 - 2 - L 380 x H 1968 x sp 25
3 - 4 - L 53 x H 1918 x sp 6

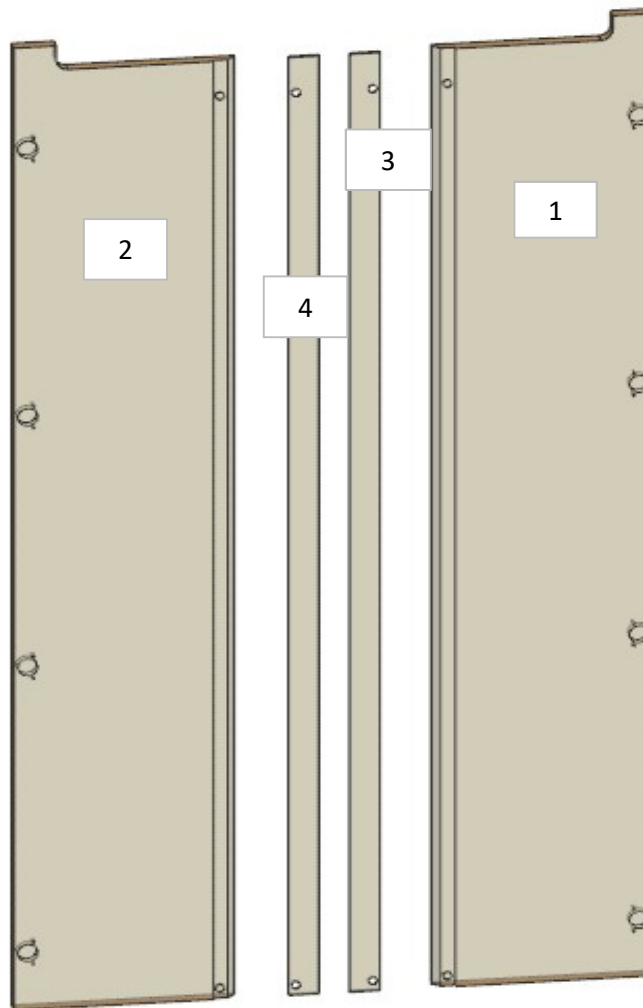

**ELEMENTO DA
MONTARE:
MG01
MG02**
e spedire con un unico
imballo

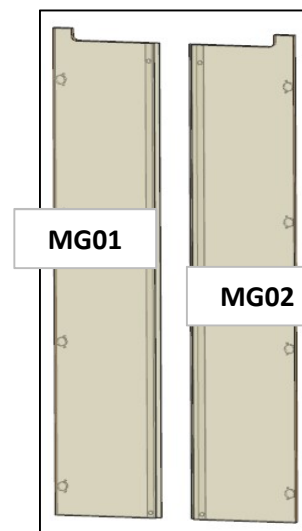

DETTAGLIO

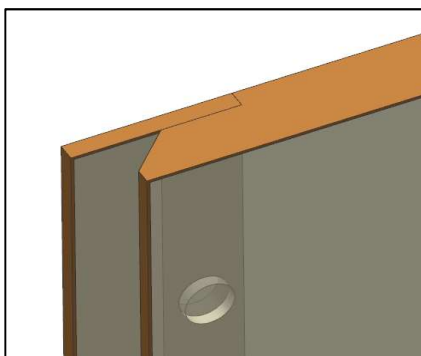

consonni&c

AZ26M

REV. GR 9

LOCALE	CODICE	DESCRIZIONE COMPONENTE	FINITURA	Q.TA	OPERATORE
CABINA ARMATORE	AZ26M-AR01	PLENUM ARMADIO PRUA STD-VAR1	GREZZO VERNICIATO ANTI ROMBO	1	Dante

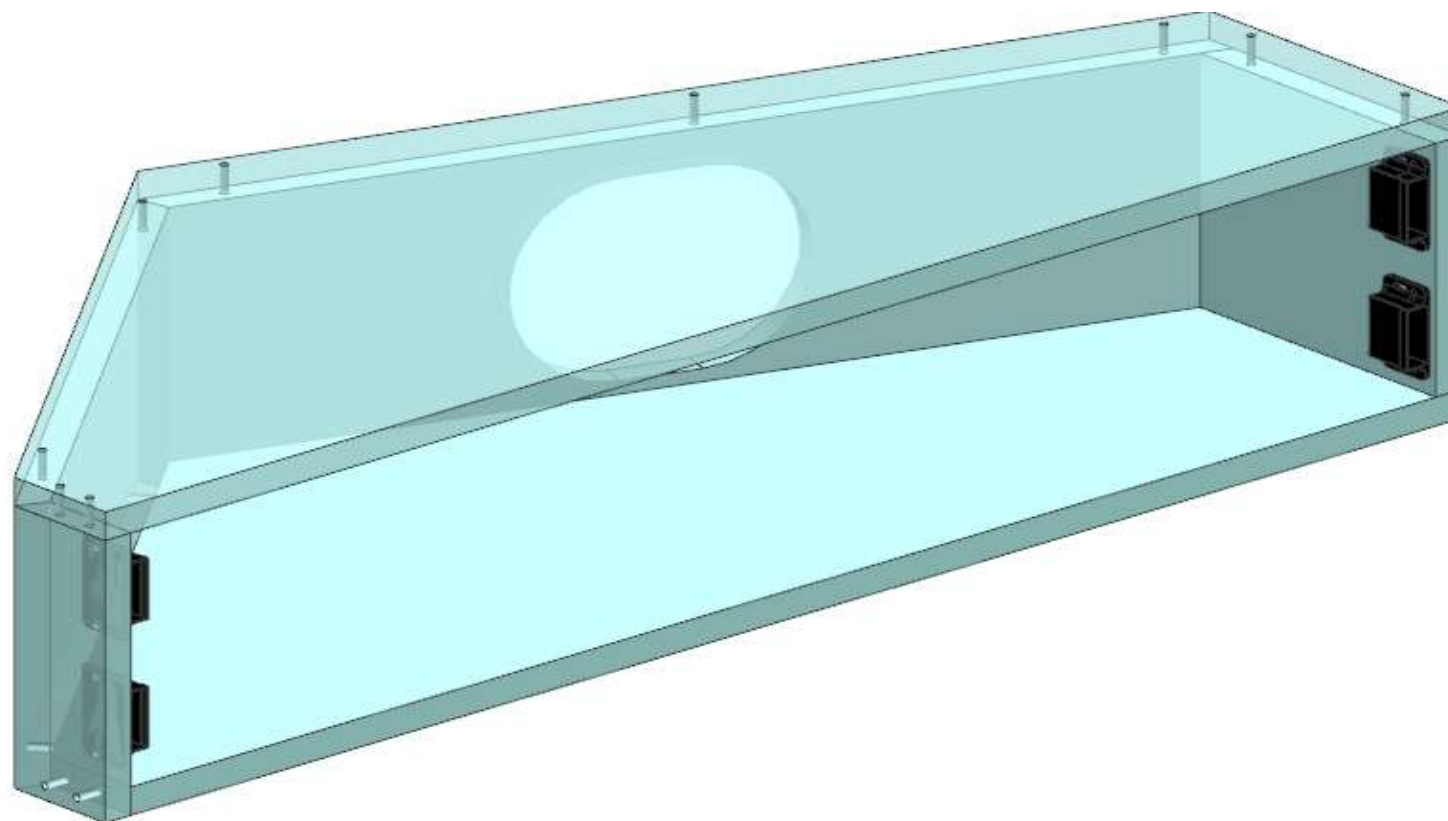

FERRAMENTA:

N° 4 - SOUTHCO
N° 3 - SPINA diam 8

AZ26M

REV. GR 9

LOCALE	CODICE	DESCRIZIONE COMPONENTE	FINITURA	Q.TA	OPERATORE
CABINA ARMATORE	AZ26M-R01_AR01	PLENUM ARMADIO PRUA STD-VAR1	LASTRA CHIARA	1	Damiano

1 - L 790 x H 30 x sp 25

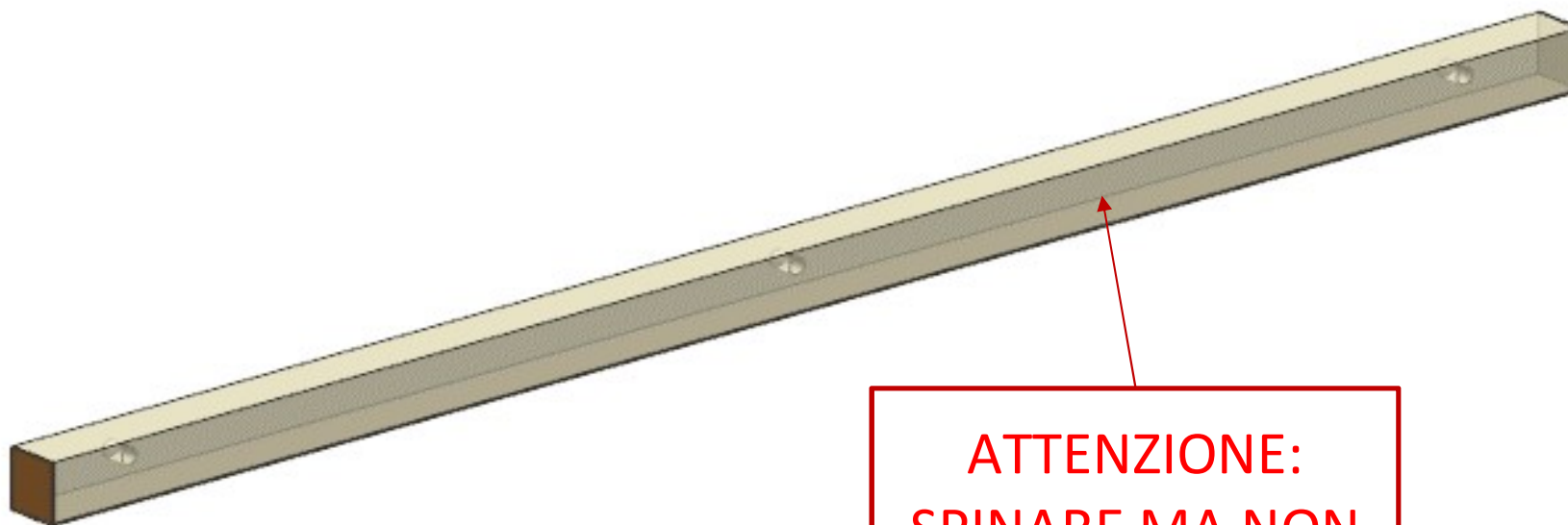

**ATTENZIONE:
SPINARE MA NON
INCOLLARE**

AZ26M

REV. GR 9

LOCALE	CODICE	DESCRIZIONE COMPONENTE	FINITURA	Q.TA	OPERATORE
CABINA ARMATORE	AZ26M-L01_AR01	PLENUM ARMADIO PRUA STD-VAR1	LACCATO BRONZO\ GREZZO VERNICIATO	1	Damiano

1 - L 795 x H 164 x sp 16

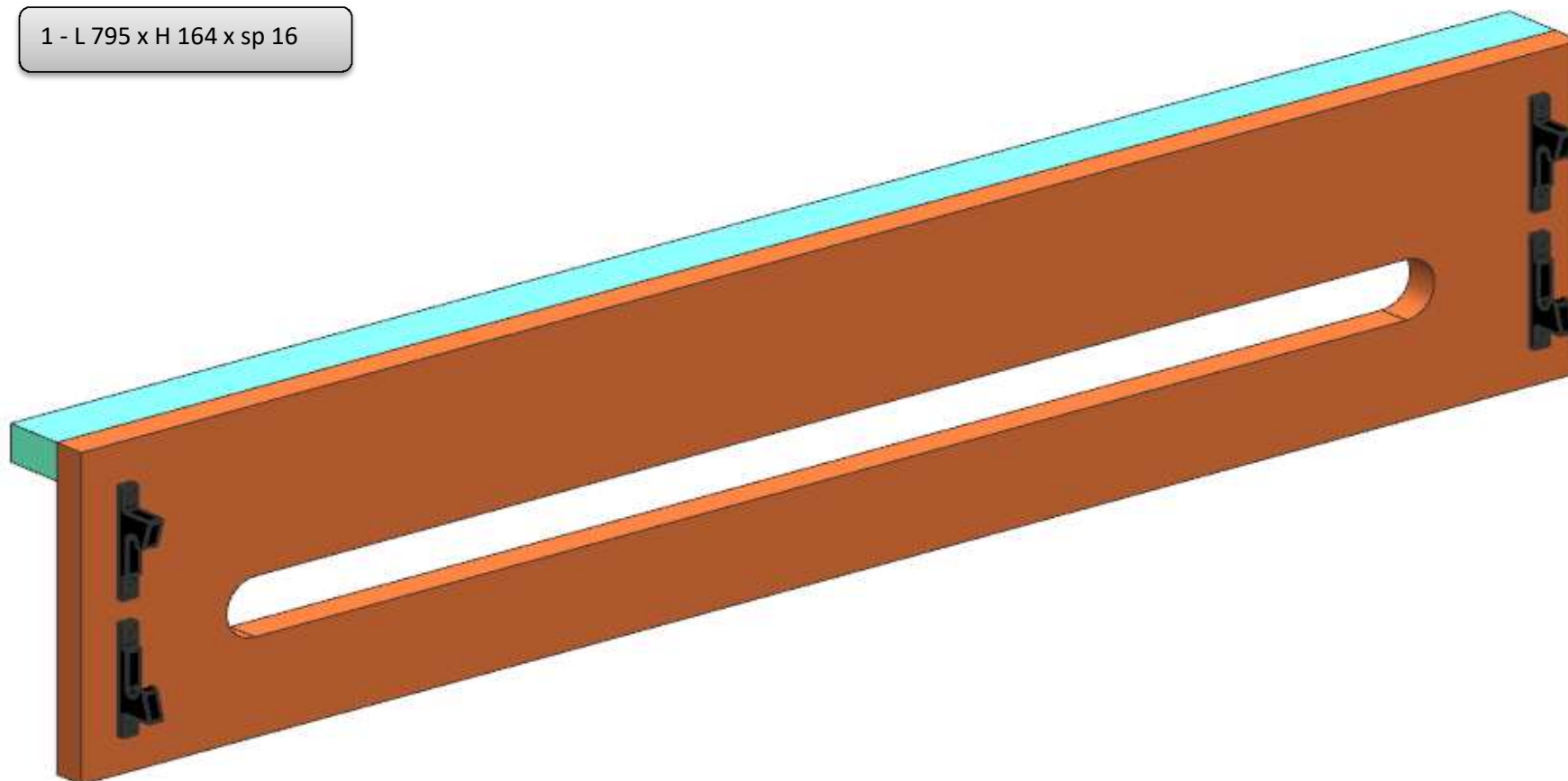

consonni&c