

LOCALE	CODICE	DESCRIZIONE COMPONENTE	FINITURA	GR.
LOBBY LD	MD320_R01_CA01	SCALA	LASTRA SCURA	2

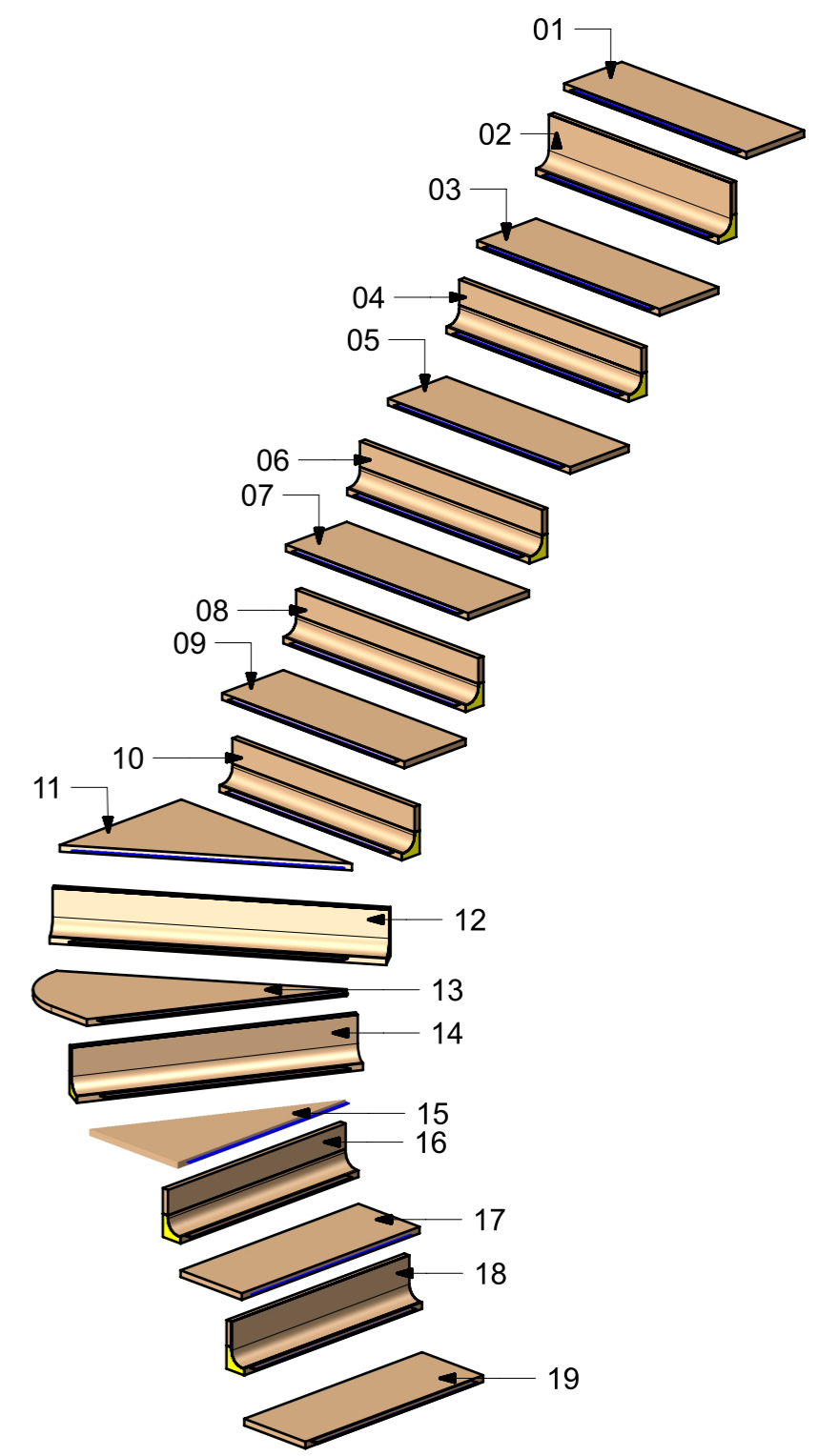
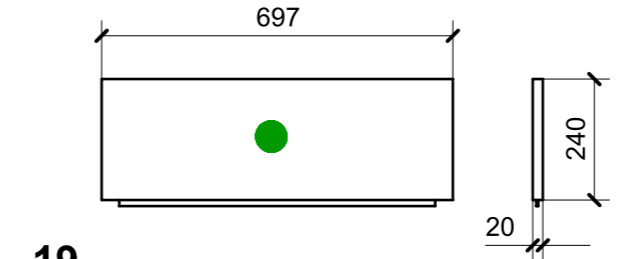
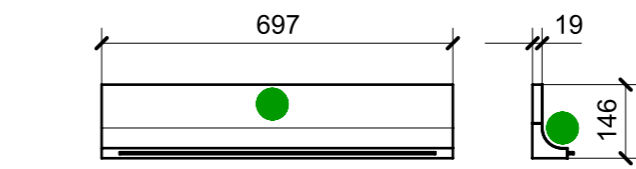
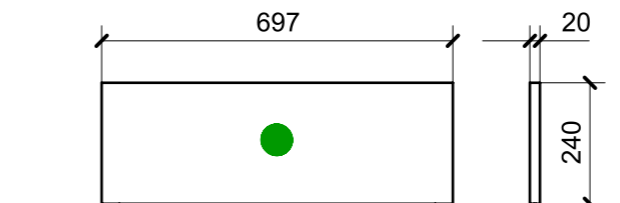
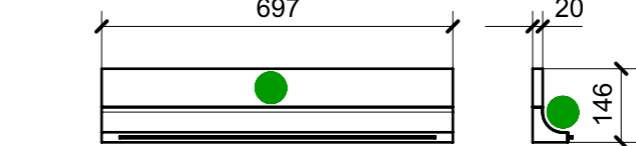
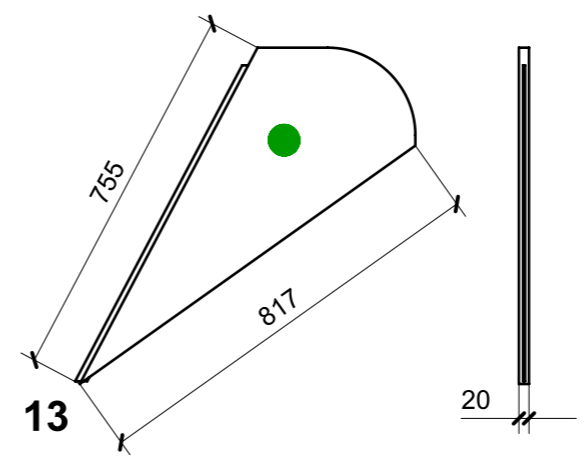
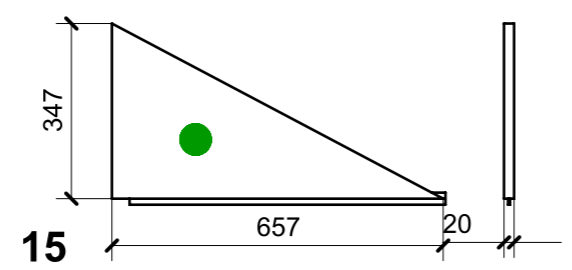
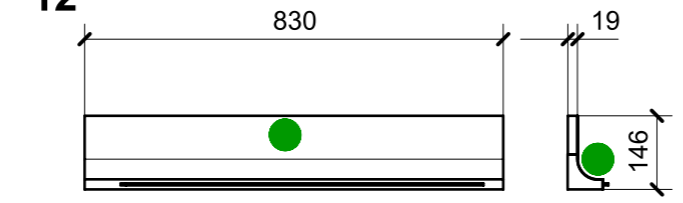
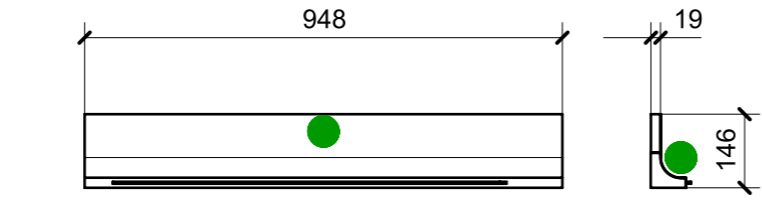
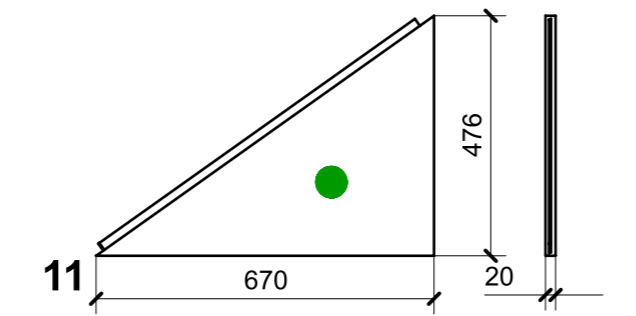
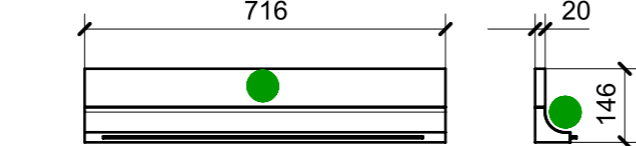
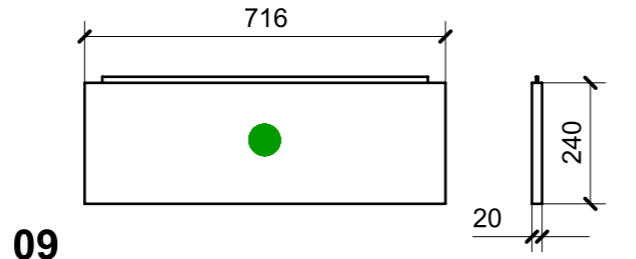
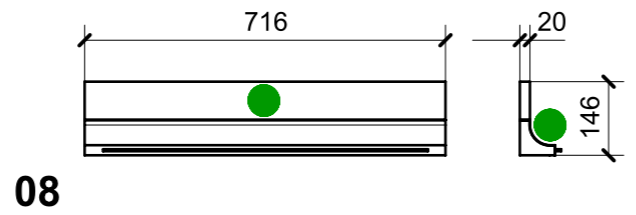
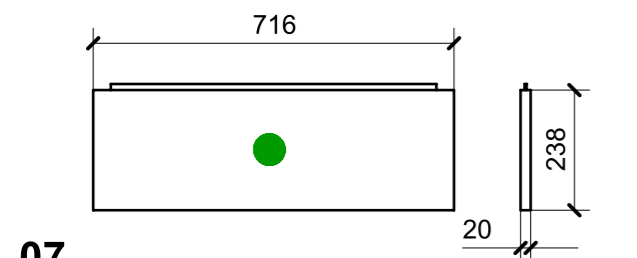
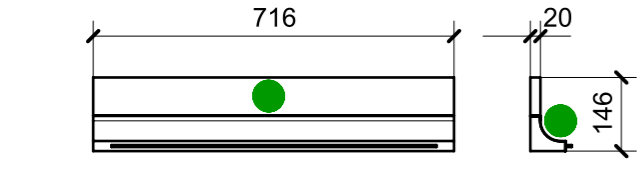
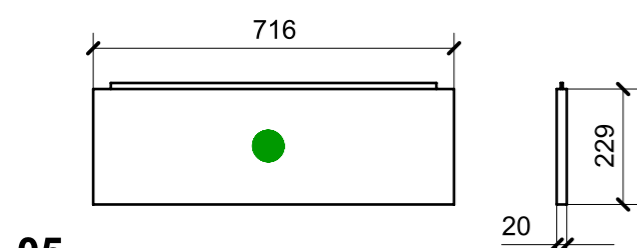
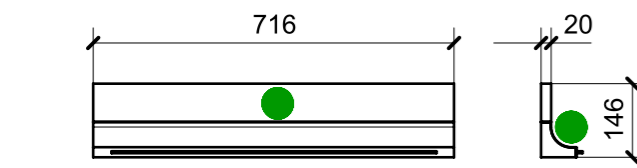
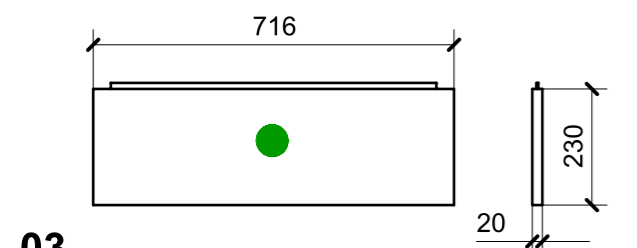
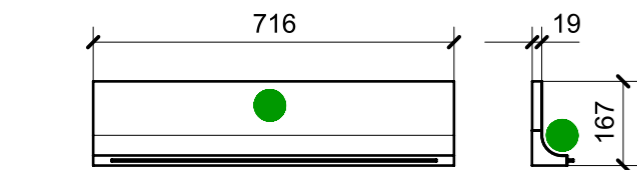
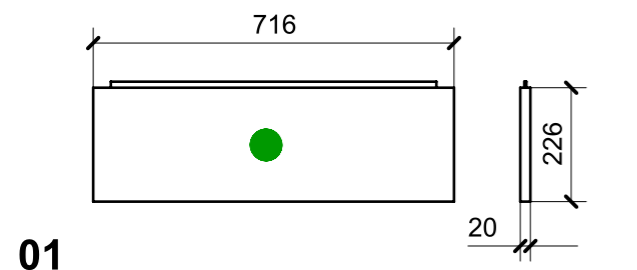

VERNICIATURA LASTRA/LACCATI:

● = FILI RASATI

● = VERNICIARE 1 LATO + FILI RASATI O BORDATI

NESSUN SIMBOLO = VERNICIARE 2 LATI + FILI RASATI O BORDATI

LOCALE	CODICE	DESCRIZIONE COMPONENTE	FINITURA	GR.
LOBBY LD	MD320_R02_CA01	SCALA	LASTRA CHIARA	2

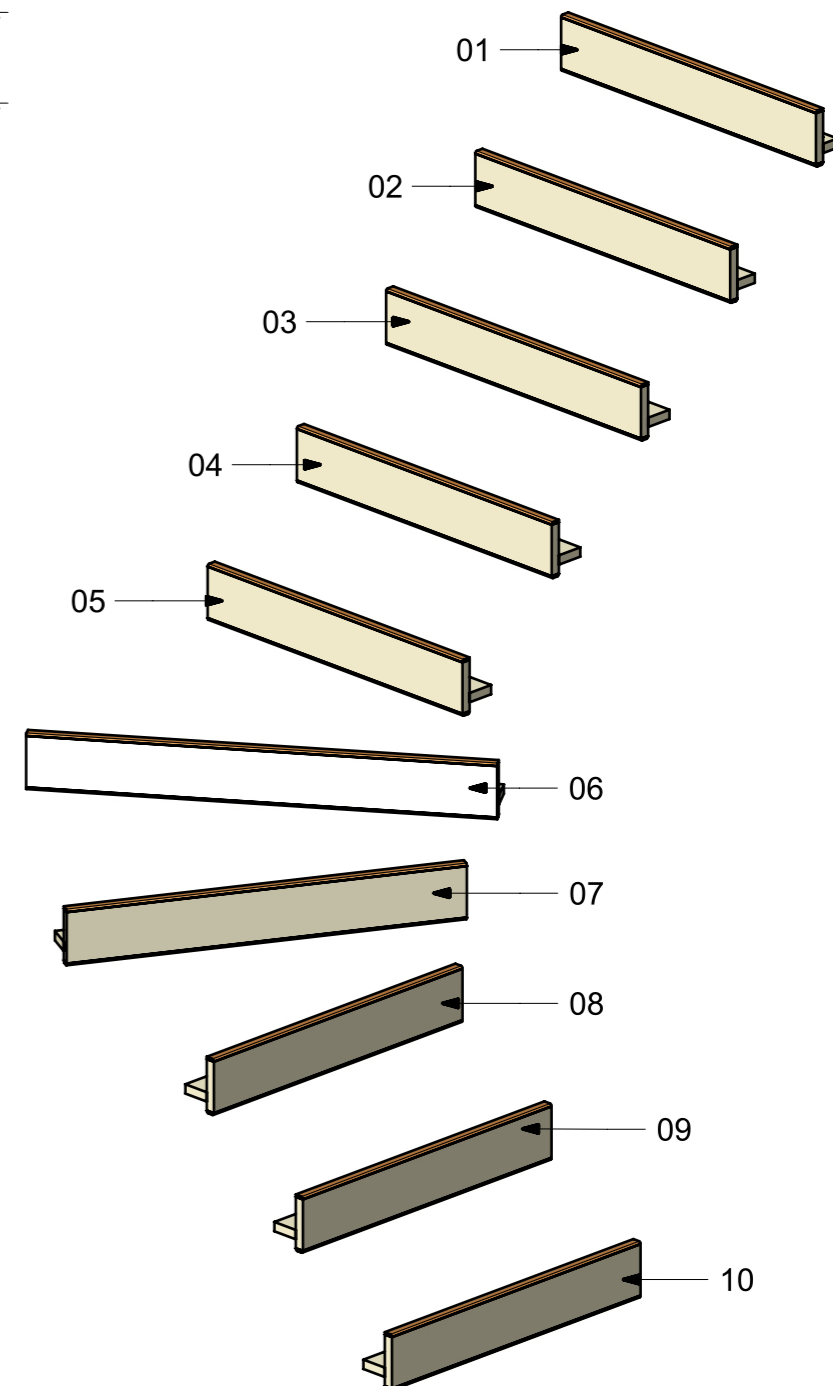
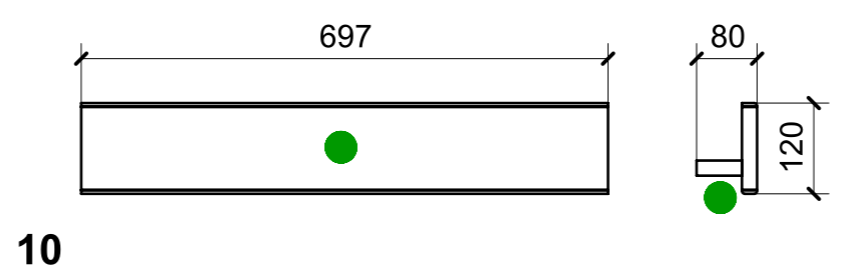
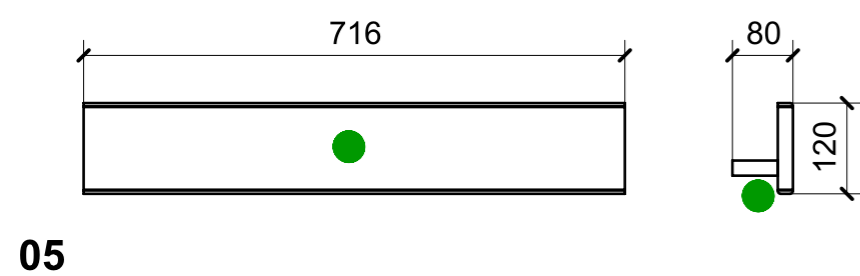
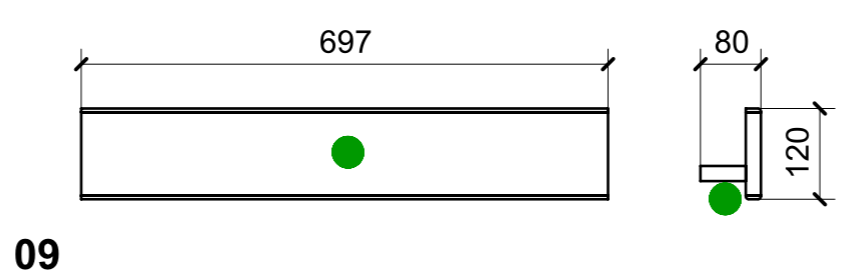
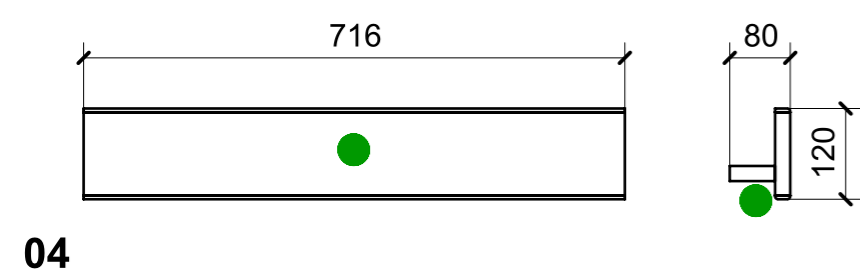
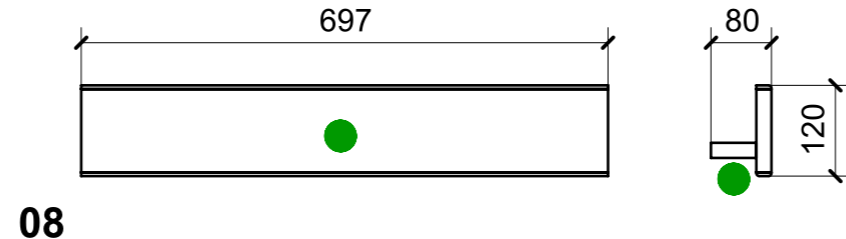
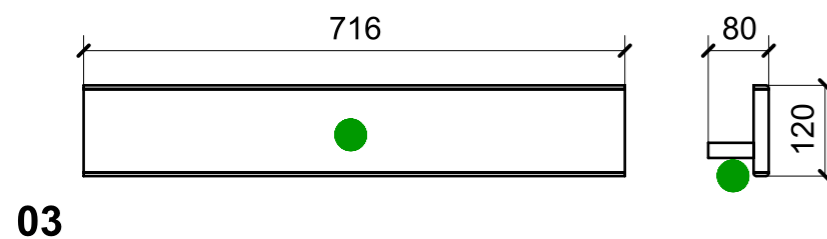
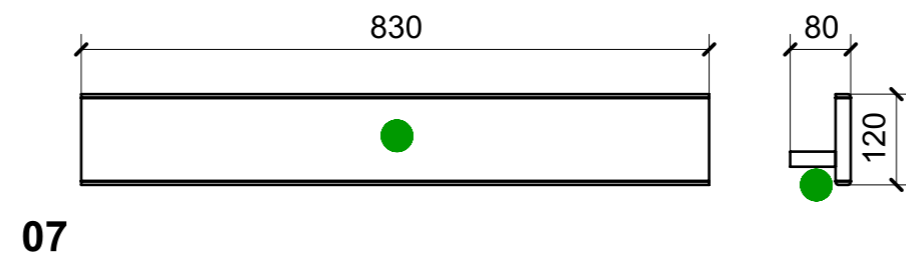
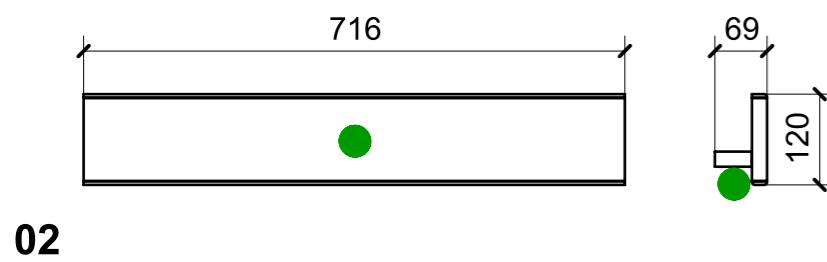
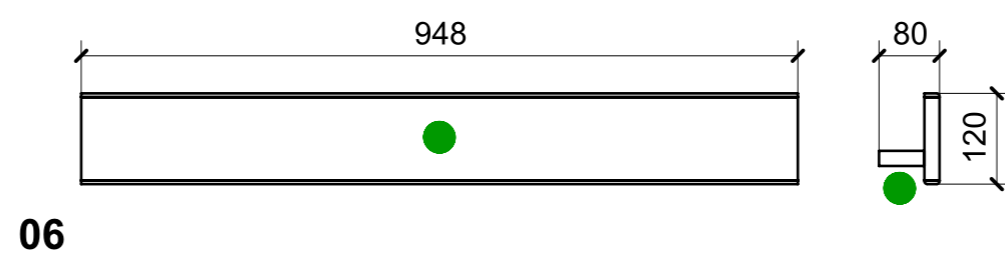
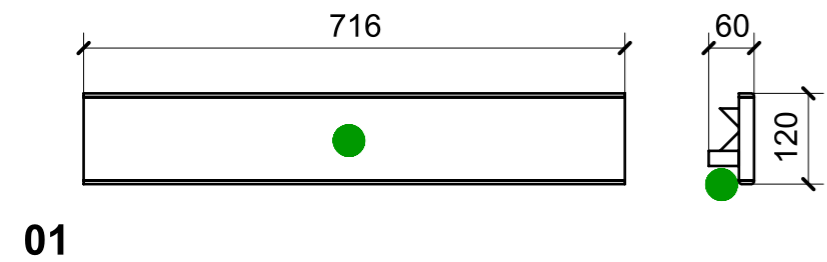

VERNICIATURA LASTRA/LACCATI:

● = VERNICIARE 1 LATO + FILI RASATI O BORDATI

NESSUN SIMBOLO = VERNICIARE 2 LATI + FILI RASATI O BORDATI

LOCALE	CODICE	DESCRIZIONE COMPONENTE	FINITURA	GR.
LOBBY LD	MD320_R02_CB01	RIVESTIMENTI POPPA DX	LASTRA CHIARA	2

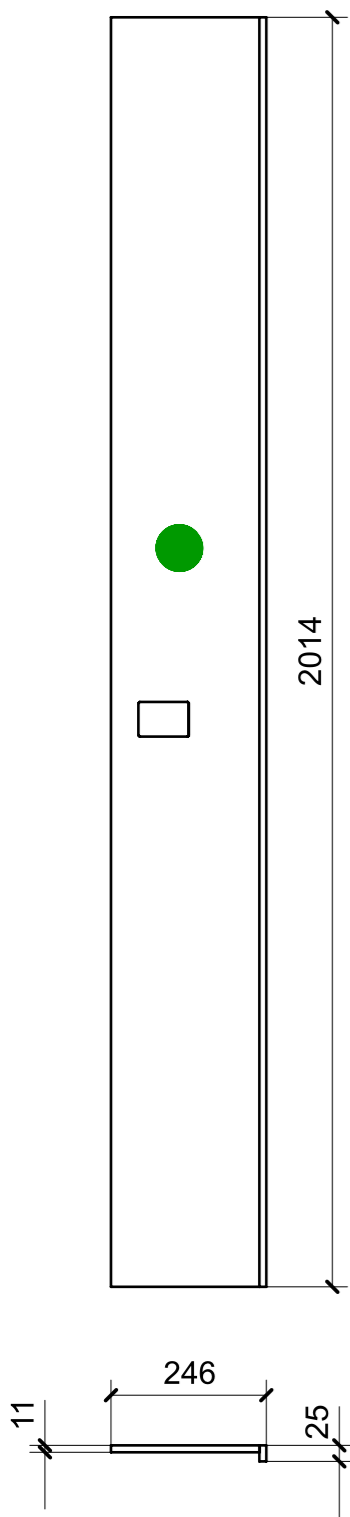

01

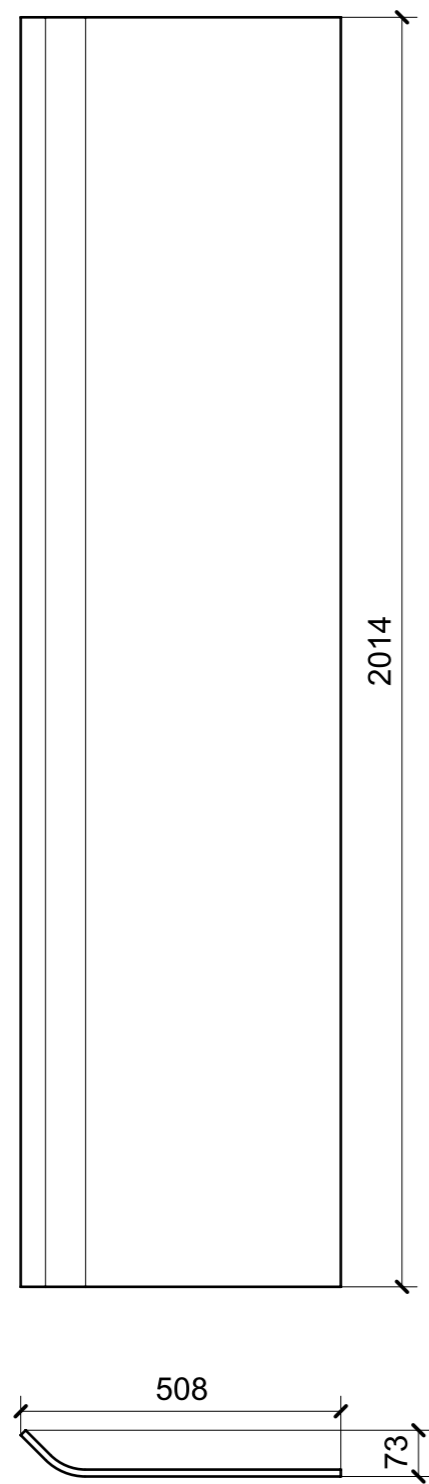

02

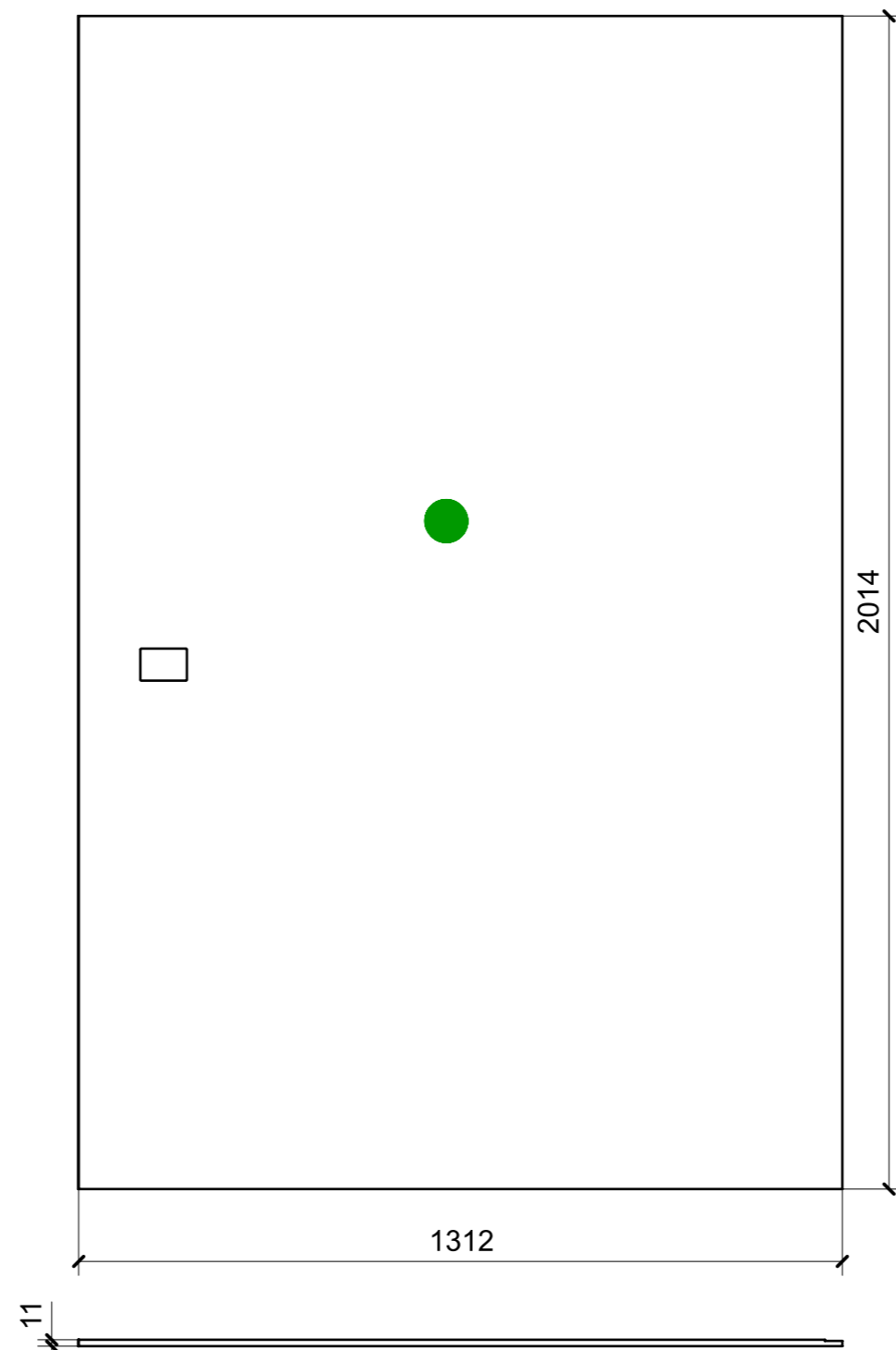

03

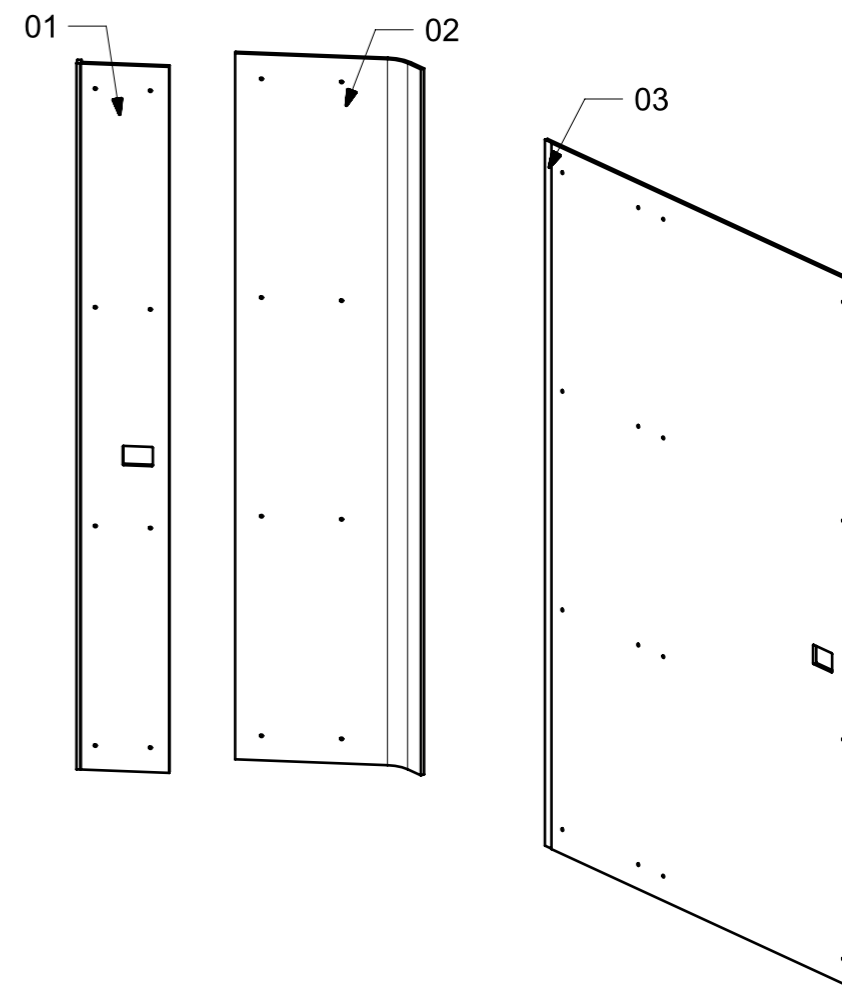

VERNICIATURA LASTRA/LACCATI:

● = FILI RASATI

● = VERNICIARE 1 LATO + FILI RASATI O BORDATI

NESSUN SIMBOLO = VERNICIARE 2 LATI + FILI RASATI O BORDATI

LOCALE	CODICE	DESCRIZIONE COMPONENTE	FINITURA	GR.
LOBBY LD	MD320_R01_CC01	RIVESTIMENTI INGRESSO CABINA OSPITI DX	LASTRA SCURA	3

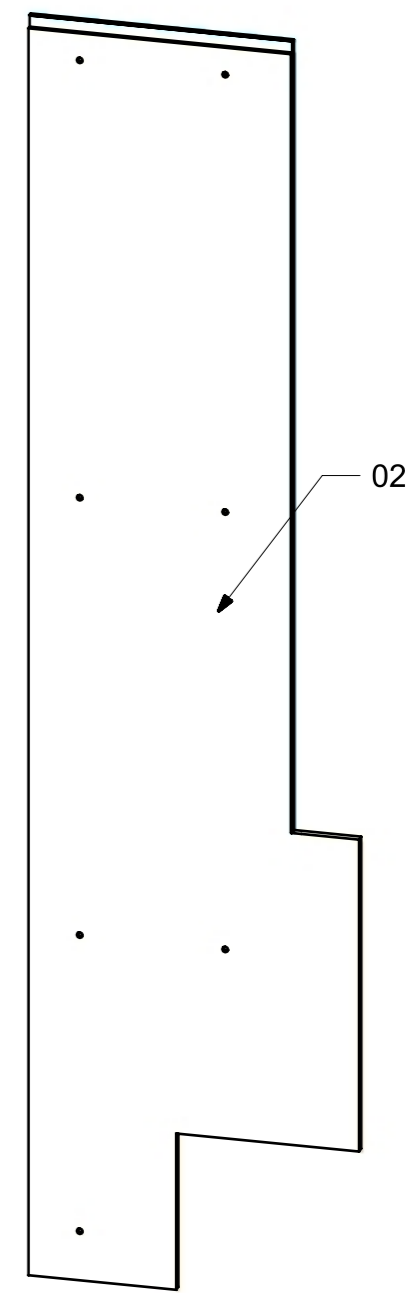
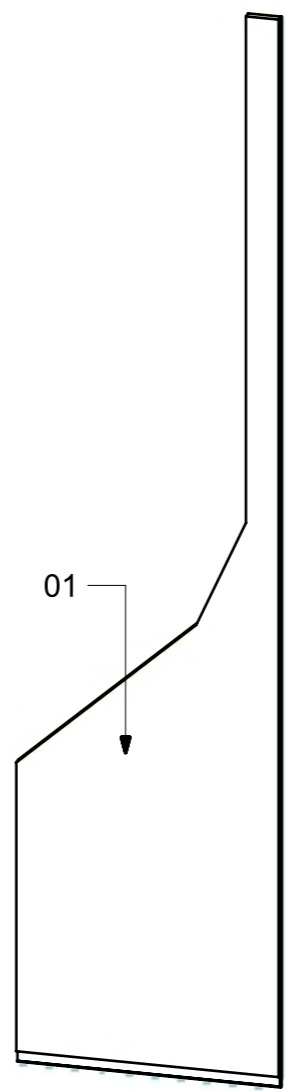
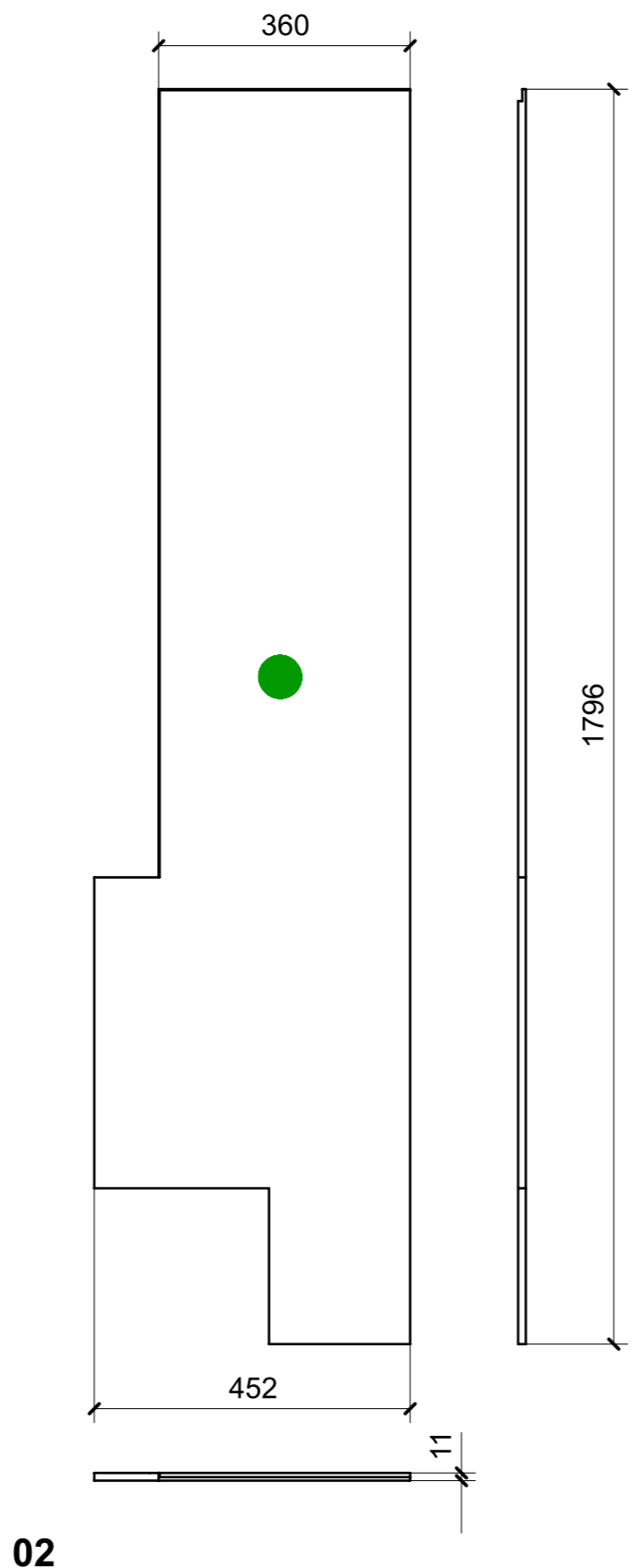
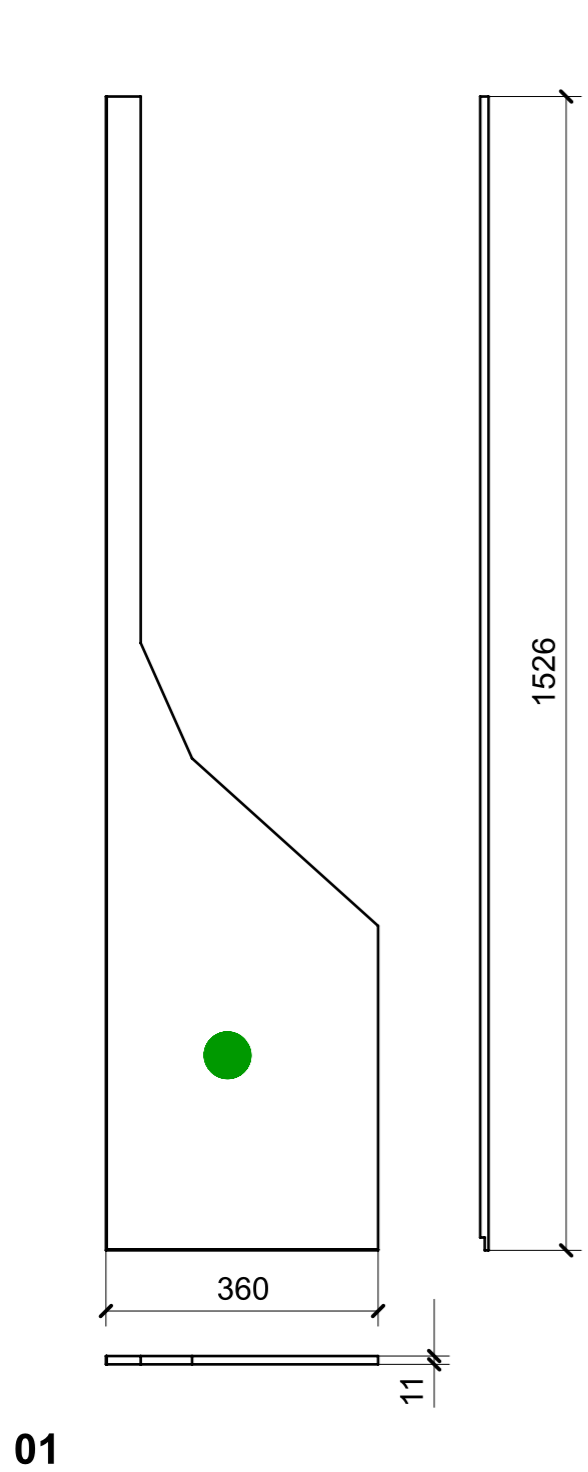

VERNICIATURA LASTRA/LACCATI:

● = VERNICIARE 1 LATO + FILI RASATI O BORDATI

NESSUN SIMBOLO = VERNICIARE 2 LATI + FILI RASATI O BORDATI

LOCALE	CODICE	DESCRIZIONE COMPONENTE	FINITURA	GR.
LOBBY LD	MD320_R02_CC01	RIVESTIMENTI INGRESSO CABINA OSPITI DX	LASTRA CHIARA	3

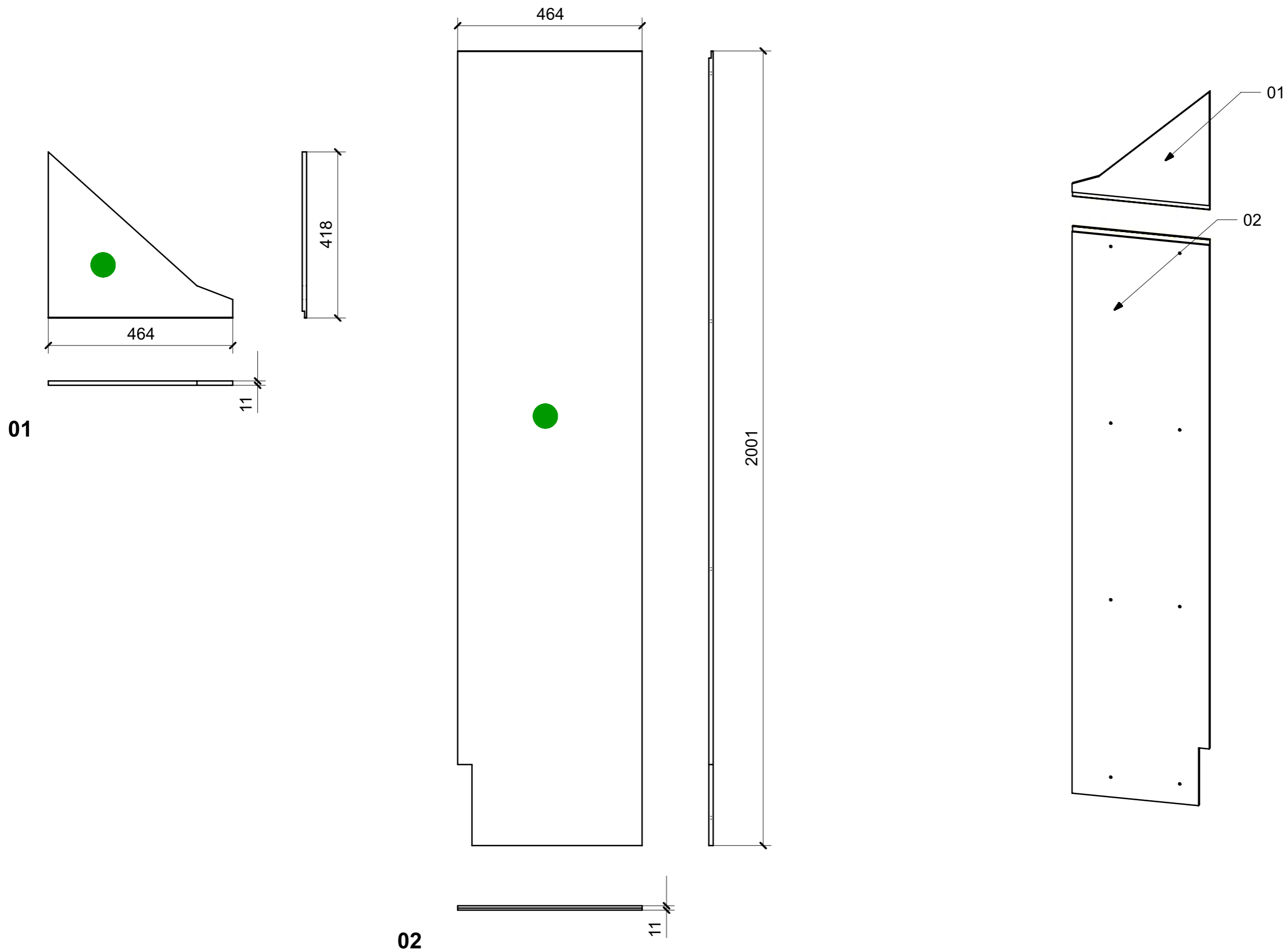

VERNICIATURA LASTRA/LACCATI:

● = FILI RASATI

● = VERNICIARE 1 LATO + FILI RASATI O BORDATI

NESSUN SIMBOLO = VERNICIARE 2 LATI + FILI RASATI O BORDATI

LOCALE	CODICE	DESCRIZIONE COMPONENTE	FINITURA	GR.
LOBBY LD	MD320_R01_CD01	RIVESTIMENTI TRAVERSONAVE DISCESA SCALE POPPA	LASTRA SCURA	PTP

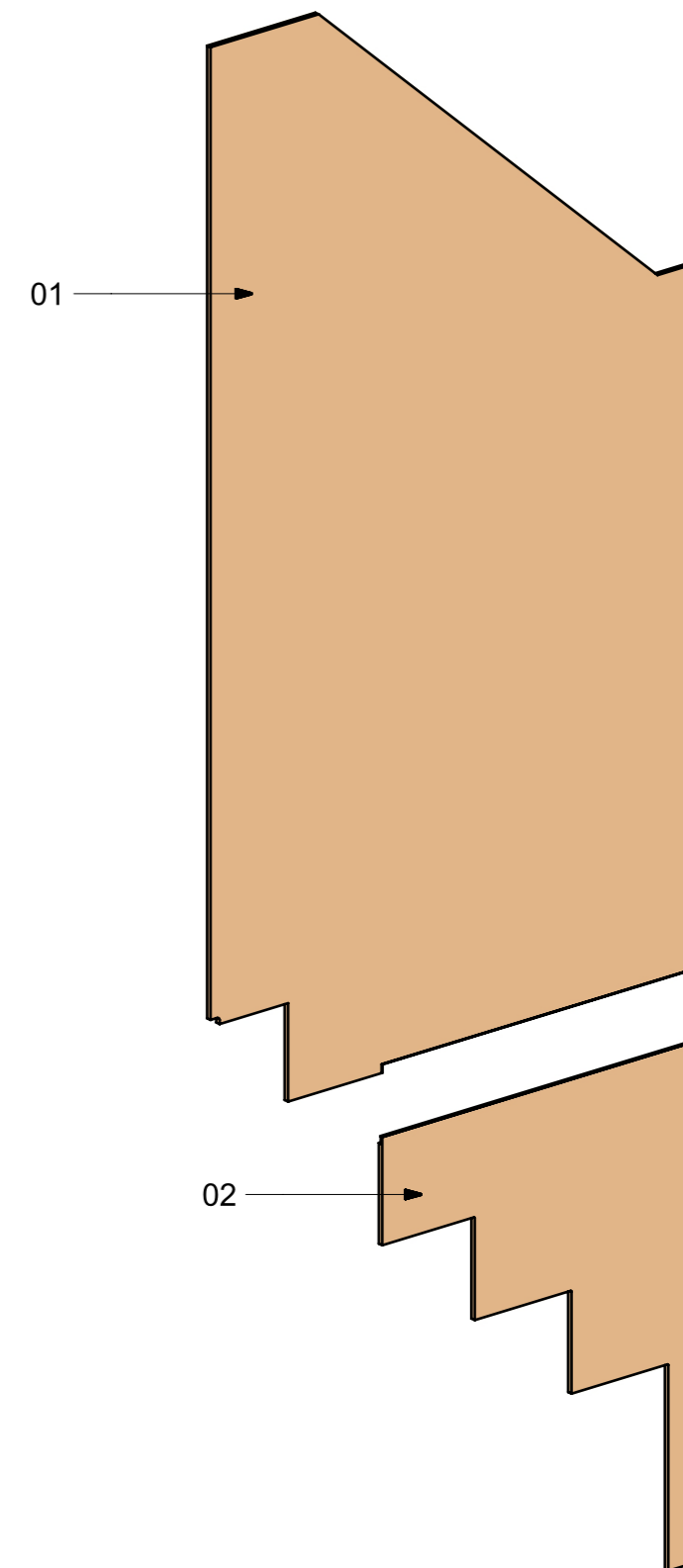
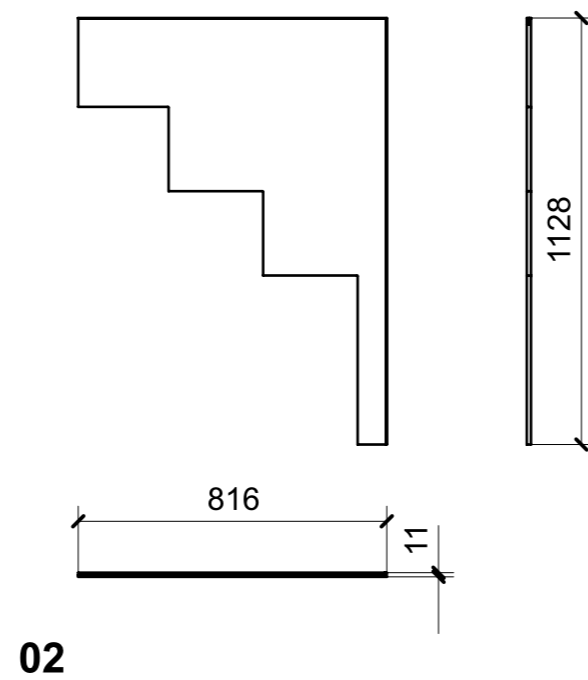
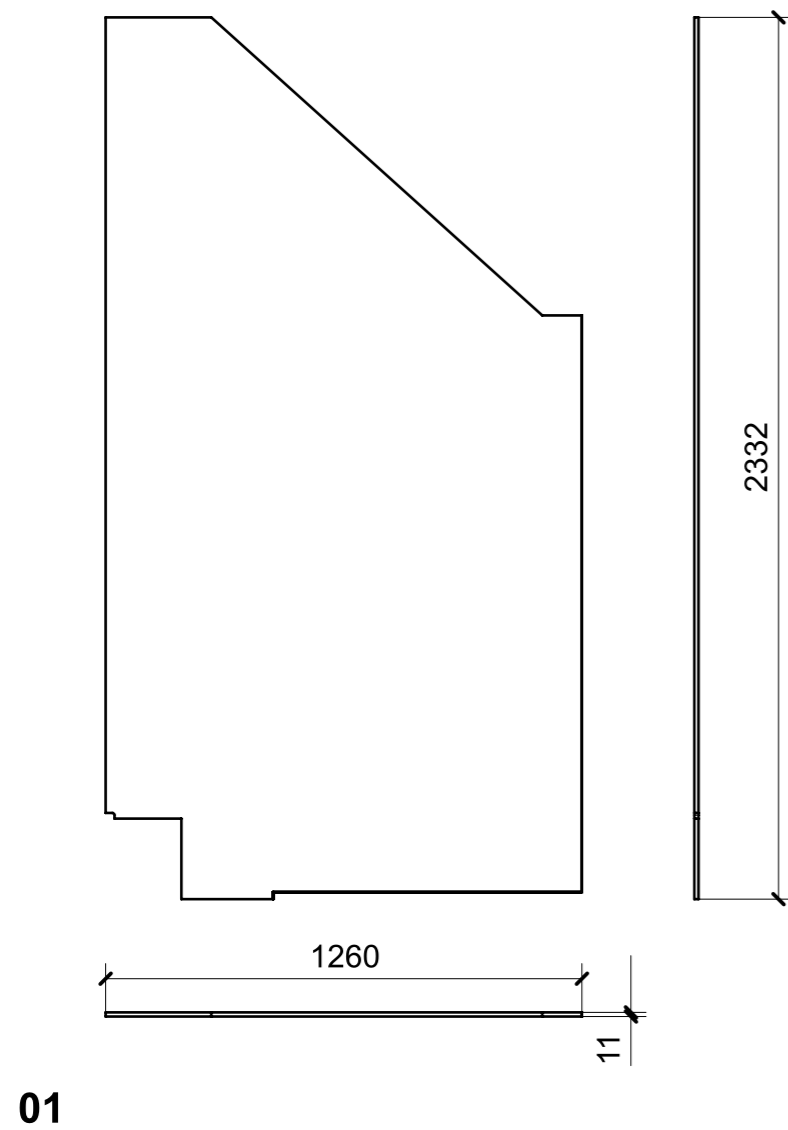

VERNICIATURA LASTRA/LACCATI:

● = FILI RASATI

● = VERNICIARE 1 LATO + FILI RASATI O BORDATI

NESSUN SIMBOLO = VERNICIARE 2 LATI + FILI RASATI O BORDATI

LOCALE	CODICE	DESCRIZIONE COMPONENTE	FINITURA	GR.
LOBBY LD	MD320_R01_CE01	RIVESTIMENTI POPPA SX	LASTRA SCURA	3

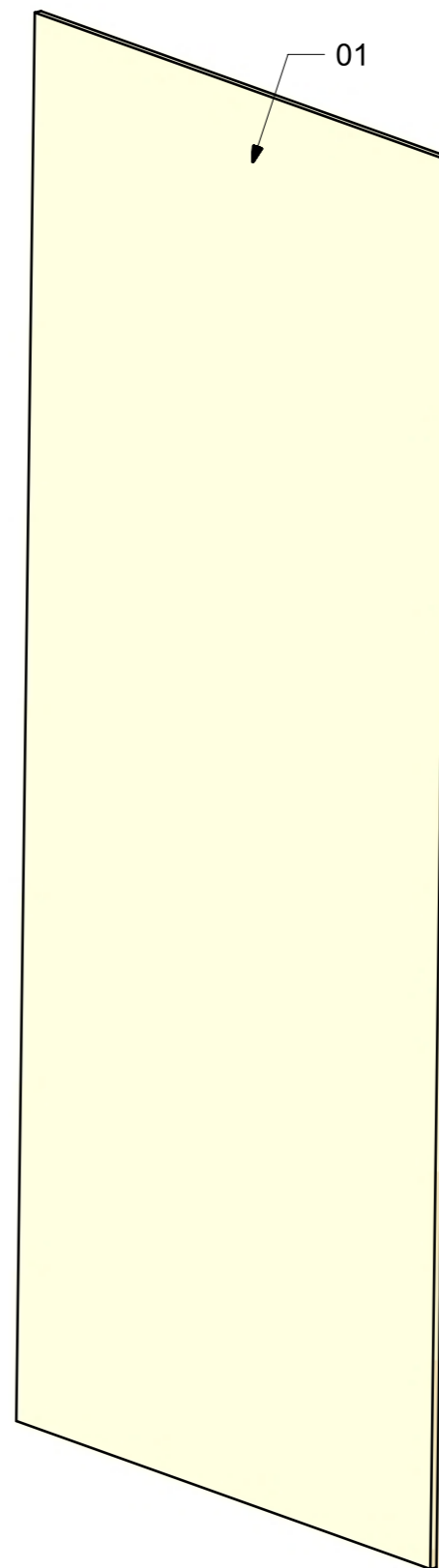
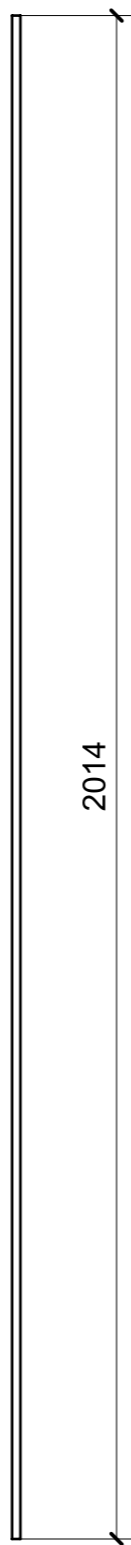
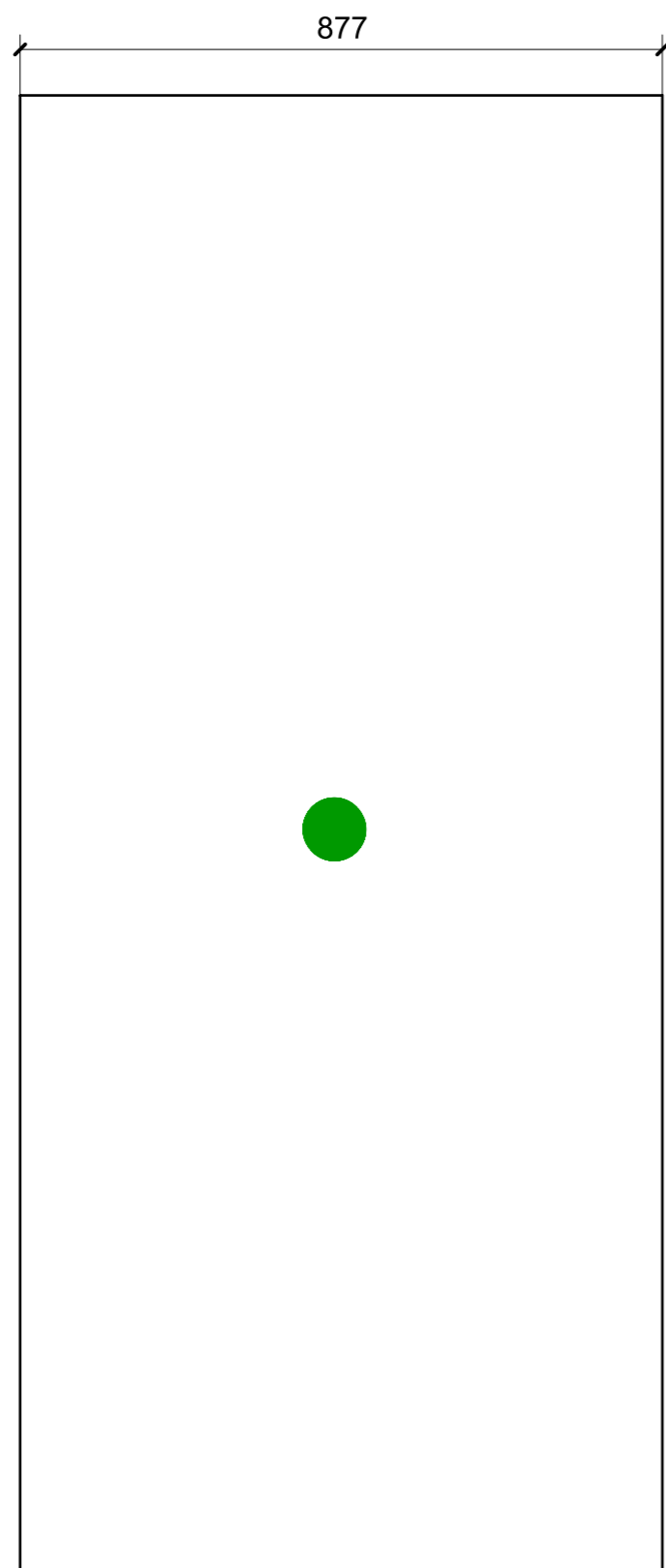

01

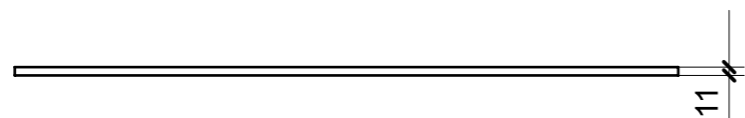

VERNICIATURA LASTRA/LACCATI:

● = VERNICIARE 1 LATO + FILI RASATI O BORDATI

NESSUN SIMBOLO = VERNICIARE 2 LATI + FILI RASATI O BORDATI

LOCALE	CODICE	DESCRIZIONE COMPONENTE	FINITURA	GR.
LOBBY LD	MD320_R02_CE01	RIVESTIMENTI POPPA SX	LASTRA CHIARA	3

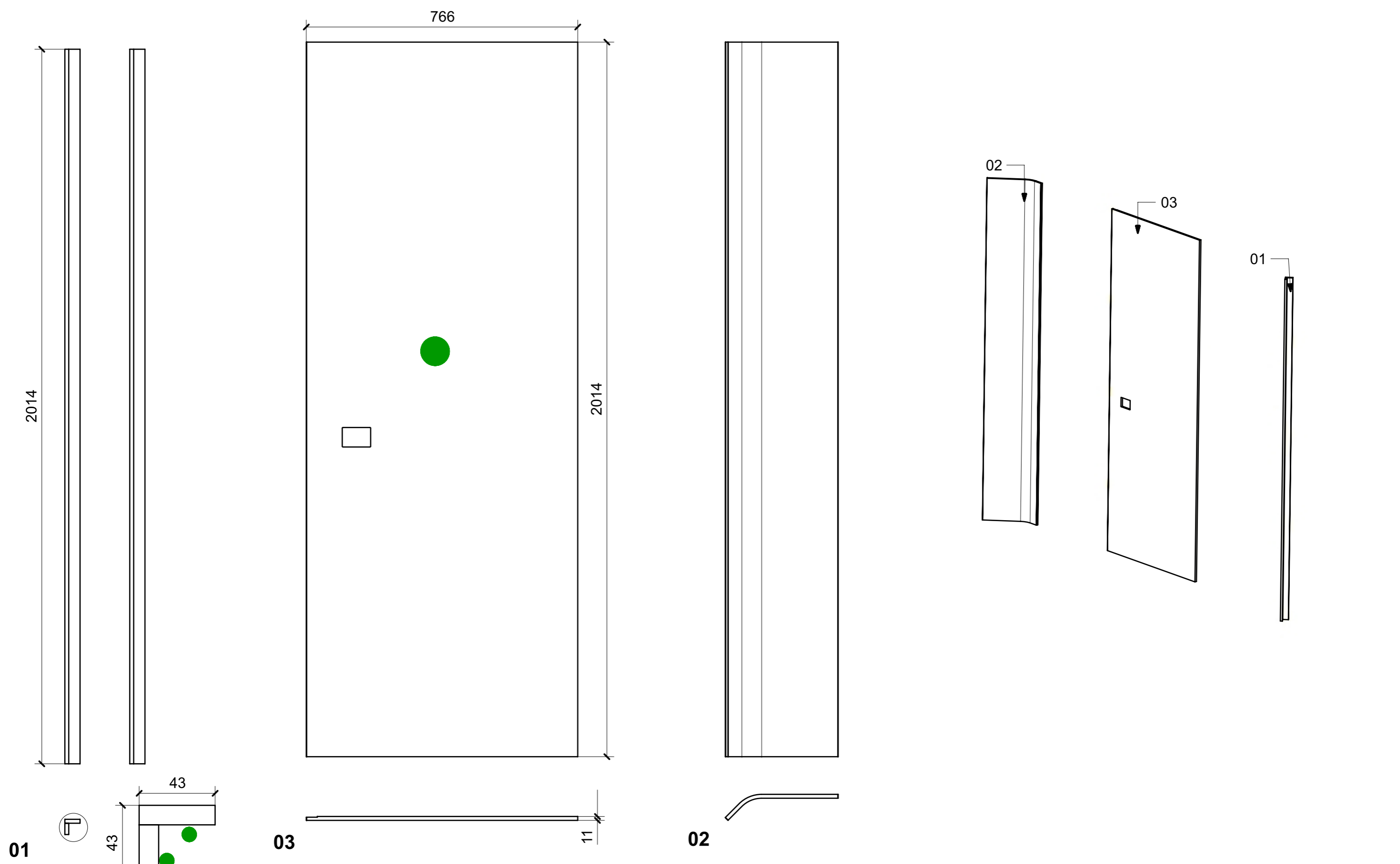

VERNICIATURA LASTRA/LACCATI:

● = VERNICIARE 1 LATO + FILI RASATI O BORDATI

NESSUN SIMBOLO = VERNICIARE 2 LATI + FILI RASATI O BORDATI

LOCALE	CODICE	DESCRIZIONE COMPONENTE	FINITURA	GR.
LOBBY LD	MD320_R01_CF01	RIVESTIMENTI PRUA SX	LASTRA SCURA	3

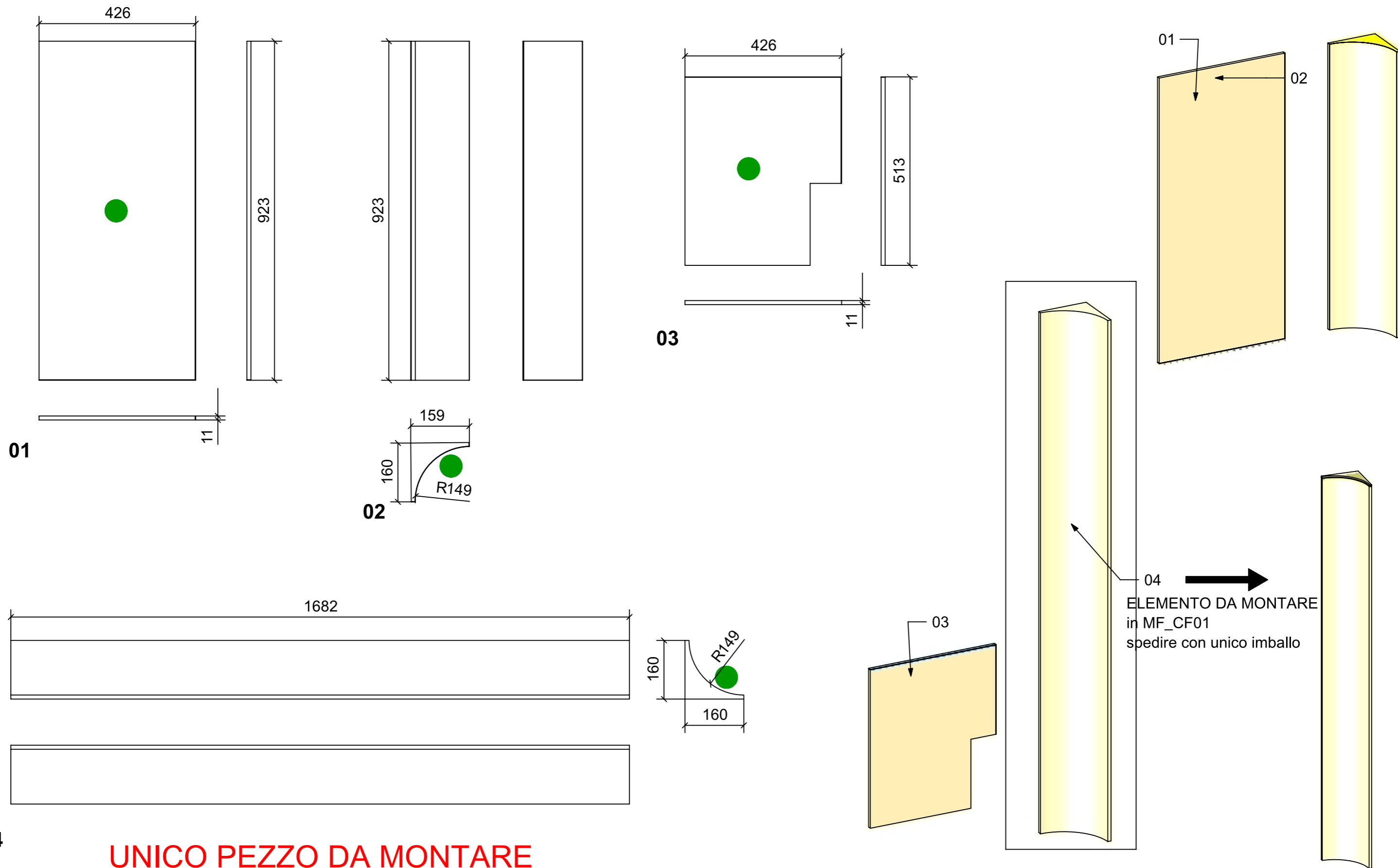

04

UNICO PEZZO DA MONTARE

VERNICIATURA LASTRA/LACCATI:

● = VERNICIARE 1 LATO + FILI RASATI O BORDATI

NESSUN SIMBOLO = VERNICIARE 2 LATI + FILI RASATI O BORDATI

LOCALE	CODICE	DESCRIZIONE COMPONENTE	FINITURA	GR.
LOBBY LD	MD320_R02_CF01	RIVESTIMENTI PRUA SX	LASTRA CHIARA	3

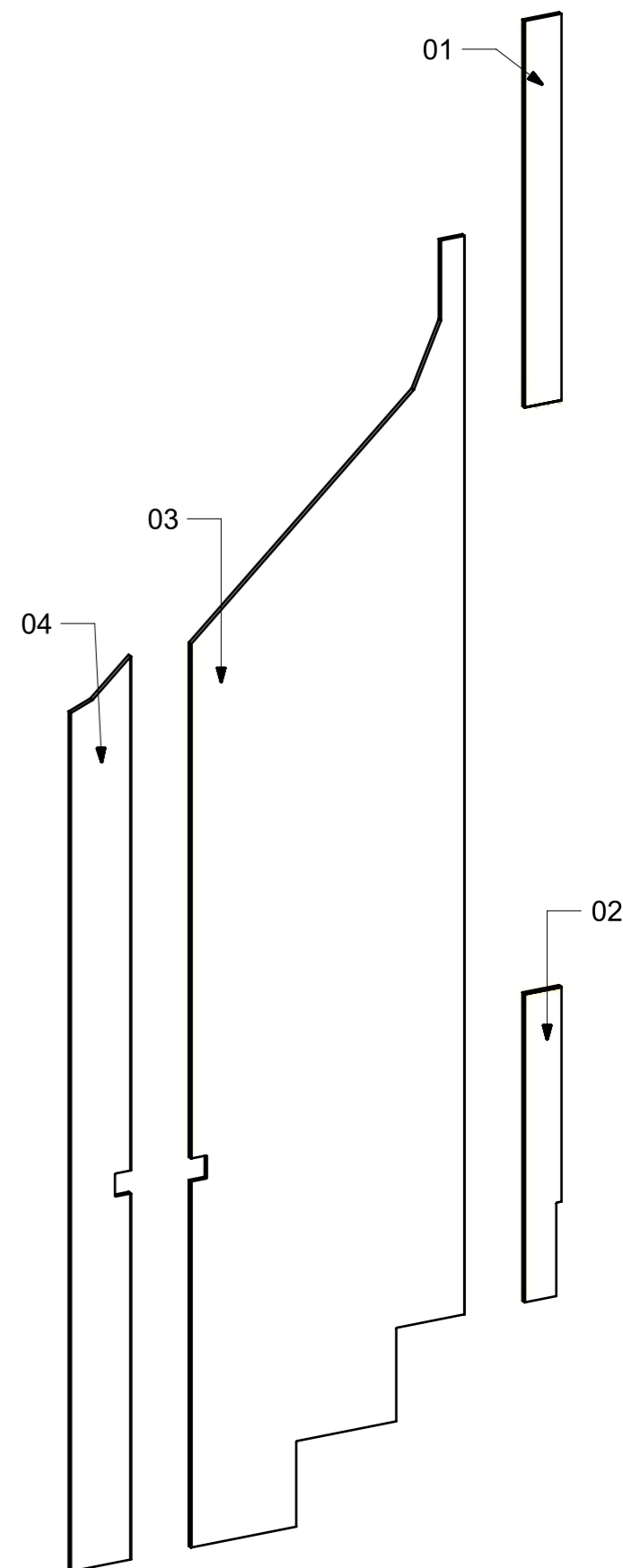
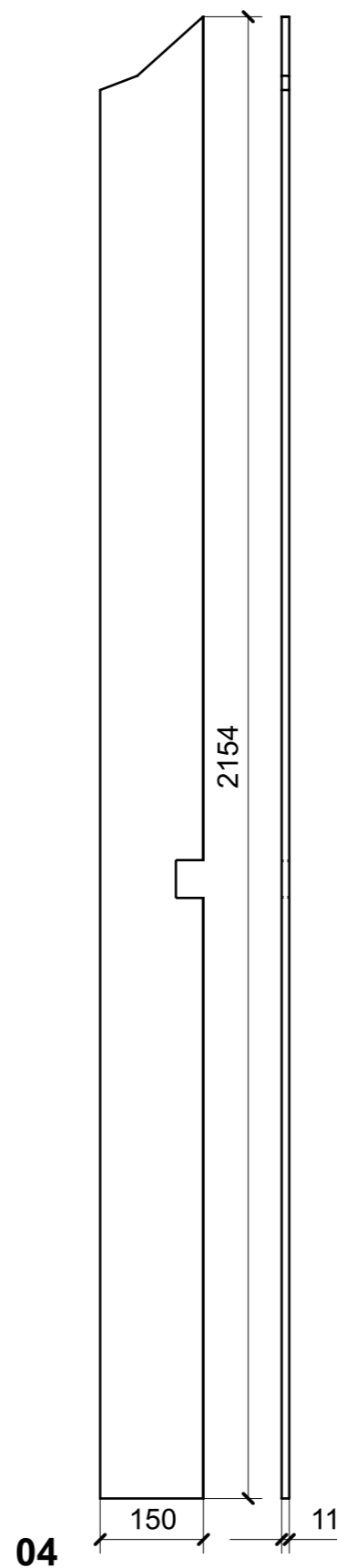
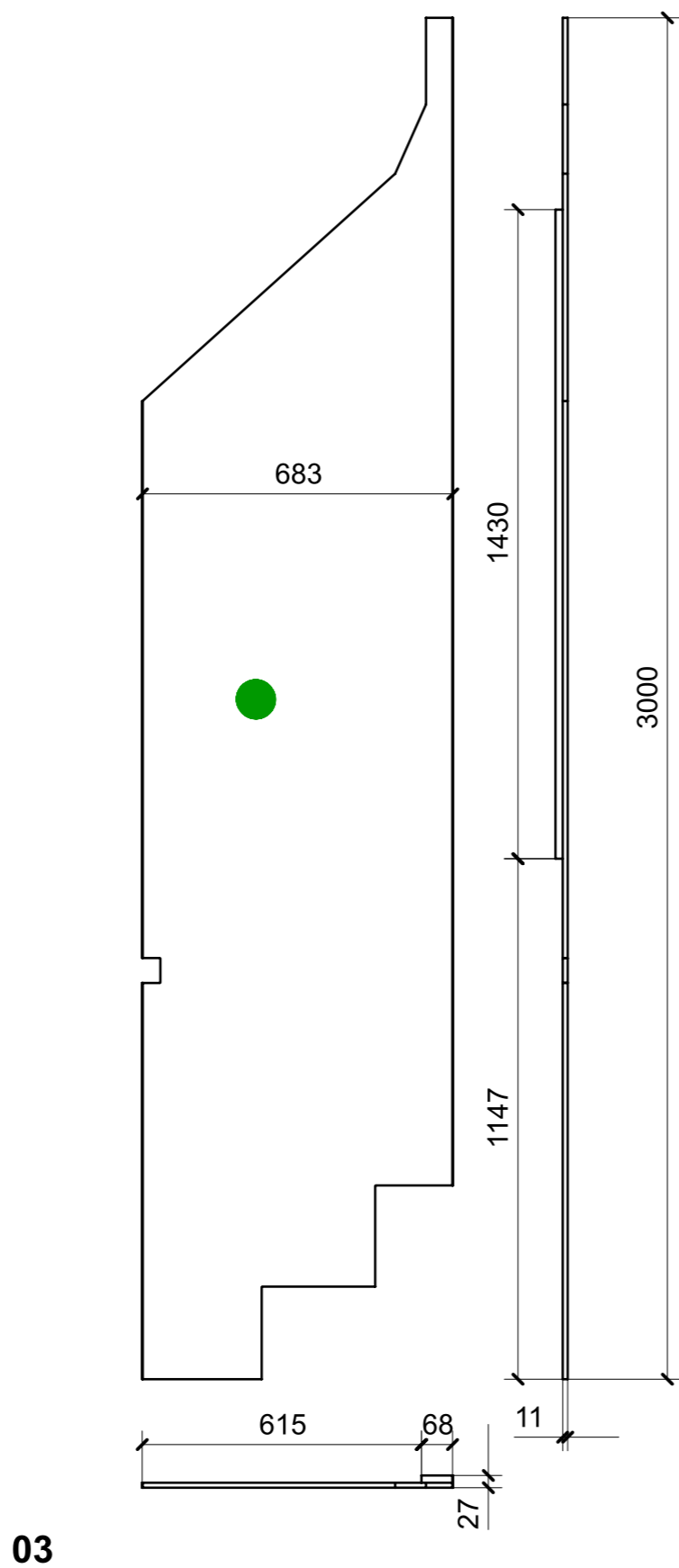
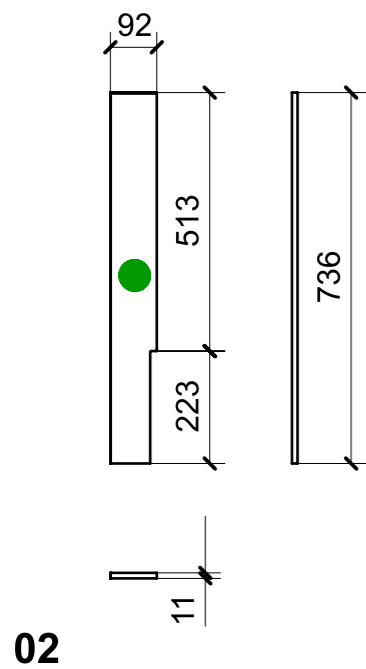
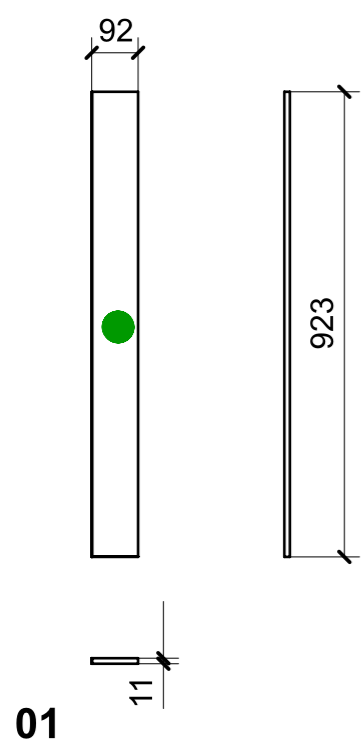

VERNICIATURA LASTRA/LACCATI:

● = VERNICIARE 1 LATO + FILI RASATI O BORDATI

NESSUN SIMBOLO = VERNICIARE 2 LATI + FILI RASATI O BORDATI

LOCALE	CODICE	DESCRIZIONE COMPONENTE	FINITURA	GR.
LOBBY LD	MD320_R01_CG01	RIVESTIMENTI TRAVERSONAVE DISCESA SCALE PRUA	LASTRA SCURA	2

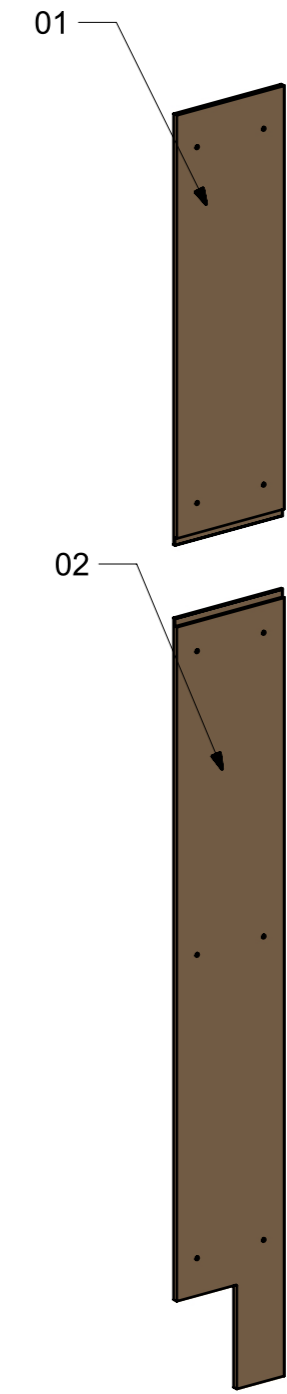
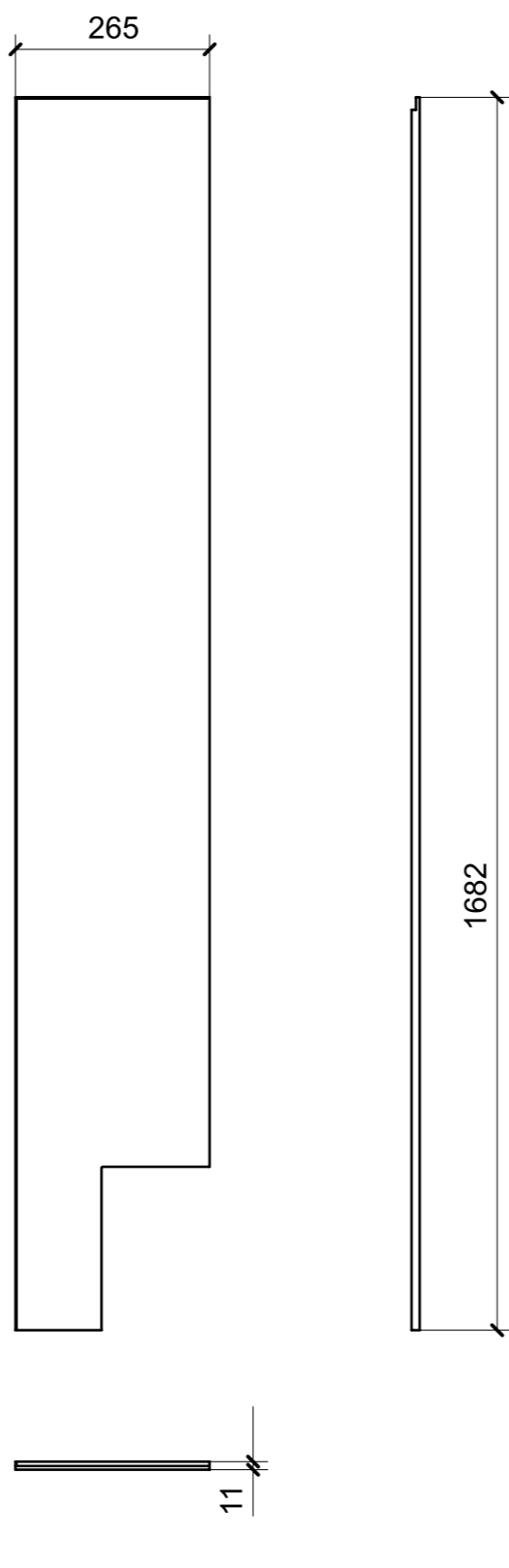
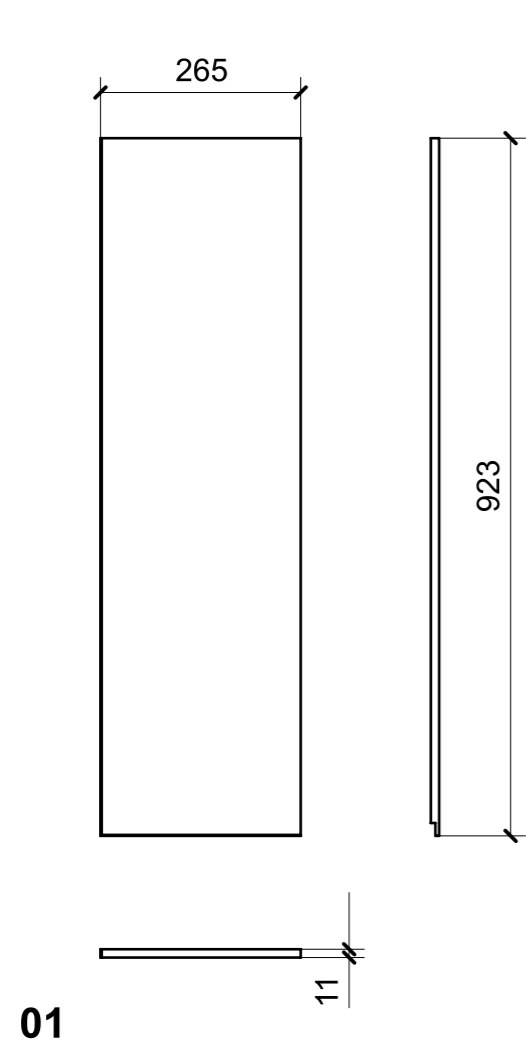

VERNICIATURA LASTRA/LACCATI:
● = VERNICIARE 1 LATO + FILI RASATI O BORDATI NESSUN SIMBOLO = VERNICIARE 2 LATI + FILI RASATI O BORDATI

LOCALE	CODICE	DESCRIZIONE COMPONENTE	FINITURA	GR.
LOBBY LD	MD320_R02_CG01	RIVESTIMENTI TRAVERSONAVE DISCESA SCALE PRUA	LASTRA CHIARA	2

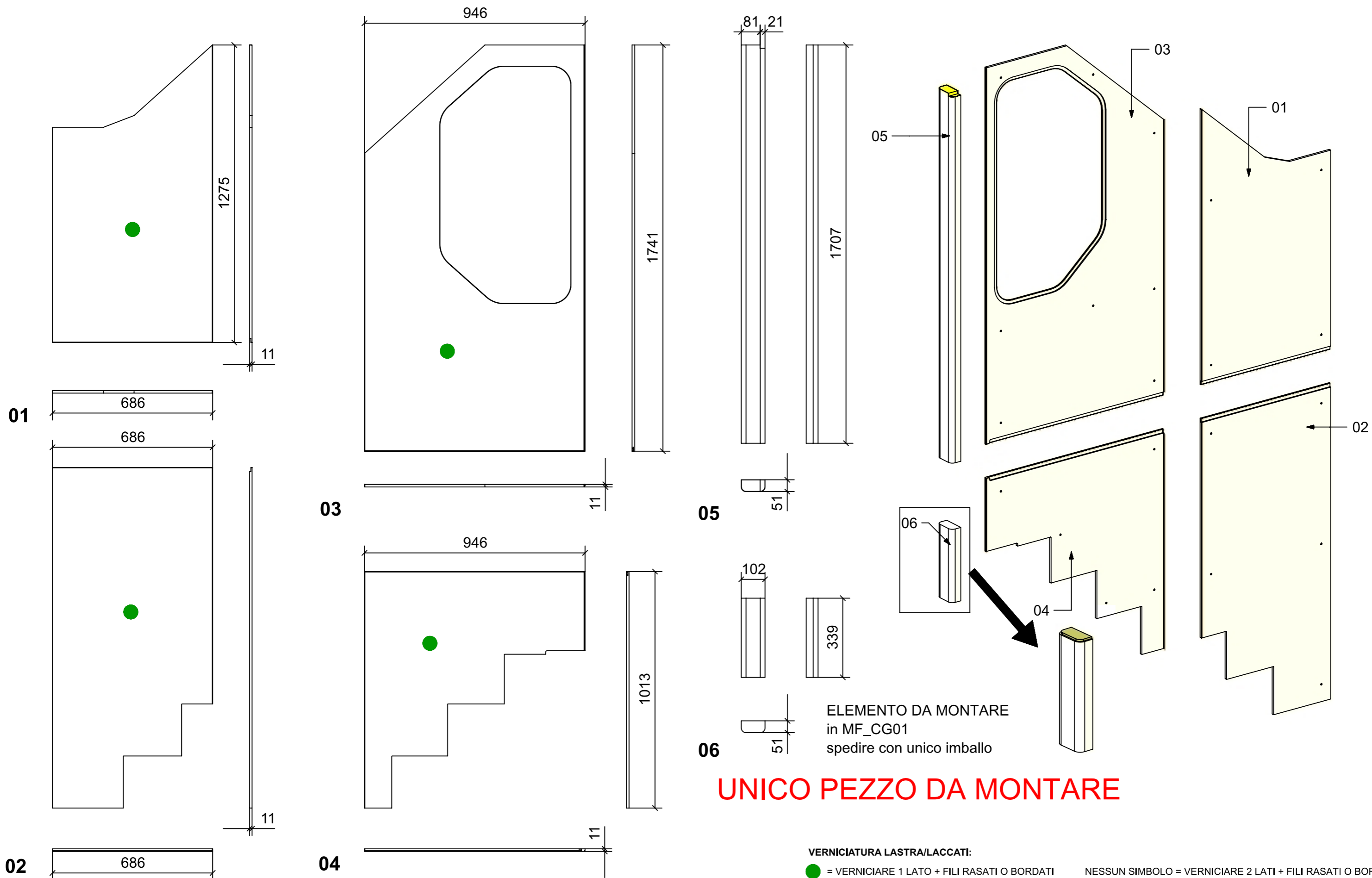

LOCALE	CODICE	DESCRIZIONE COMPONENTE	FINITURA	GR.
LOBBY LD	MD320_R01_CH01	MOBILE QUADRO ELETTRICO	LASTRA SCURA	4

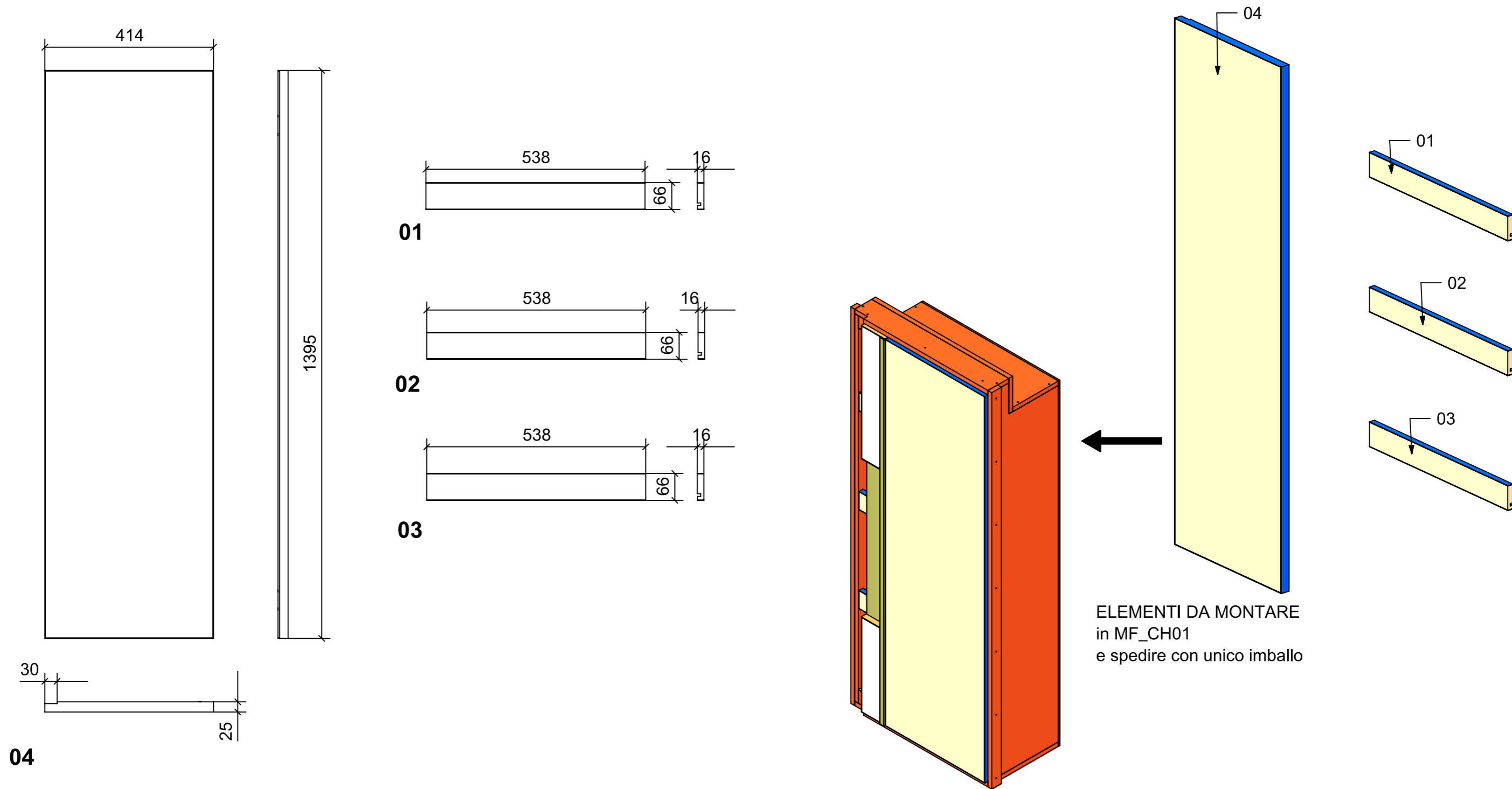

FERRAMENTA	QTY
BUSSOLA 5MAANKOR BORGHI X CERNIERA PIANA	6

VERNICIATURA LASTRA/LACCATI:

● = VERNICIARE 1 LATO + FILI RASATI O BORDATI

NESSUN SIMBOLO = VERNICIARE 2 LATI + FILI RASATI O BORDATI

LOCALE	CODICE	DESCRIZIONE COMPONENTE	FINITURA	GR.
LOBBY LD	MD320_R02_CH01	MOBILE QUADRO ELETTRICO	LASTRA CHIARA	4

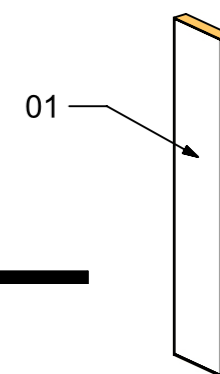
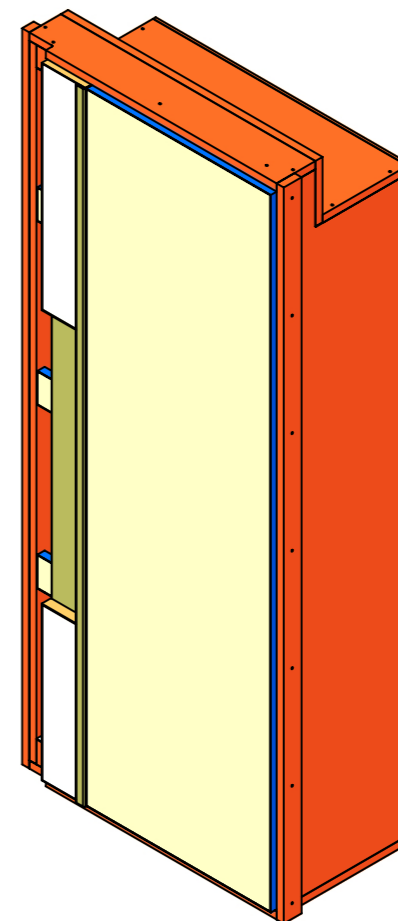
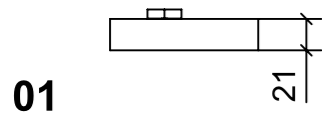
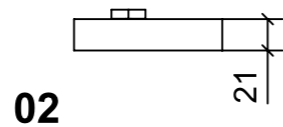
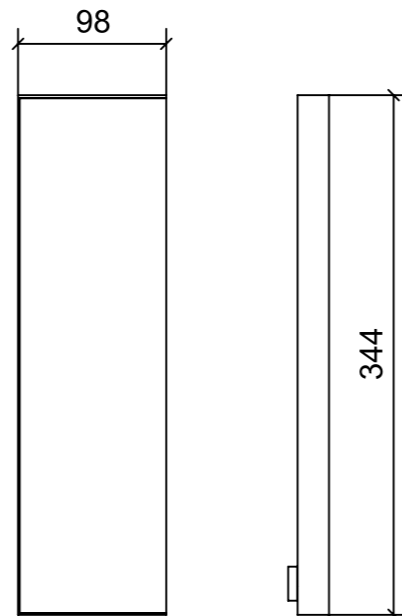
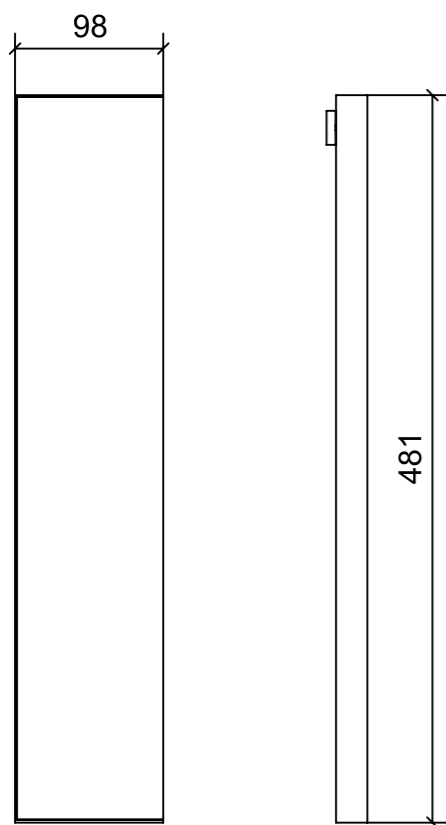

ELEMENTI DA MONTARE
in MF_CH01
e spedire con unico imballo

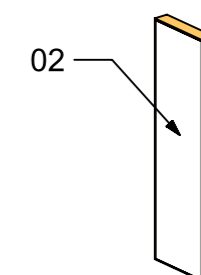

FERRAMENTA	QTY
MAGNETE FORZA MAGNETICA1-5 10KG_HAFELE_246.87.112	2

VERNICIATURA LASTRA/LACCATI:

● = VERNICIARE 1 LATO + FILI RASATI O BORDATI

NESSUN SIMBOLO = VERNICIARE 2 LATI + FILI RASATI O BORDATI