

LOCALE	CODICE	DESCRIZIONE COMPONENTE	FINITURA	GR.
TIMONERIA	MD320_R01_TA01	MOBILE QUADRI ELETTRICI	LASTRA SCURA	2

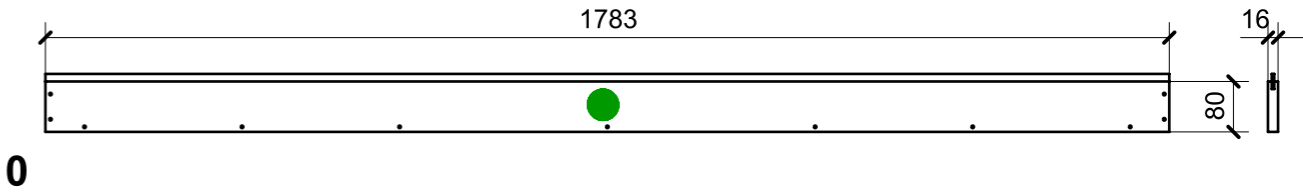

01

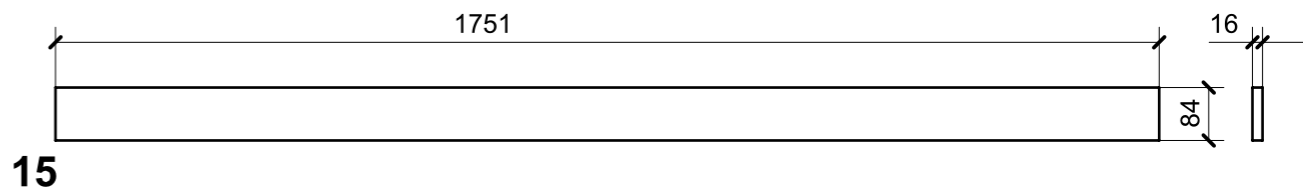
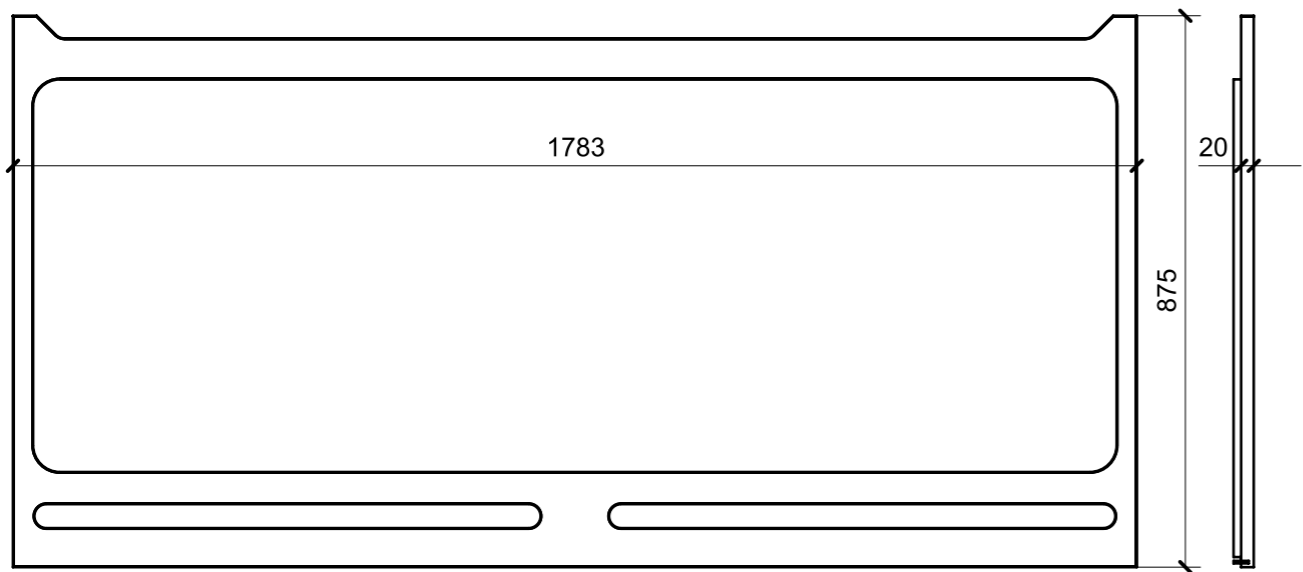
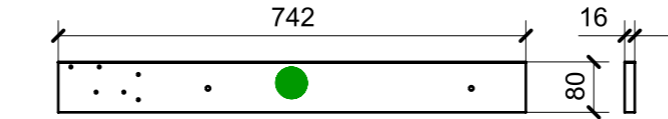
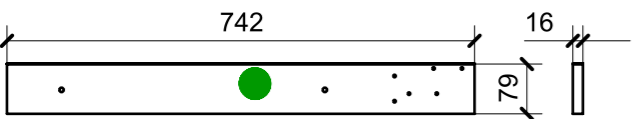

02

04

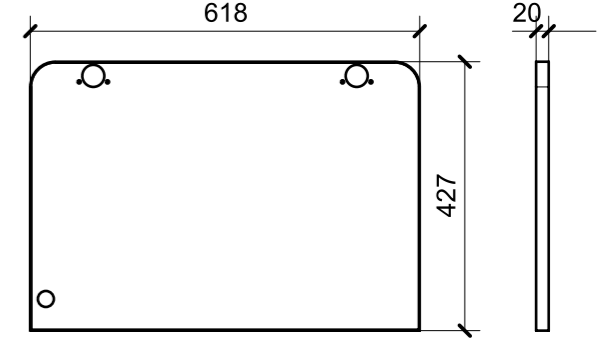
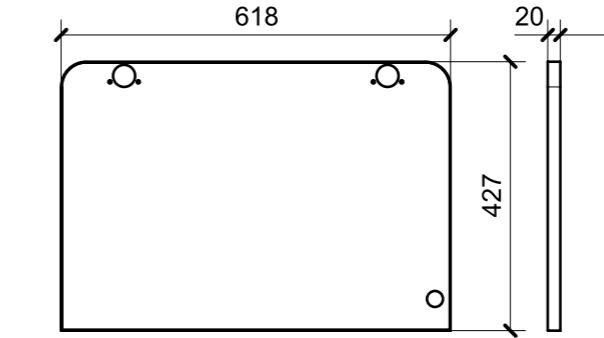

11

14

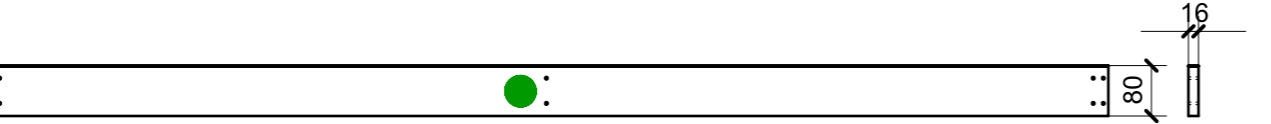

16

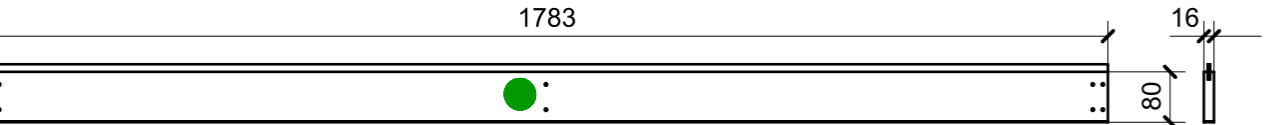

03

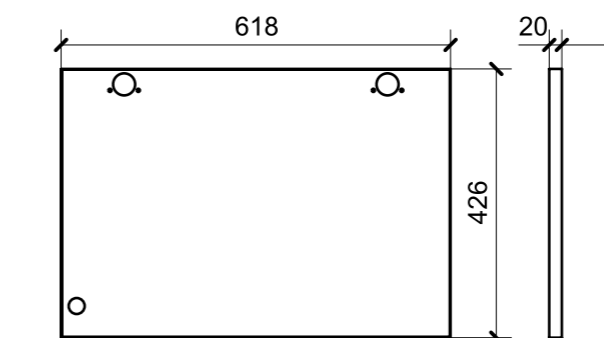

12

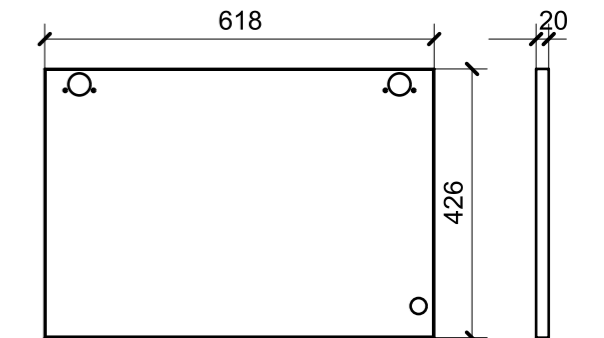

13

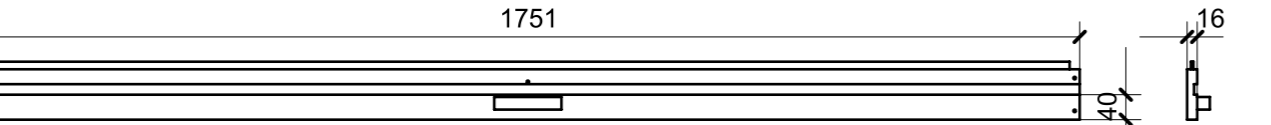

05

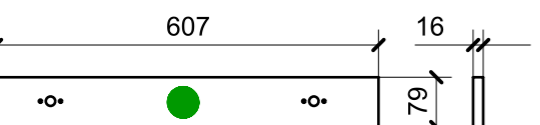

06

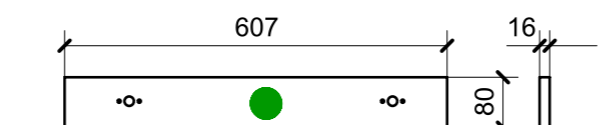

08

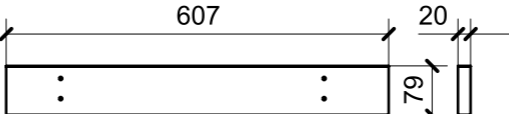

07

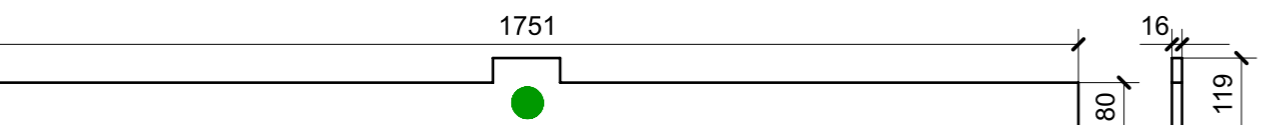

09

ELEMENTI DA MONTARE con L01\_01 in MF\_TA01 e spedire con unico imballo

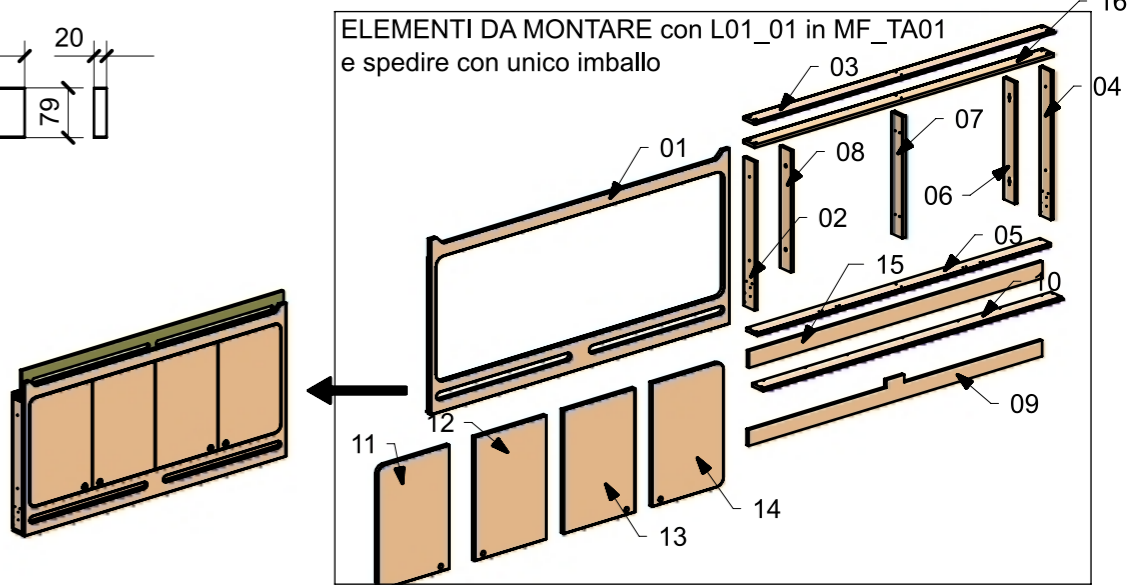

VERNICIATURA LASTRA/LACCATI:  
 ● = VERNICIARE 1 LATO + FILI RASATI O BORDATI    NESSUN SIMBOLO = VERNICIARE 2 LATI + FILI RASATI O BORDATI

LOCALE	CODICE	DESCRIZIONE COMPONENTE	FINITURA	GR.
TIMONERIA	MD320_R01_TC01	STRUTTURA SX LATERALE QUADRI	LASTRA SCURA	2

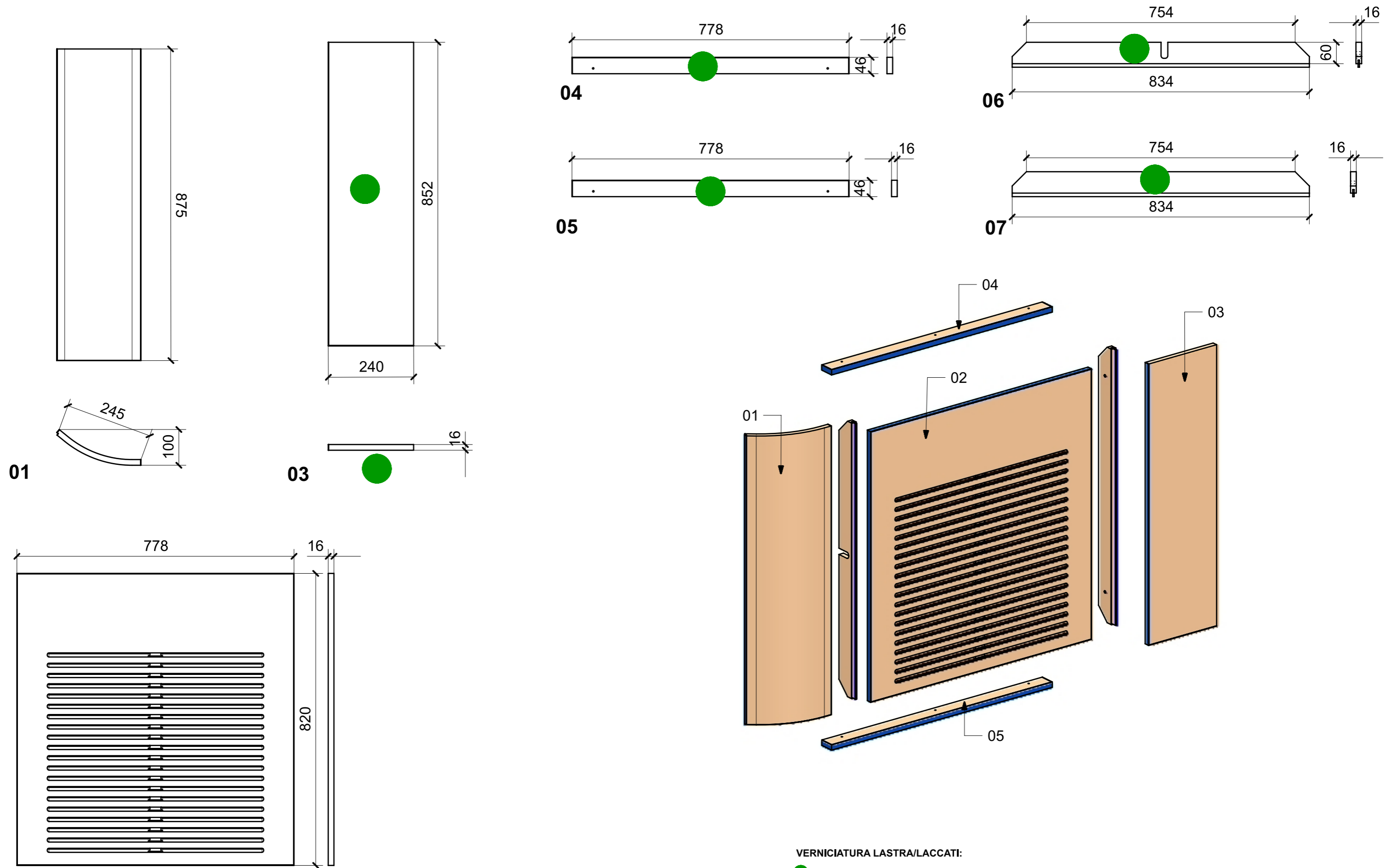

02

VERNICIATURA LASTRA/LACCATI:

● = VERNICIARE 1 LATO + FILI RASATI O BORDATI

NESSUN SIMBOLO = VERNICIARE 2 LATI + FILI RASATI O BORDATI

LOCALE	CODICE	DESCRIZIONE COMPONENTE	FINITURA	GR.
TIMONERIA	MD320_R01_TD01	STRUTTURA DX LATERALE QUADRI	LASTRA SCURA	2

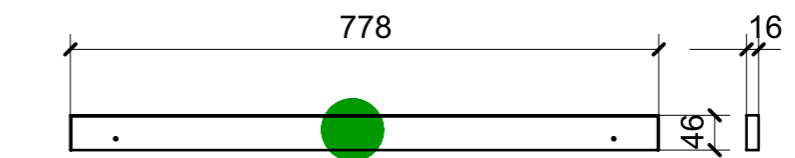
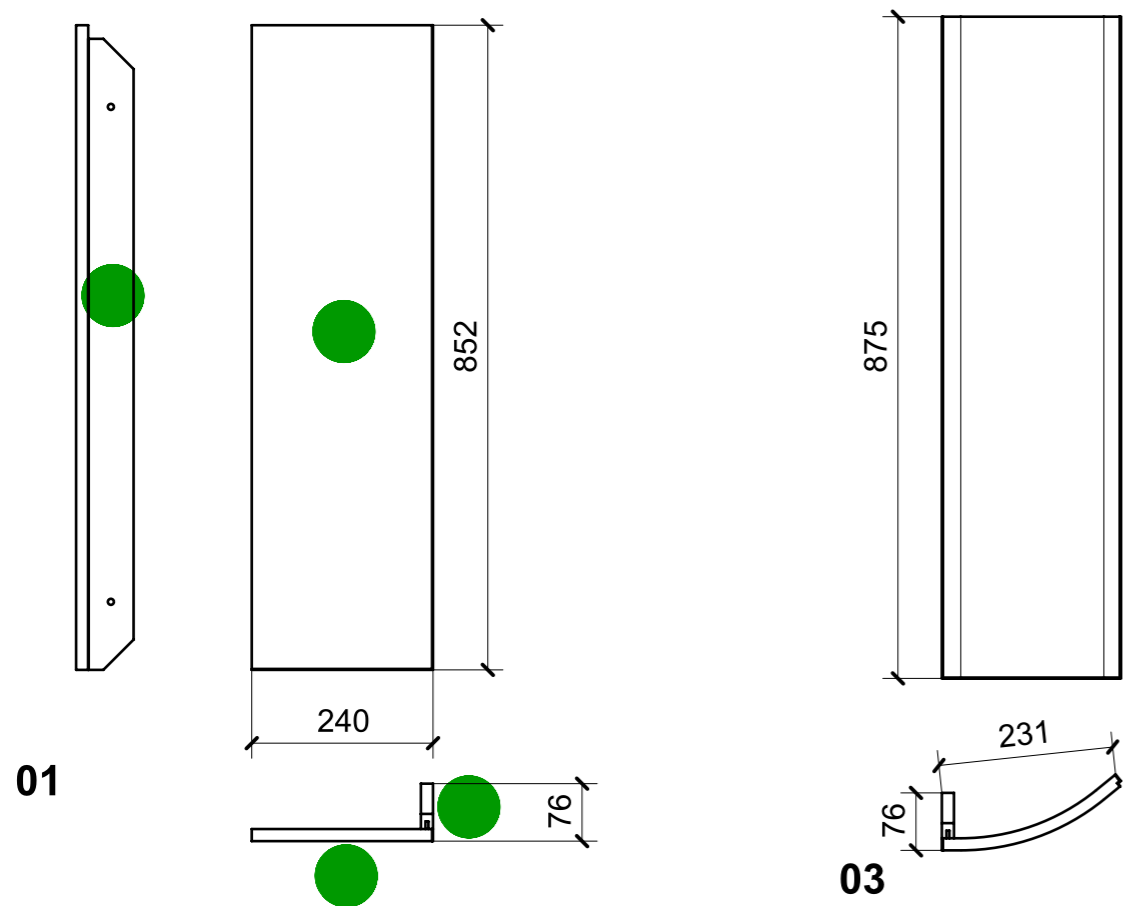

04

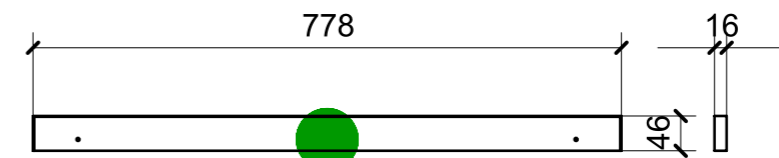

05

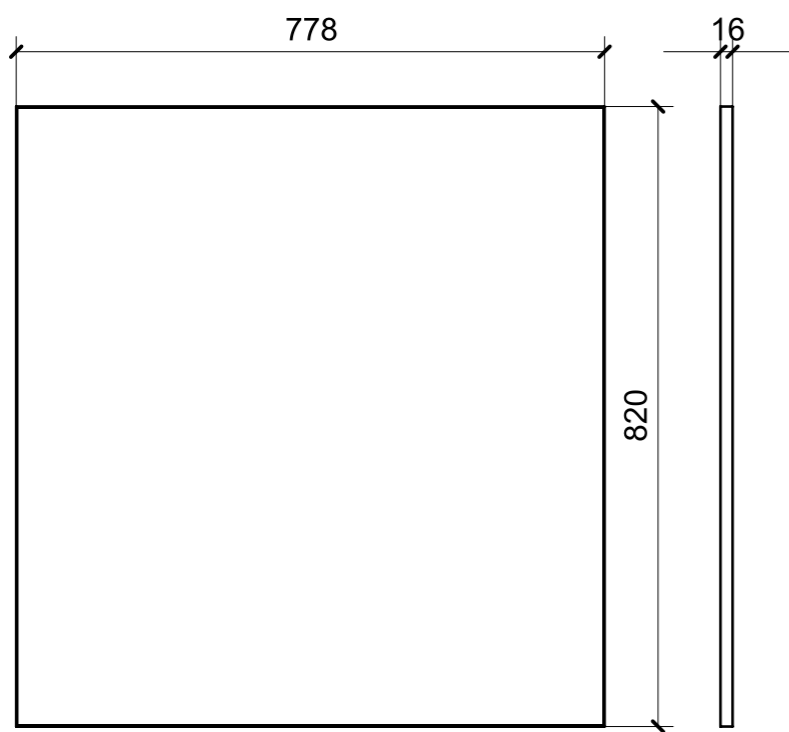
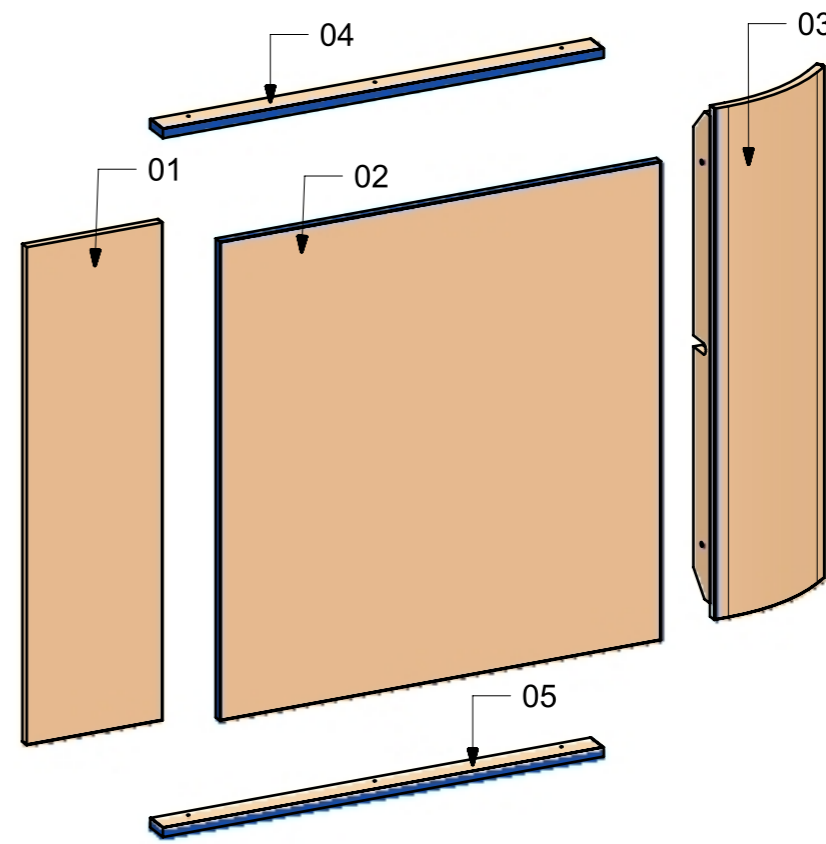

02

VERNICIATURA LASTRA/LACCATI:

● = VERNICIARE 1 LATO + FILI RASATI O BORDATI

NESSUN SIMBOLO = VERNICIARE 2 LATI + FILI RASATI O BORDATI

LOCALE	CODICE	DESCRIZIONE COMPONENTE	FINITURA	GR.
TIMONERIA	MD320_R01_TE01	STRUTTURA FRONTALE SOTTO QUADRI ELETTRICI	LASTRA SCURA	2

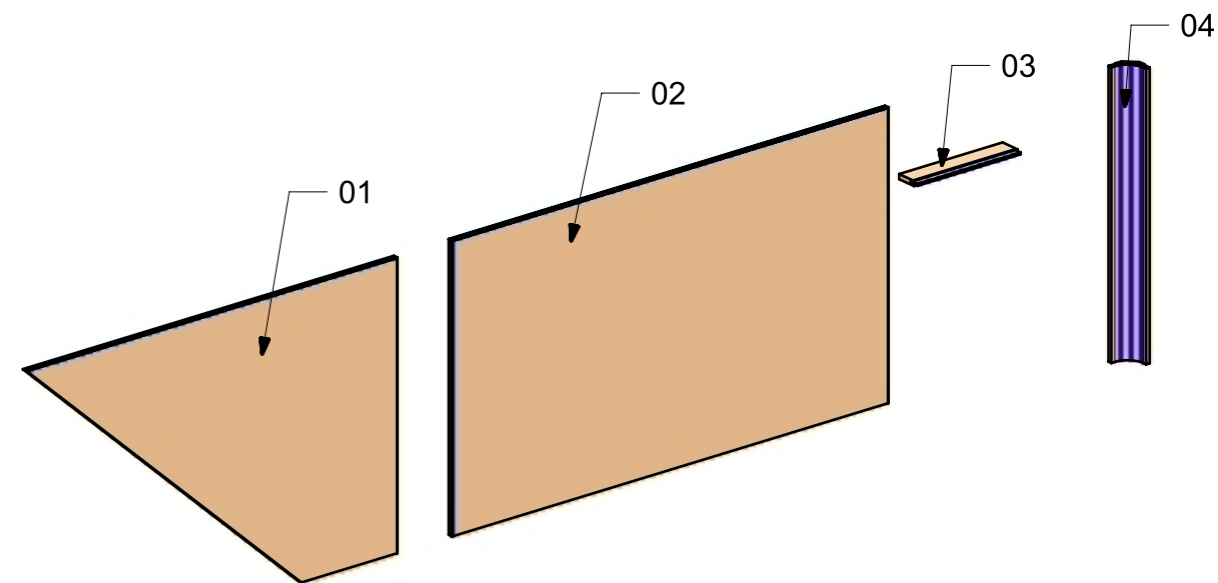
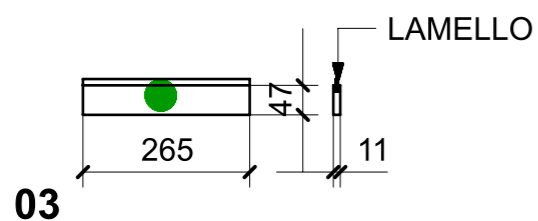
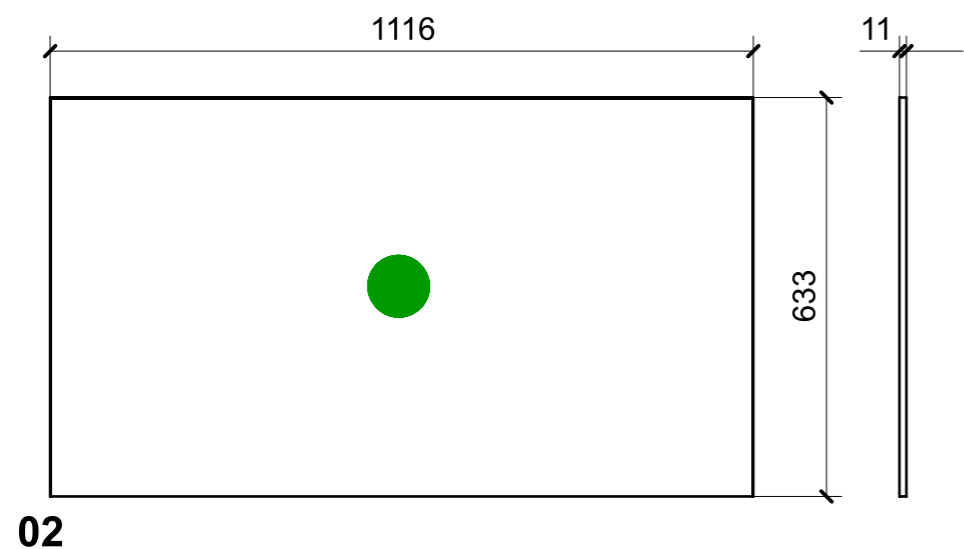
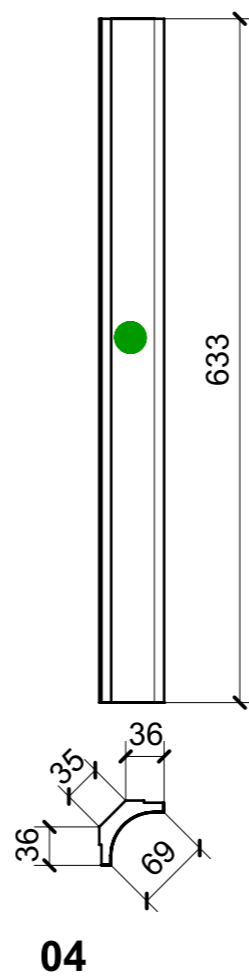
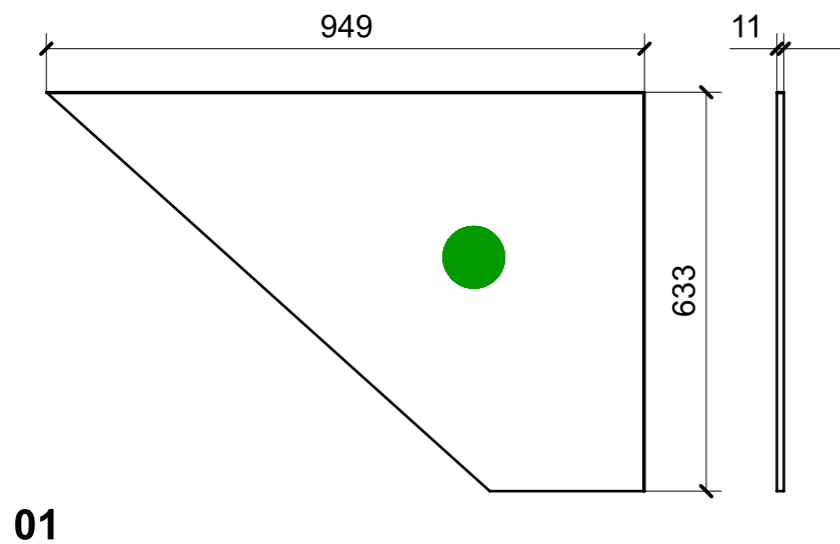

VERNICIATURA LASTRA/LACCATI:

● = VERNICIARE 1 LATO + FILI RASATI O BORDATI

NESSUN SIMBOLO = VERNICIARE 2 LATI + FILI RASATI O BORDATI

LOCALE	CODICE	DESCRIZIONE COMPONENTE	FINITURA	GR.
TIMONERIA	MD320_R02_TG01	STRUTTURA CON RIV. RETRO POLTRONE	LASTRA CHIARA	PTP

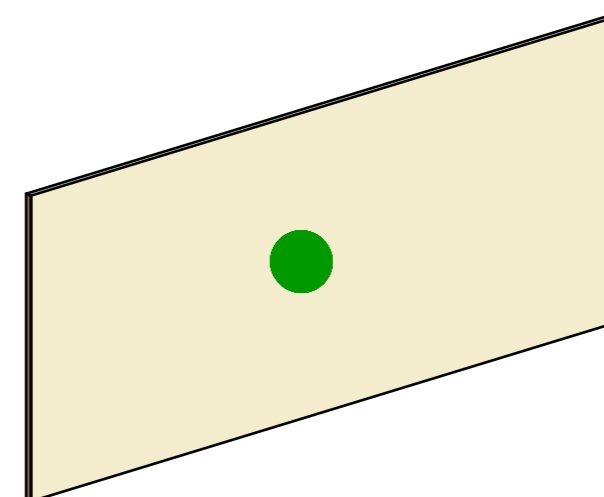
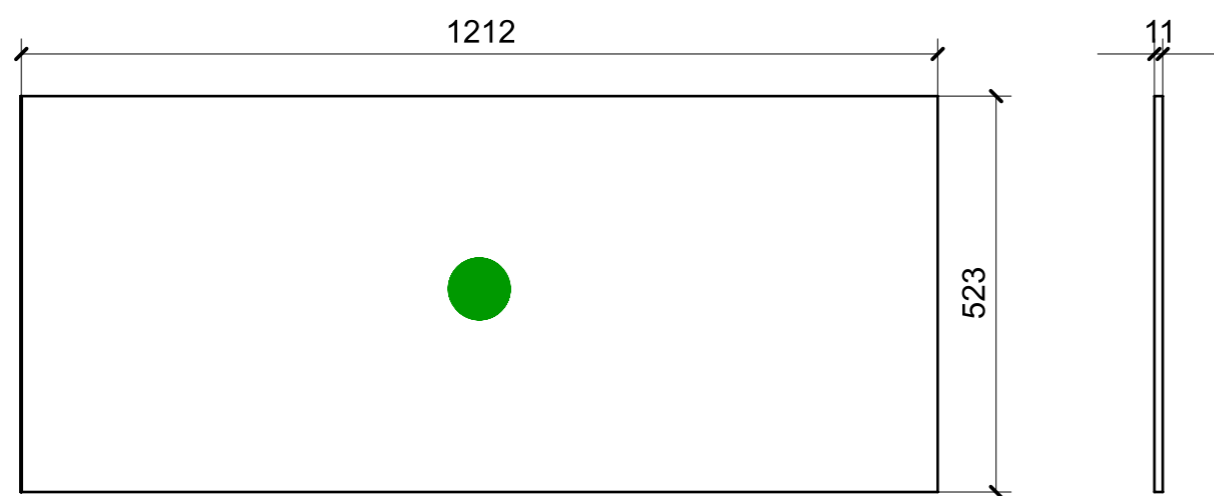

01

VERNICIATURA LASTRA/LACCATI:

● = VERNICIARE 1 LATO + FILI RASATI O BORDATI

NESSUN SIMBOLO = VERNICIARE 2 LATI + FILI RASATI O BORDATI

LOCALE	CODICE	DESCRIZIONE COMPONENTE	FINITURA	GR.
TIMONERIA	MD320_R02_TH01	STRUTTURA A L PARETE CENTRONAVE	LASTRA CHIARA	PTP

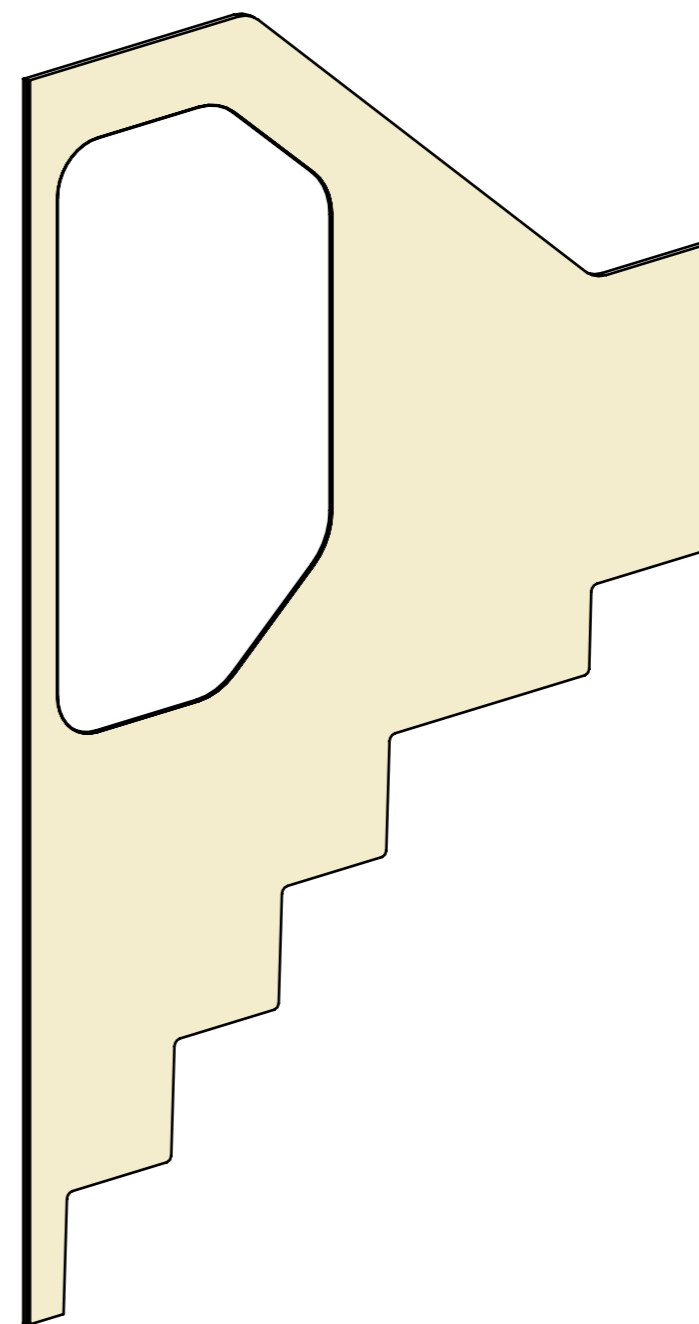
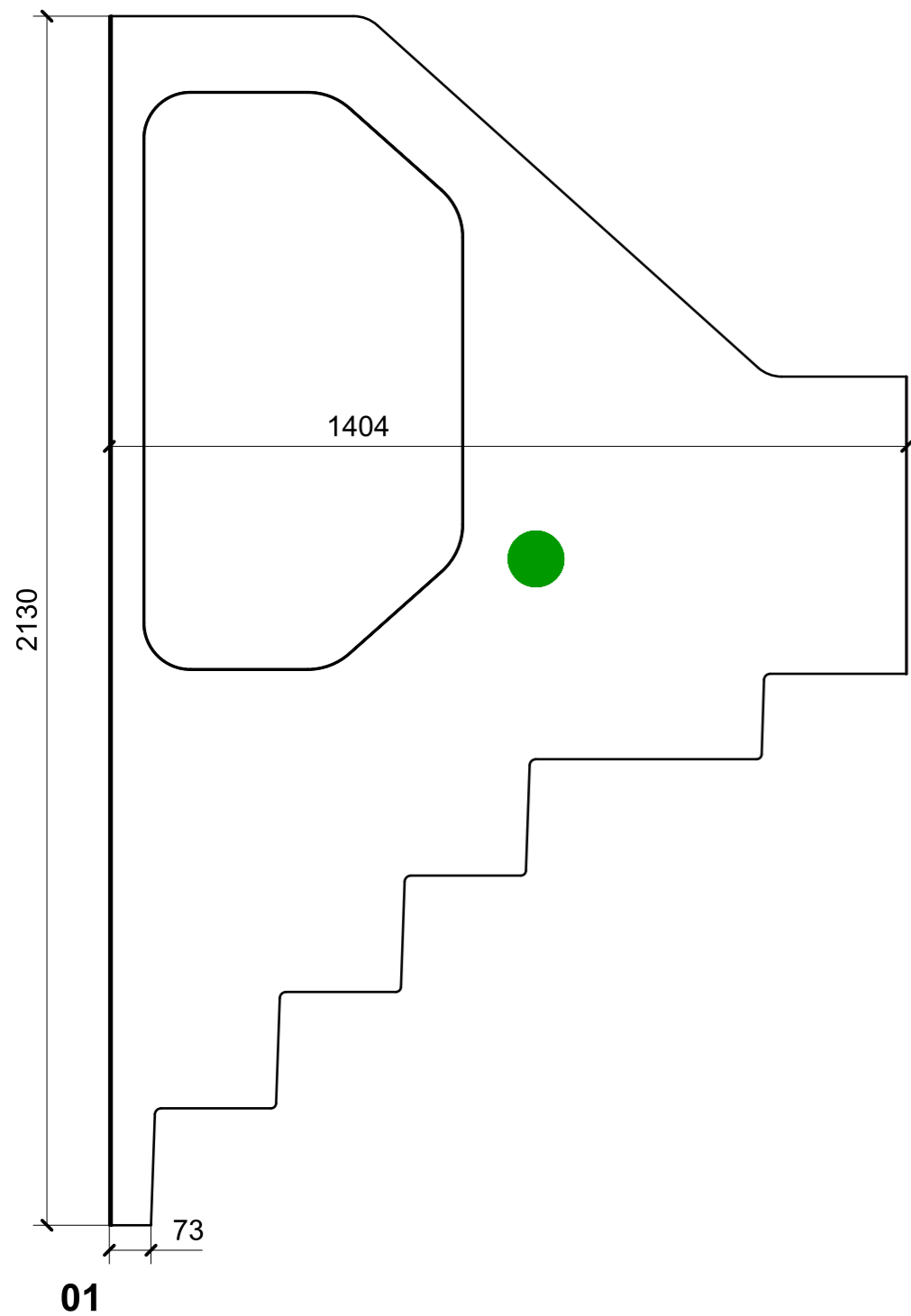

VERNICIATURA LASTRA/LACCATI:

● = VERNICIARE 1 LATO + FILI RASATI O BORDATI

NESSUN SIMBOLO = VERNICIARE 2 LATI + FILI RASATI O BORDATI

LOCALE	CODICE	DESCRIZIONE COMPONENTE	FINITURA	GR.
TIMONERIA	MD320_R02_TM01	STRUTTURA CIELINO DX	LASTRA CHIARA	2

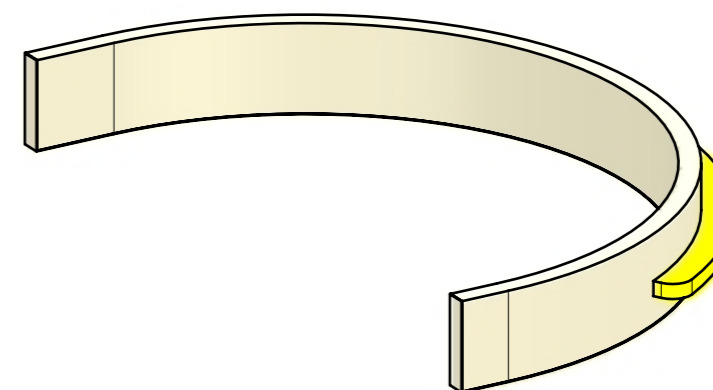
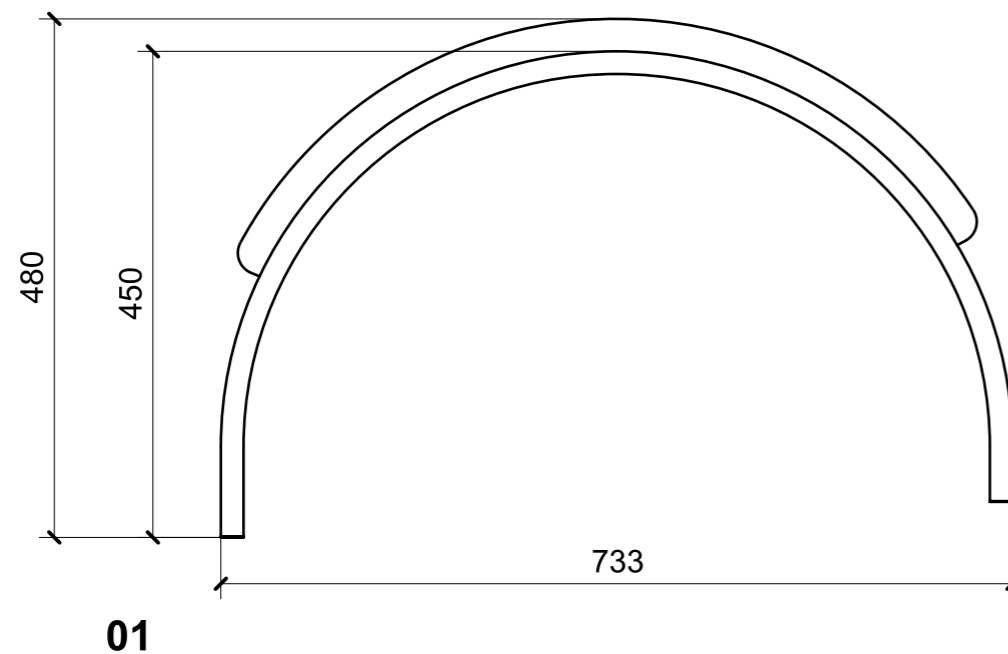
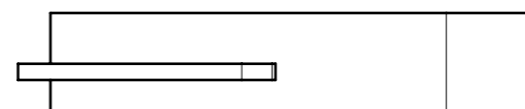
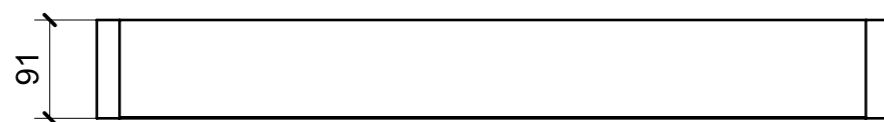

VERNICIATURA LASTRA/LACCATI:

● = VERNICIARE 1 LATO + FILI RASATI O BORDATI

NESSUN SIMBOLO = VERNICIARE 2 LATI + FILI RASATI O BORDATI

LOCALE	CODICE	DESCRIZIONE COMPONENTE	FINITURA	GR.
TIMONERIA	MD320_R01_TN01	RIV. PARETE TIENTIBENE	LASTRA CHIARA	2

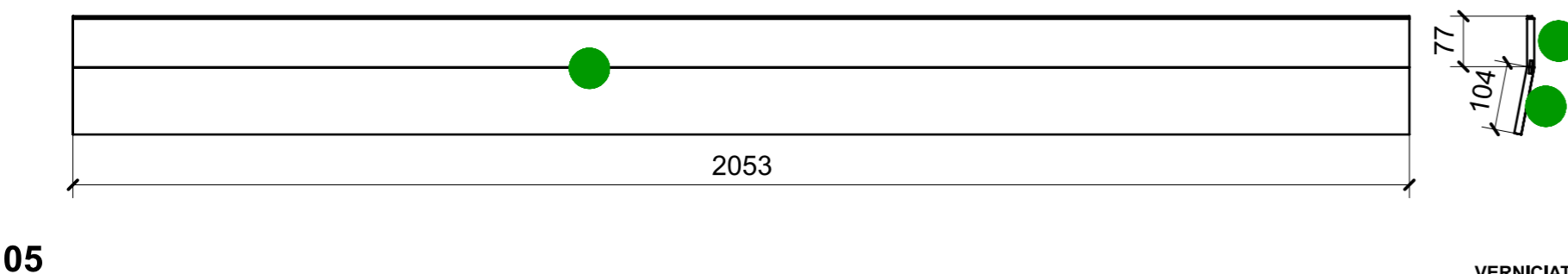
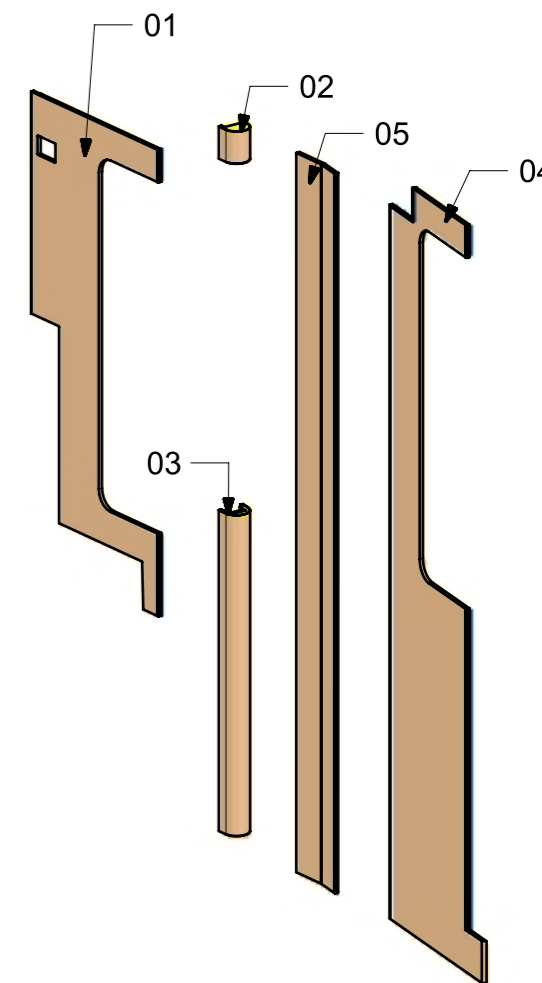
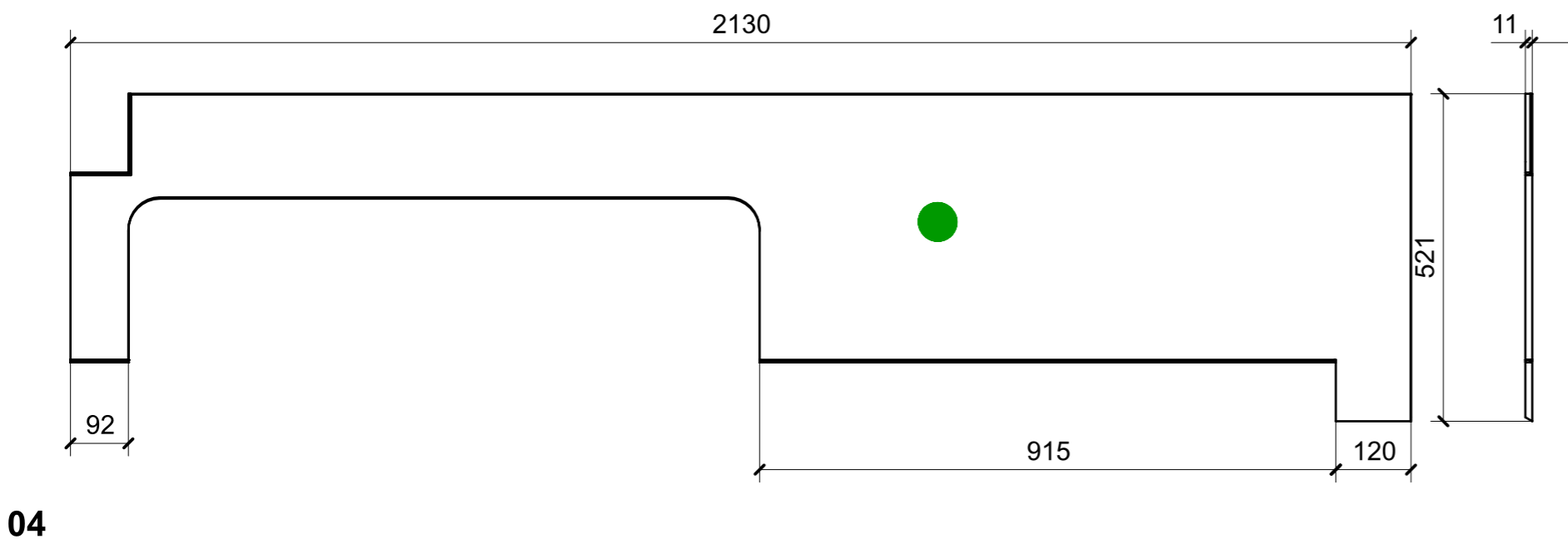
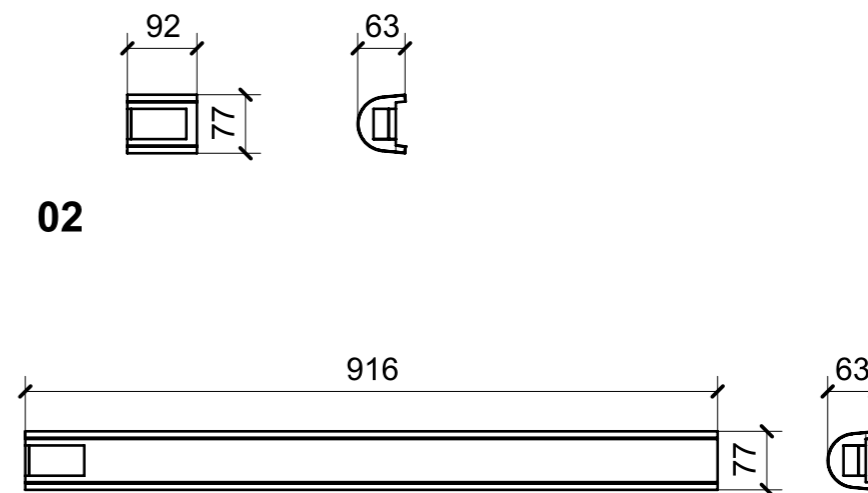
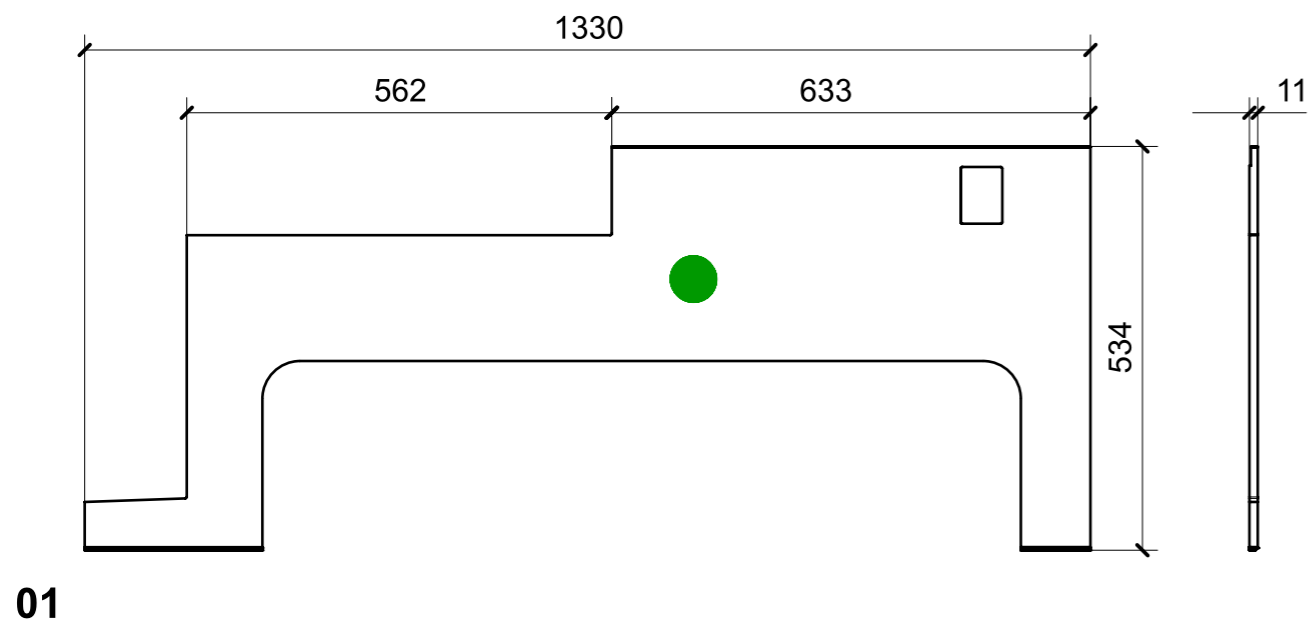

VERNICIATURA LASTRA/LACCATI:

● = VERNICIARE 1 LATO + FILI RASATI O BORDATI

NESSUN SIMBOLO = VERNICIARE 2 LATI + FILI RASATI O BORDATI

LOCALE	CODICE	DESCRIZIONE COMPONENTE	FINITURA	GR.
TIMONERIA	MD320_R01_TO01	STRUTTURA CIELINO SX	LASTRA SCURA	2

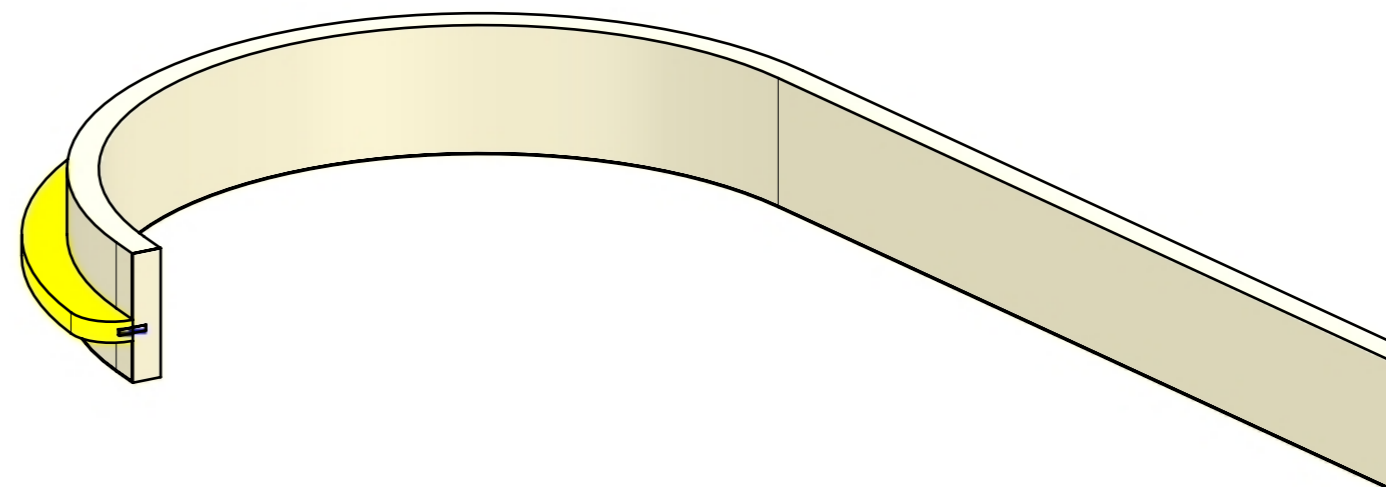
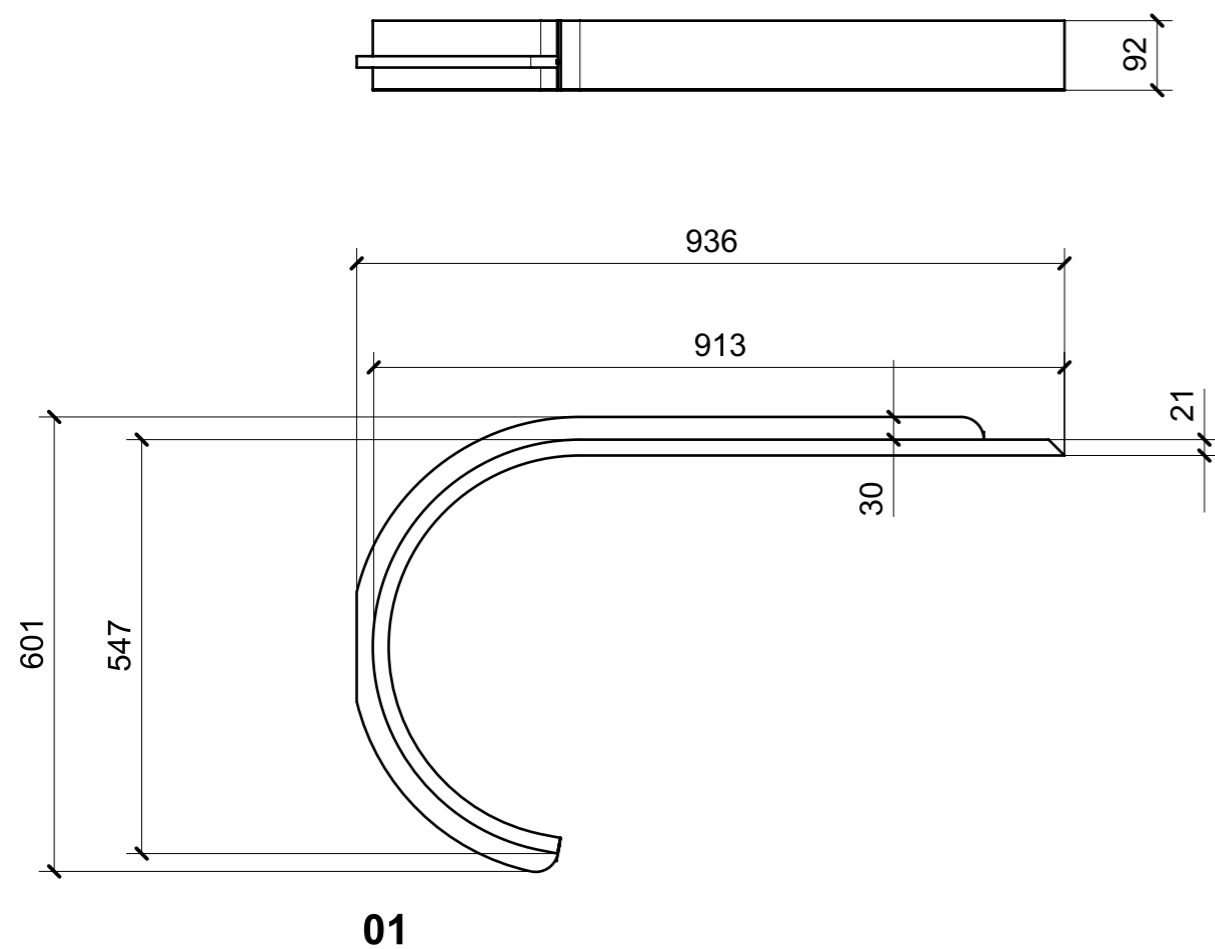

VERNICIATURA LASTRA/LACCATI:

● = VERNICIARE 1 LATO + FILI RASATI O BORDATI

NESSUN SIMBOLO = VERNICIARE 2 LATI + FILI RASATI O BORDATI

LOCALE	CODICE	DESCRIZIONE COMPONENTE	FINITURA	GR.
TIMONERIA	MD320_R02_TR01	RIV. DISCESA SCALE LATO MARINAIO	LASTRA CHIARA	PTP

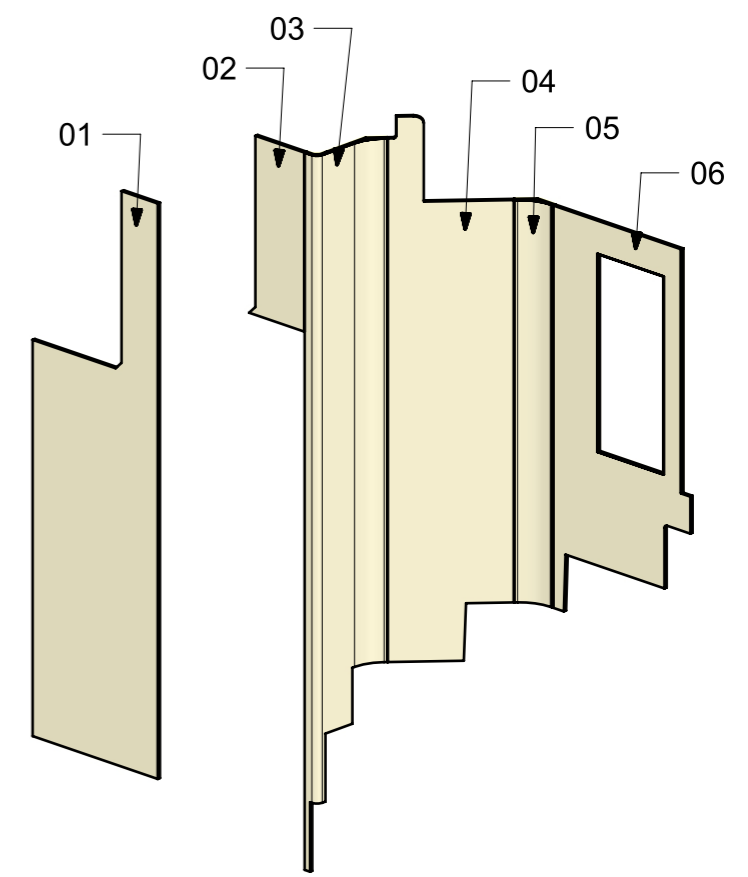
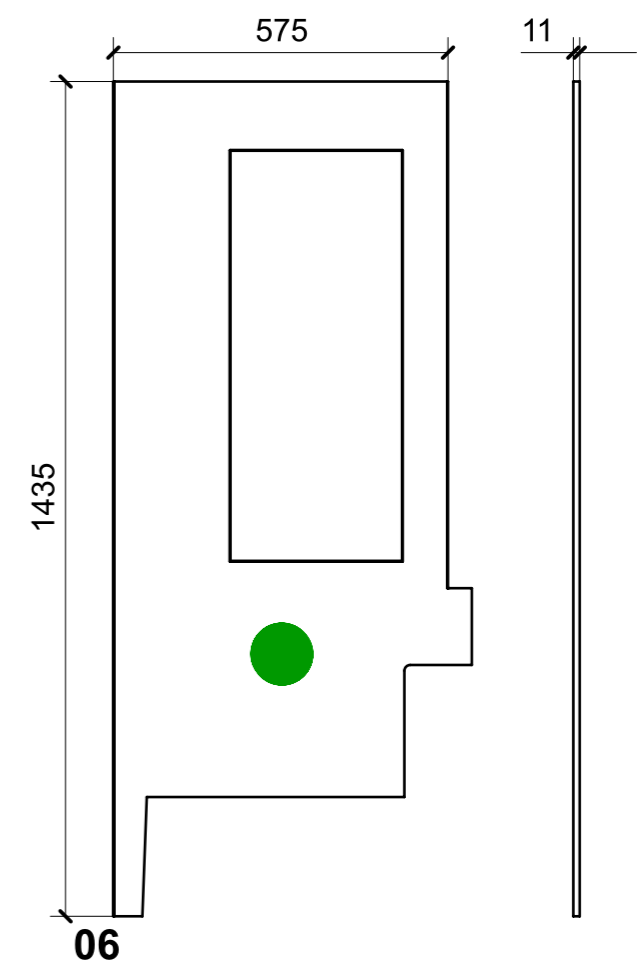
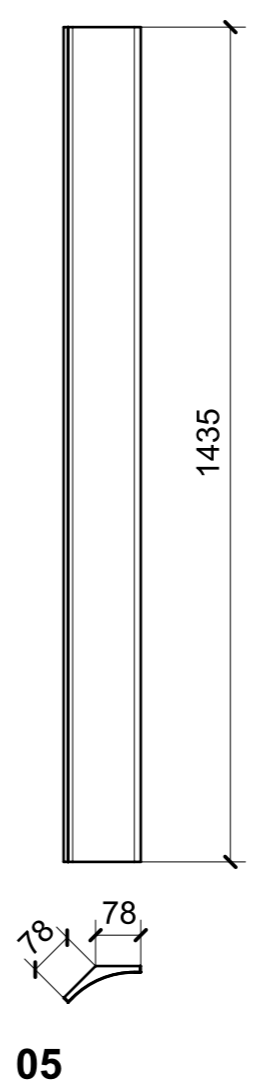
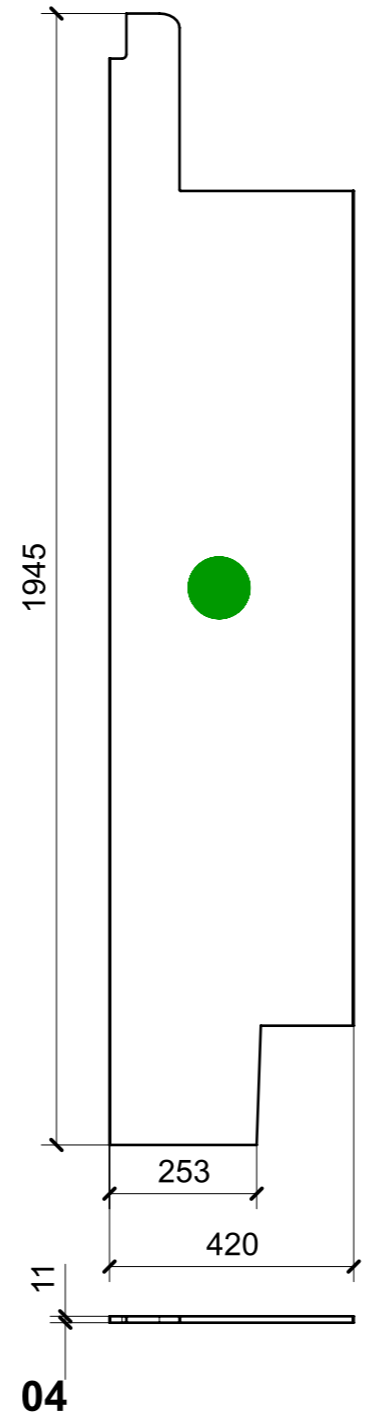
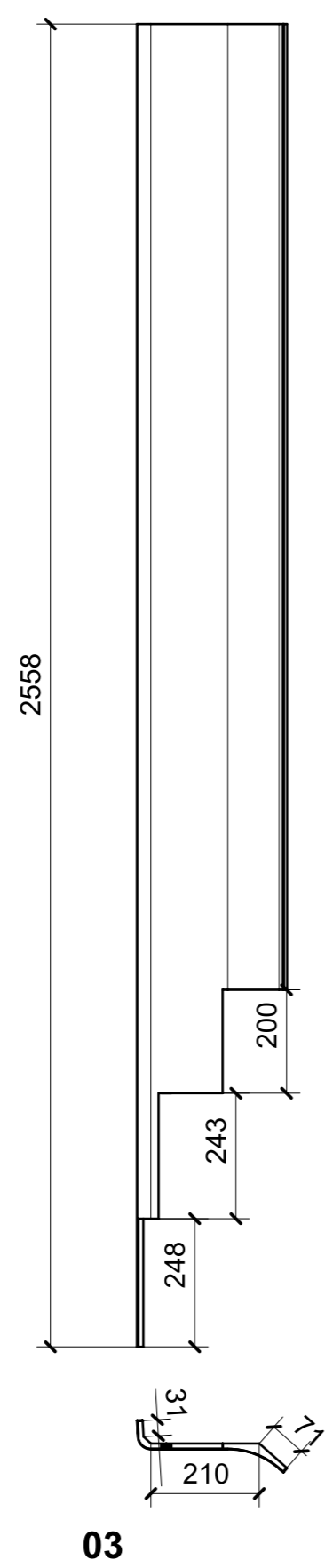
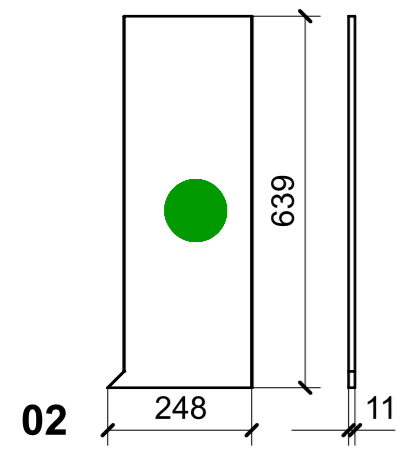
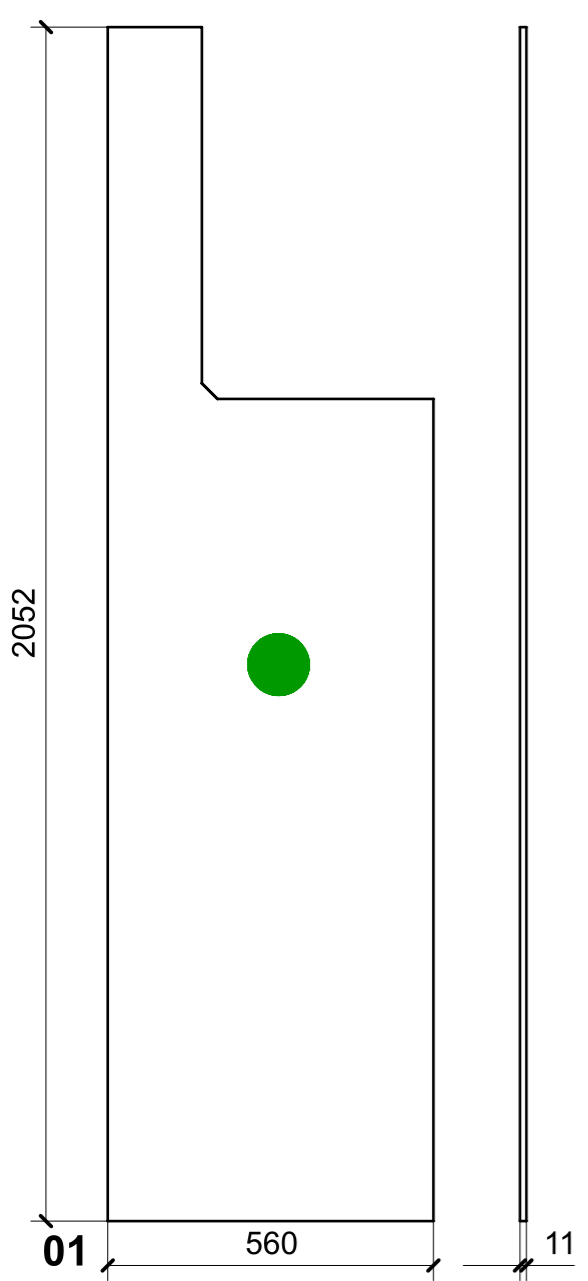

VERNICIATURA LASTRA/LACCATI:  
 ● = VERNICIARE 1 LATO + FILI RASATI O BORDATI  
 NESSUN SIMBOLO = VERNICIARE 2 LATI + FILI RASATI O BORDATI

LOCALE	CODICE	DESCRIZIONE COMPONENTE	FINITURA	GR.
TIMONERIA	MD320_R02_TS01	PARETE OBLO'	LAISTRA CHIARA/LAISTRA SCURA	2

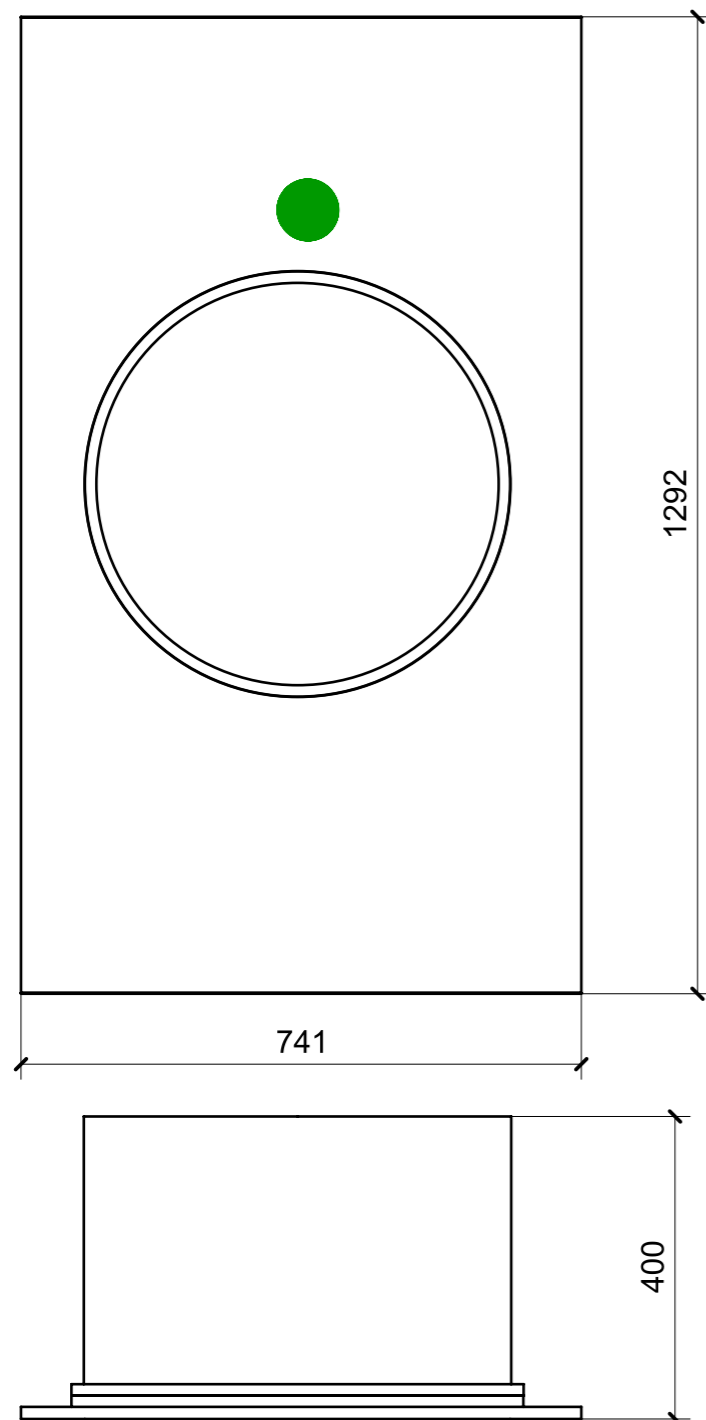

01

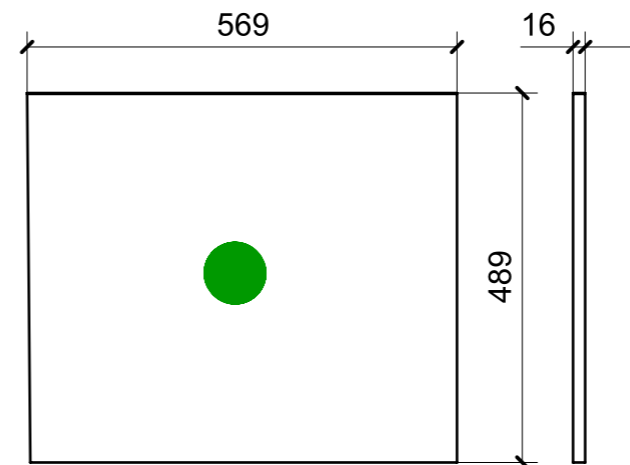

02

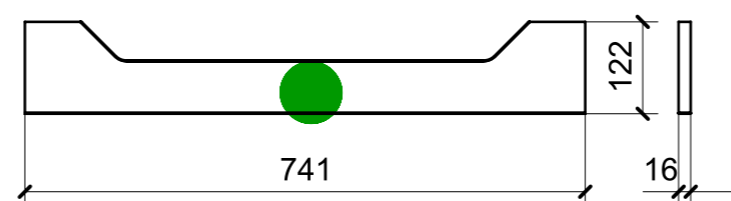

03

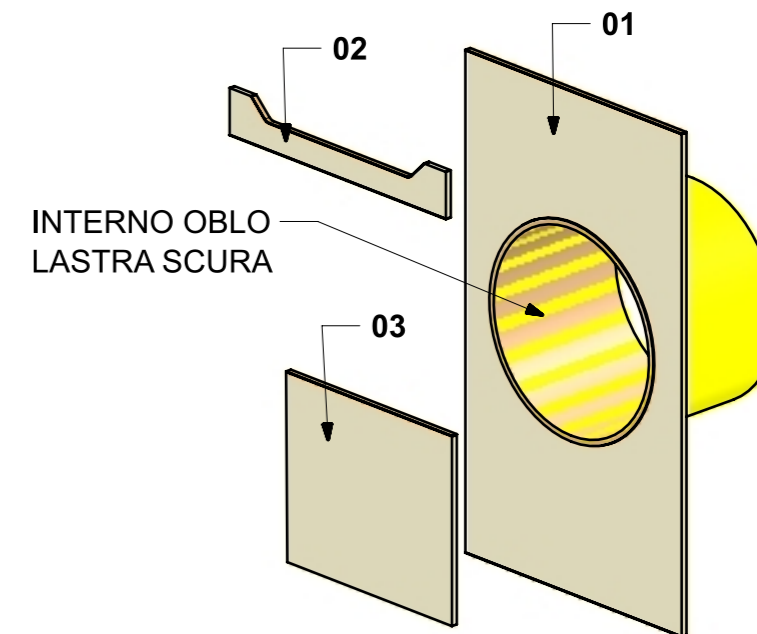

FERRAMENTA	QTY
BUSSOLA 6MA X 10 FORO DIAM.8	3

VERNICIATURA LAISTRA/LACCATI:

● = VERNICIARE 1 LATO + FILI RASATI O BORDATI

NESSUN SIMBOLO = VERNICIARE 2 LATI + FILI RASATI O BORDATI

LOCALE	CODICE	DESCRIZIONE COMPONENTE	FINITURA	GR.
TIMONERIA	MD320_R02_TU01	BLOCCO CENTRALE CRUSCOTTO TIMONERIA	LASTRA CHIARA	PTP

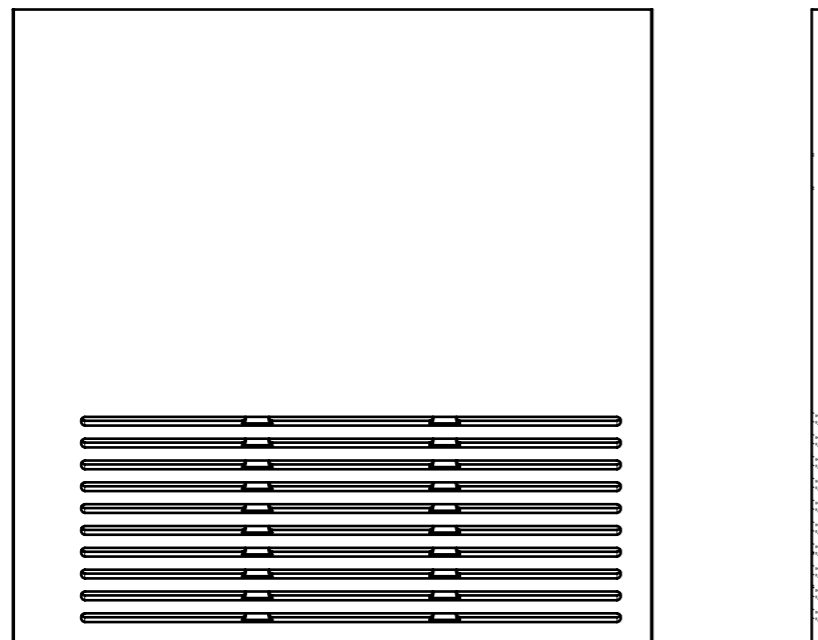

01

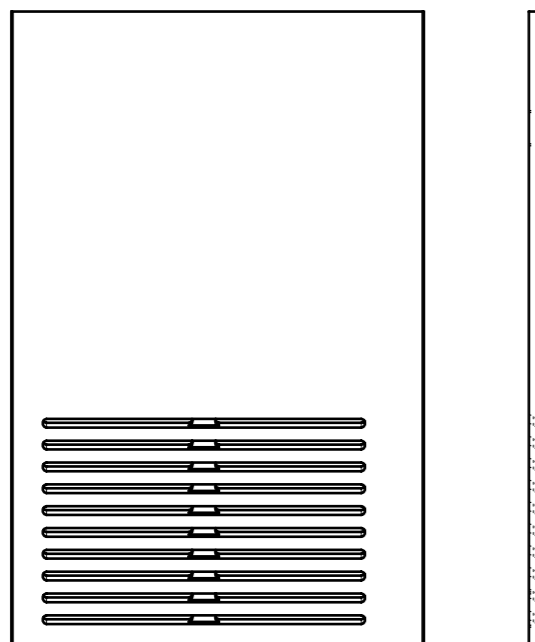

02

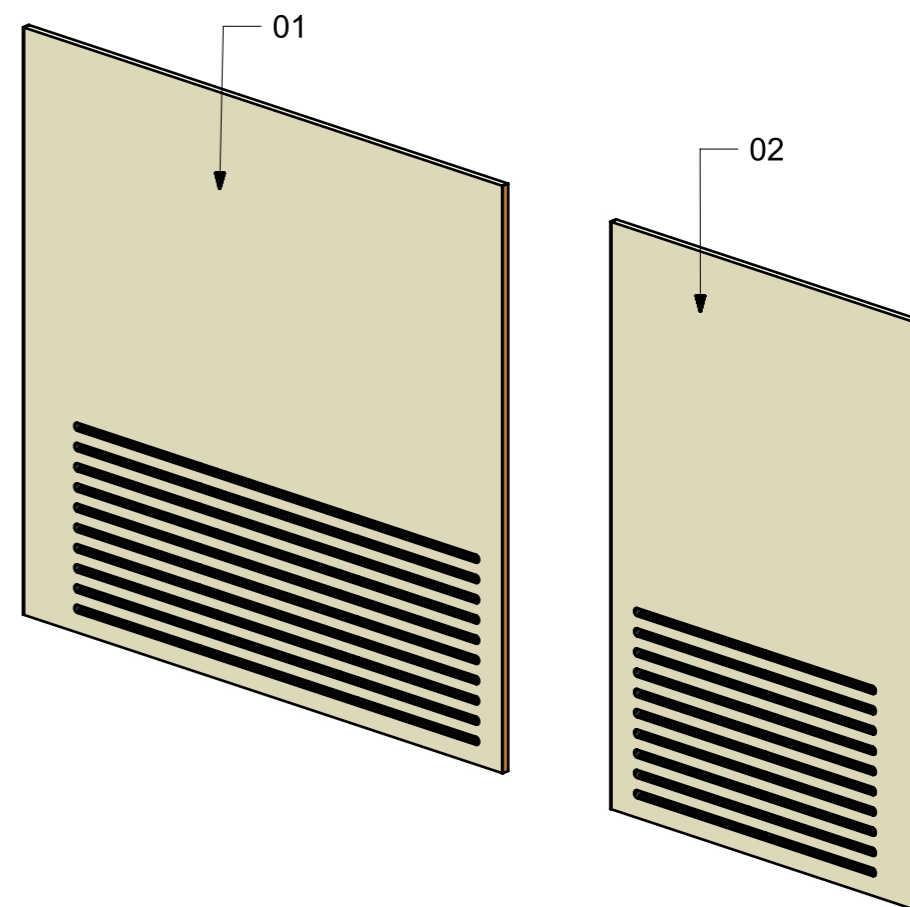

VERNICIATURA LASTRA/LACCATI:

● = VERNICIARE 1 LATO + FILI RASATI O BORDATI

NESSUN SIMBOLO = VERNICIARE 2 LATI + FILI RASATI O BORDATI

LOCALE	CODICE	DESCRIZIONE COMPONENTE	FINITURA	GR.
TIMONERIA	MD320_R02_TV01	RIV. DISCESA SCALE LATO ARMATORE	LASTRA CHIARA	PTP

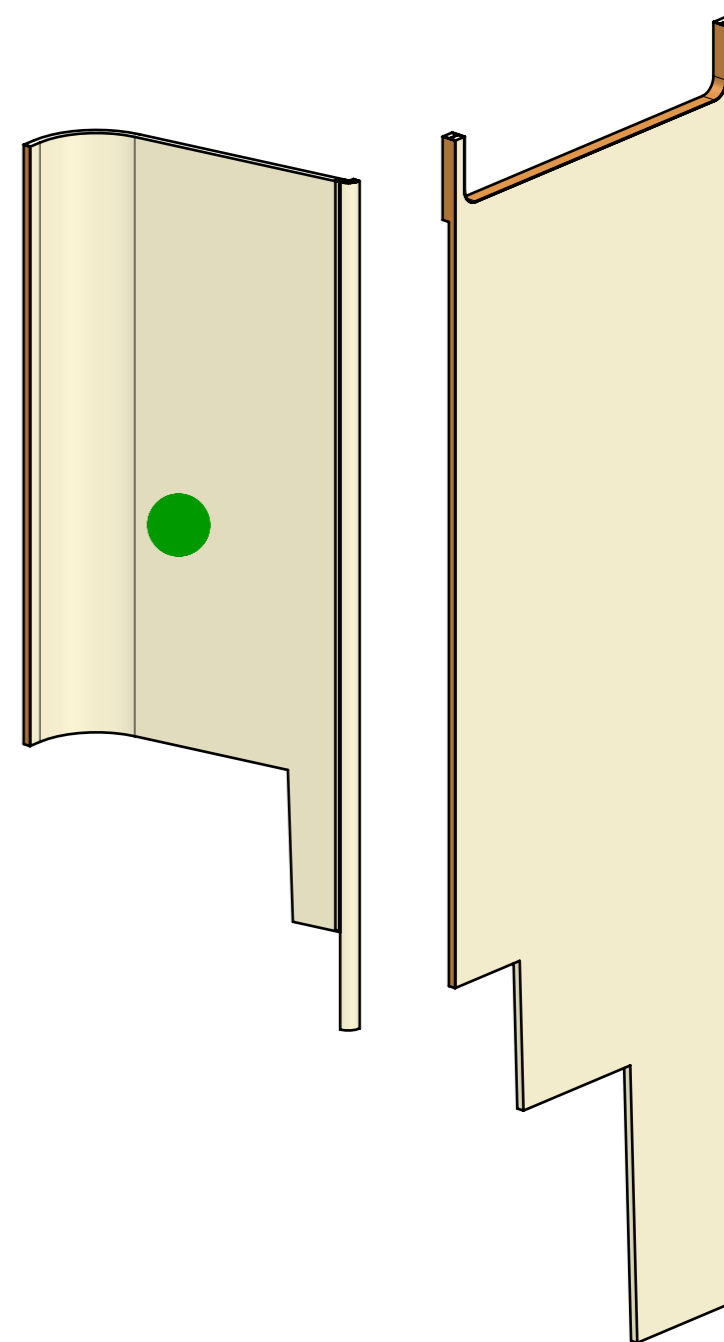
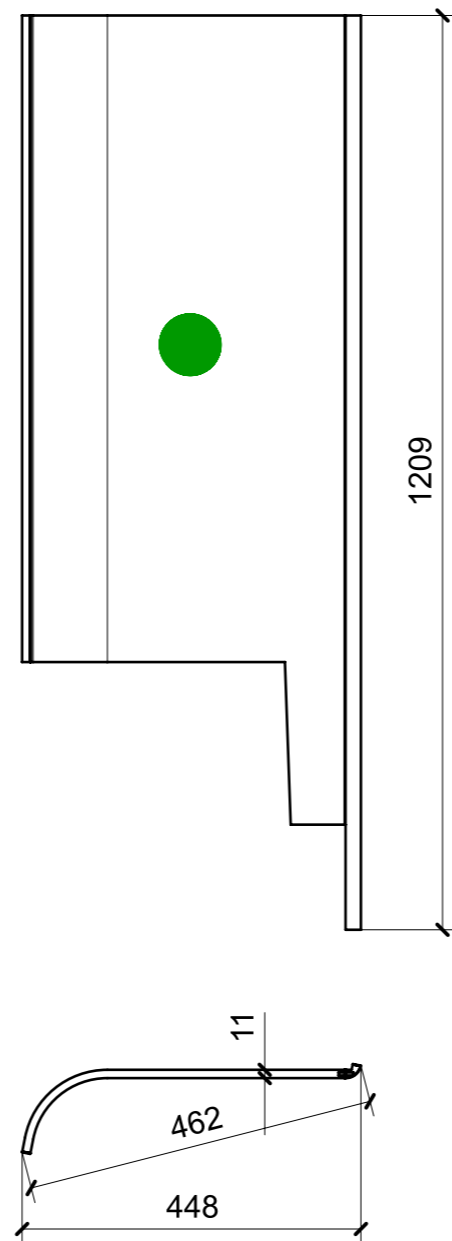
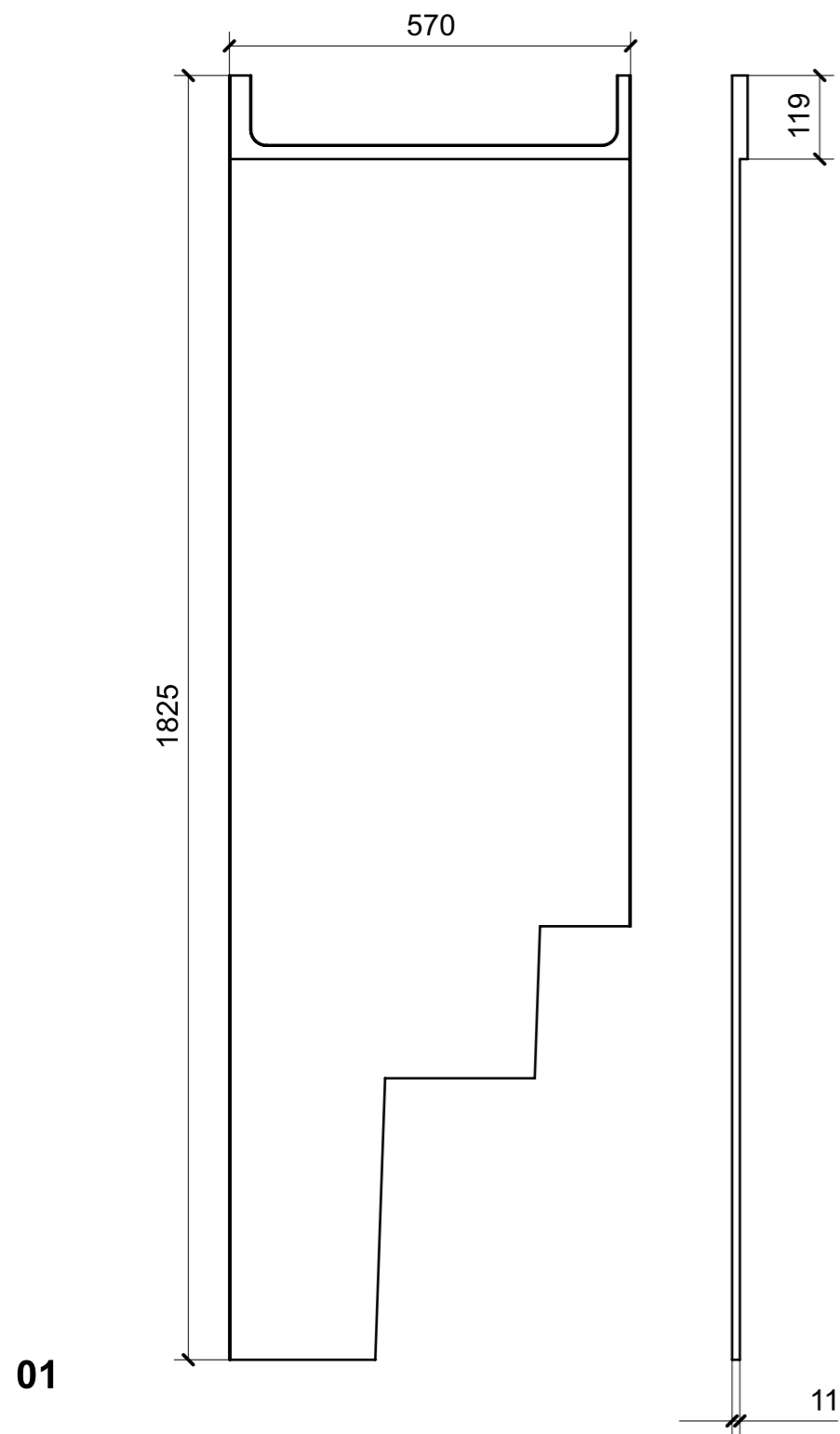

VERNICIATURA LASTRA/LACCATI:

● = VERNICIARE 1 LATO + FILI RASATI O BORDATI

NESSUN SIMBOLO = VERNICIARE 2 LATI + FILI RASATI O BORDATI

LOCALE	CODICE	DESCRIZIONE COMPONENTE	FINITURA	GR.
TIMONERIA	MD320_R02_TX01	RIV. GRADINI DISCESA MARINAIO	LASTRA SCURA	2

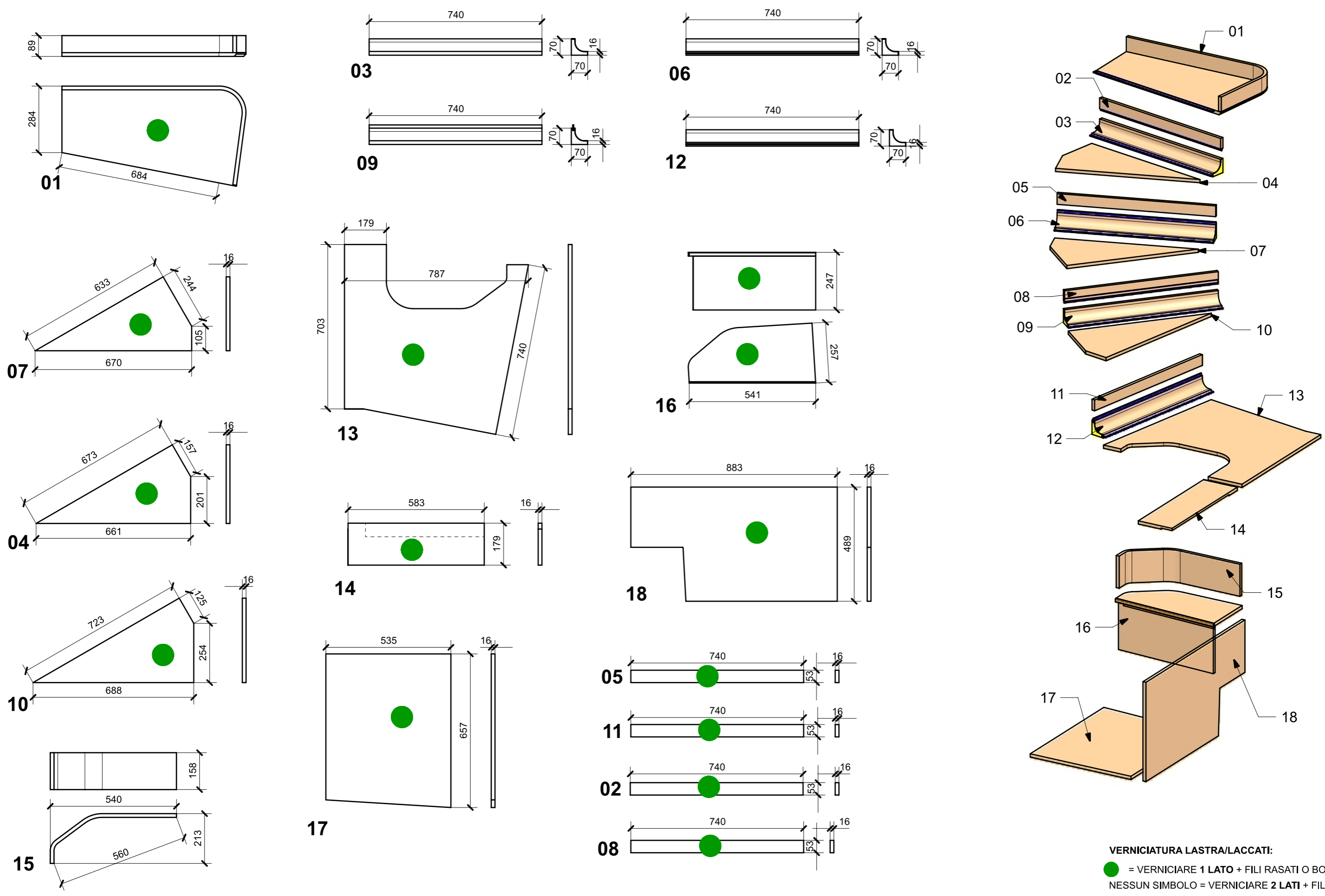

LOCALE	CODICE	DESCRIZIONE COMPONENTE	FINITURA	GR.
TIMONERIA	MD320_R02_TX01	RIV. GRADINI DISCESA MARINAIO	LASTRA CHIARA	2

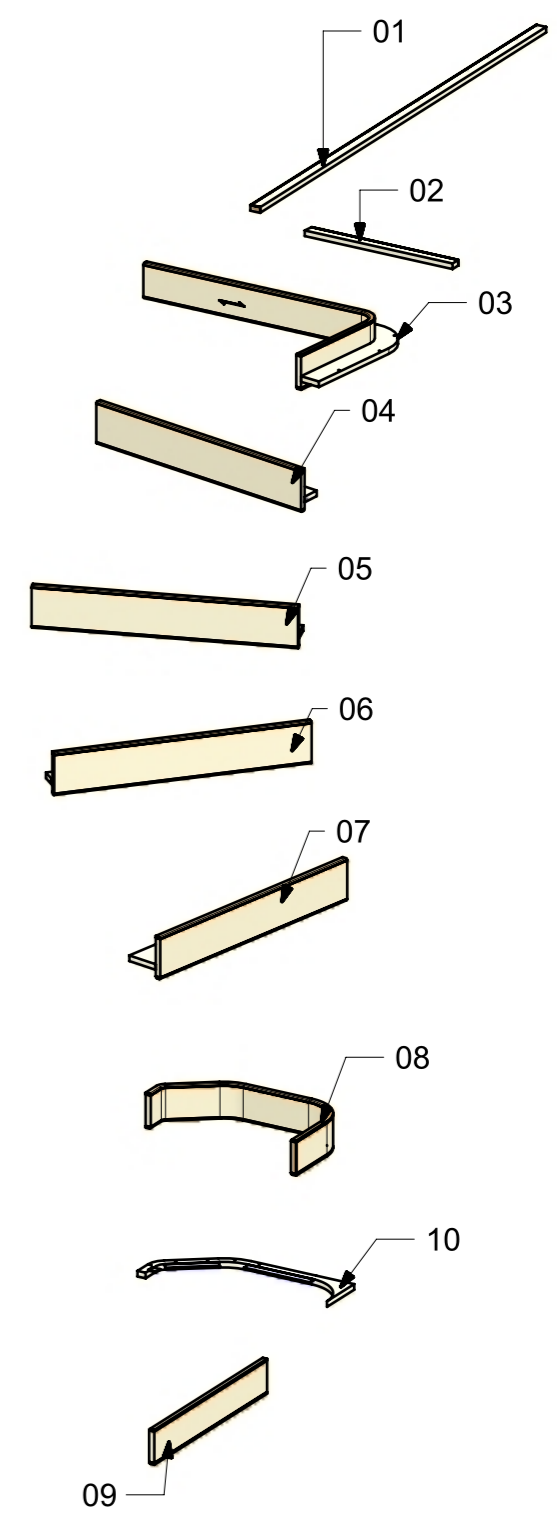
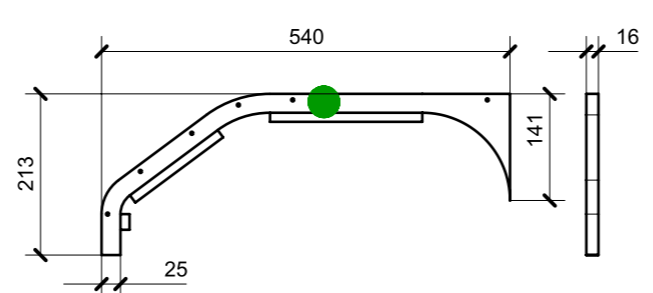
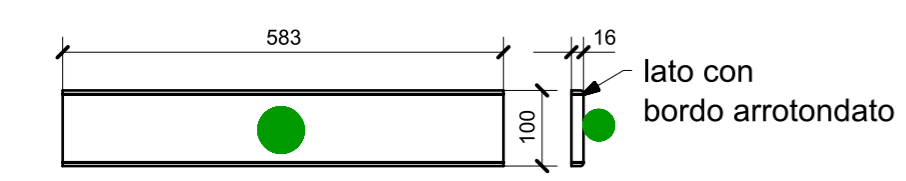
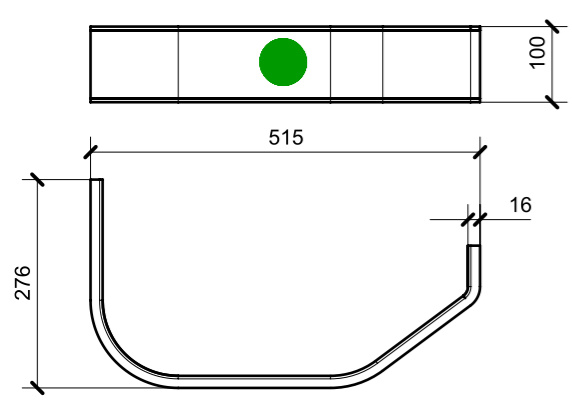
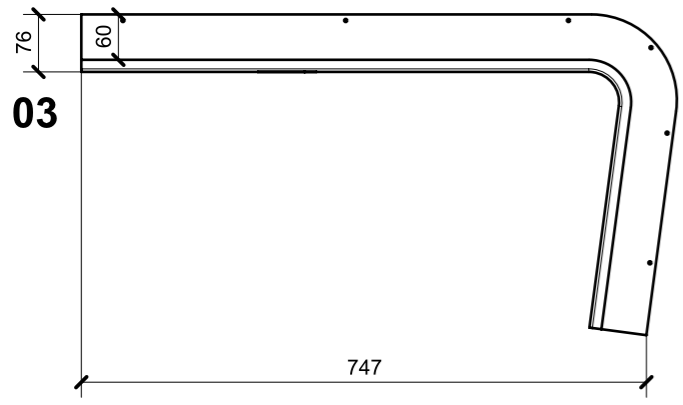
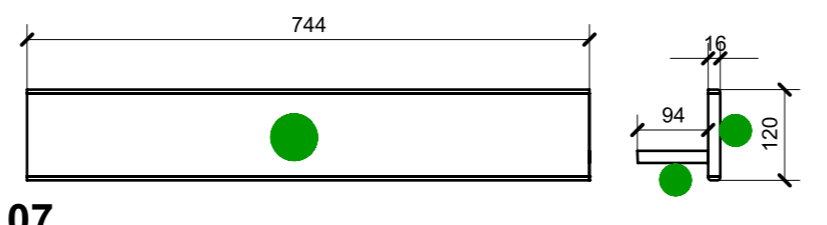
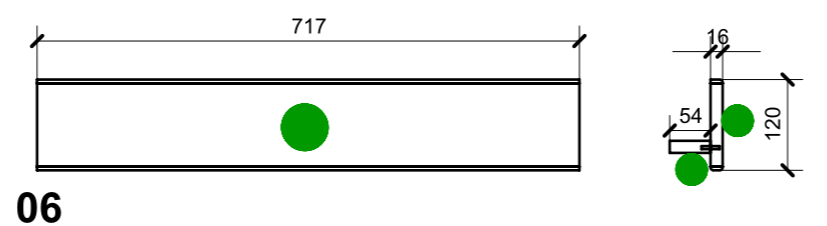
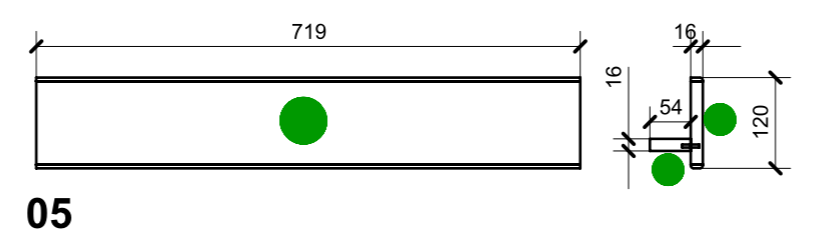
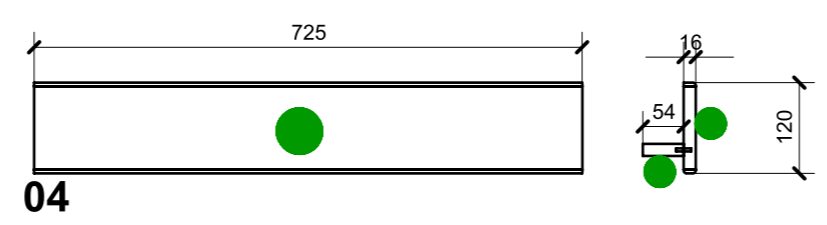
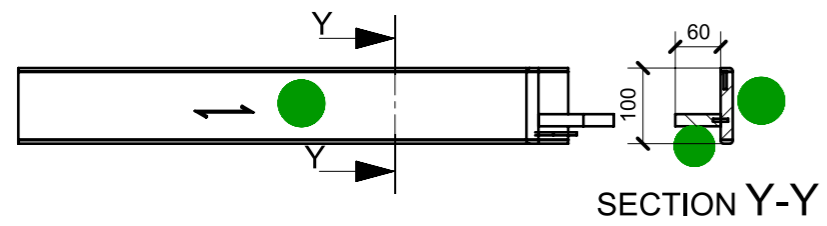
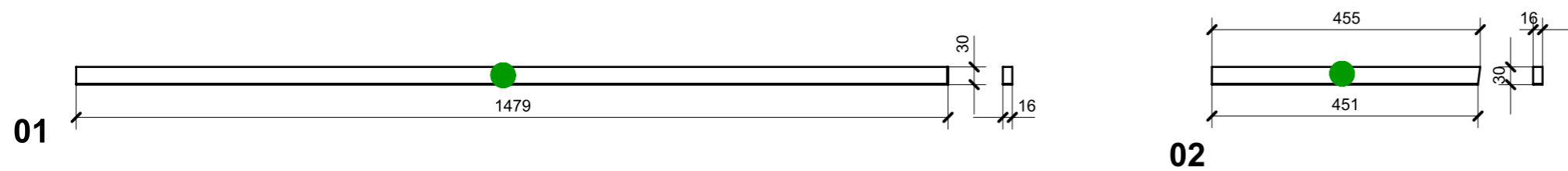

VERNICIATURA LASTRA/LACCATI:  
 ● = VERNICIARE 1 LATO + FILI RASATI O BORDATI  
 NESSUN SIMBOLO = VERNICIARE 2 LATI + FILI RASATI O BORDATI

LOCALE	CODICE	DESCRIZIONE COMPONENTE	FINITURA	GR.
TIMONERIA	MD320_R01_TY01	RIV. GRADINI DISCESA ARMATORE	LASTRA SCURA	2

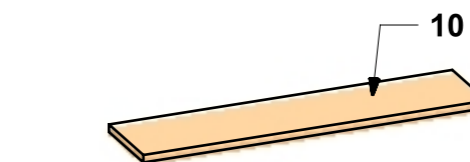
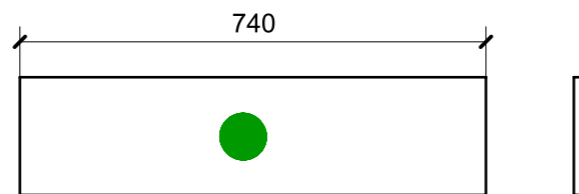
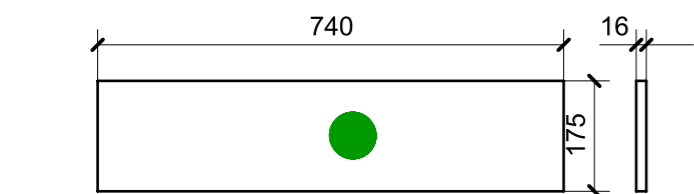
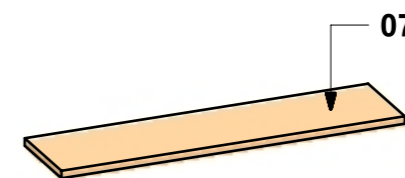
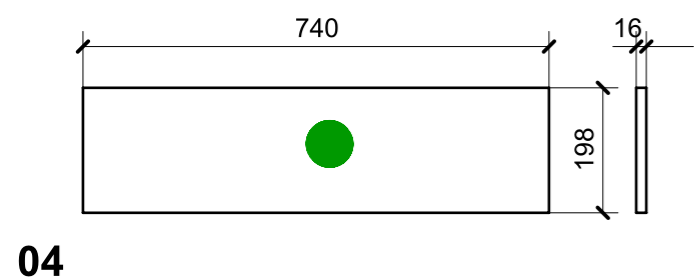
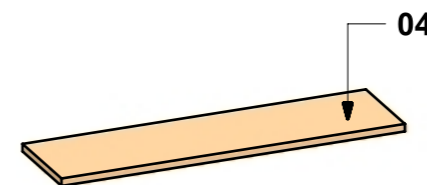
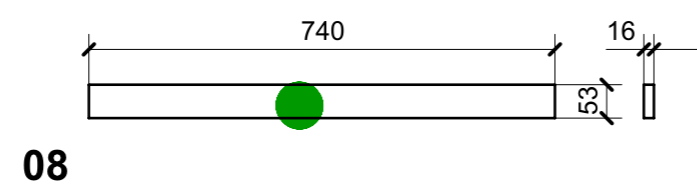
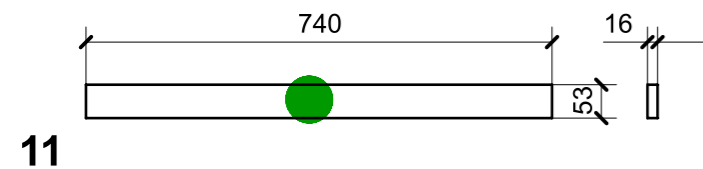
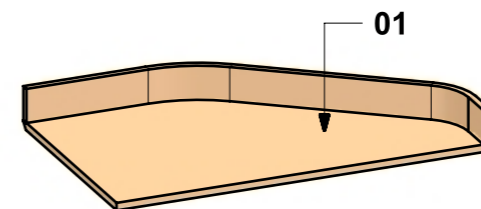
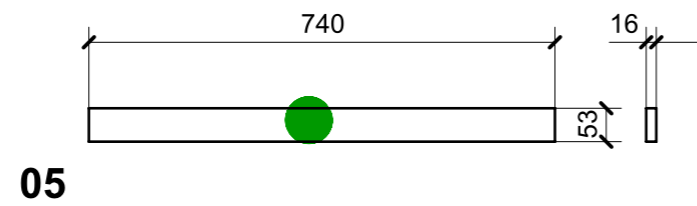
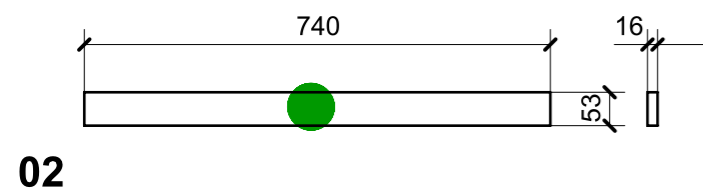
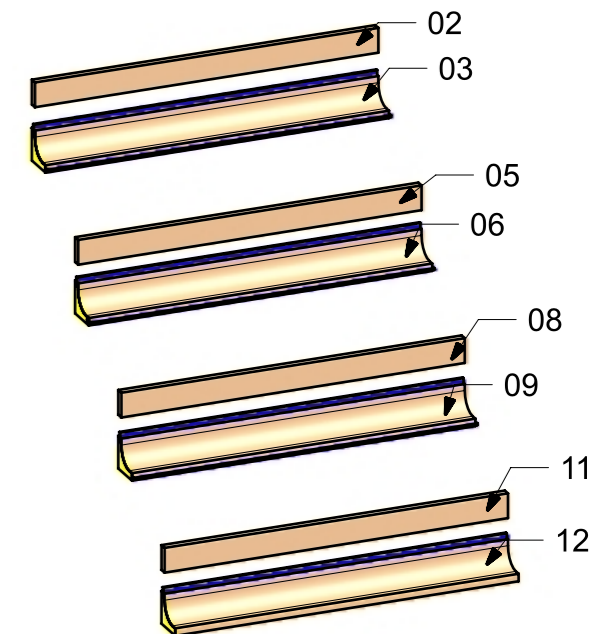
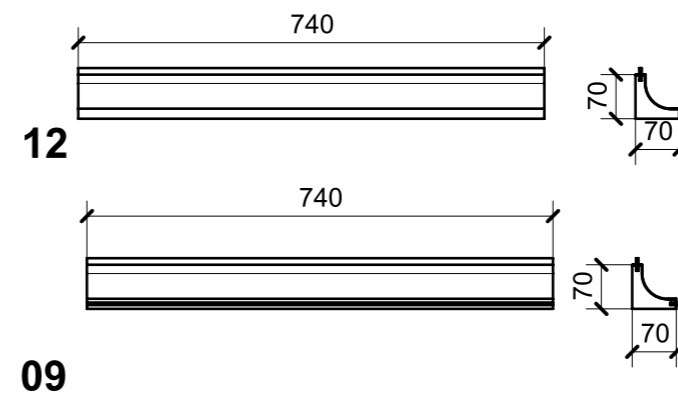
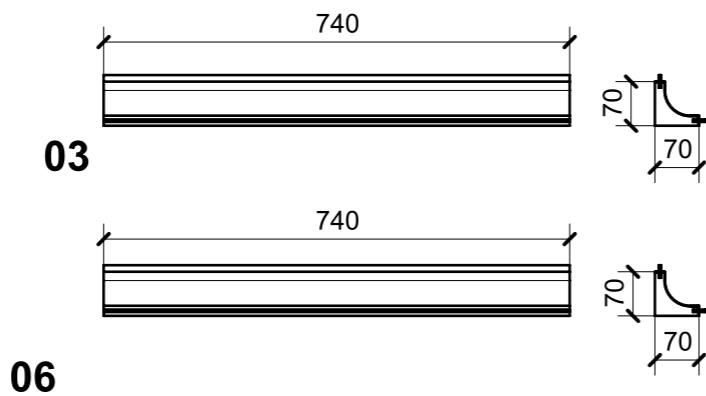
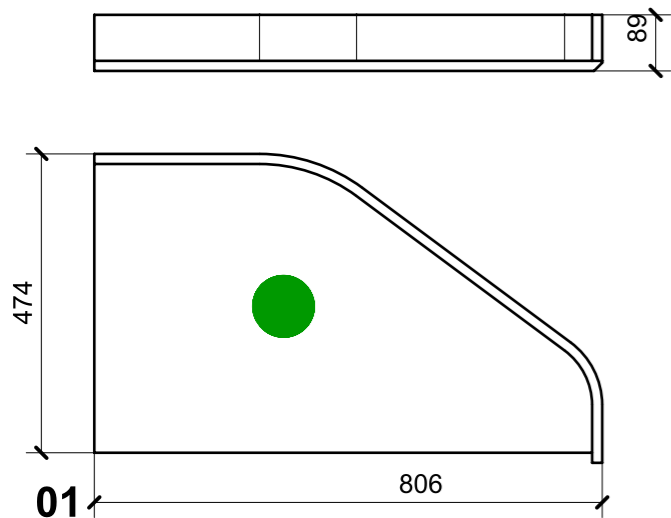

01

07

VERNICIATURA LASTRA/LACCATI:

● = VERNICIARE 1 LATO + FILI RASATI O BORDATI

NESSUN SIMBOLO = VERNICIARE 2 LATI + FILI RASATI O BORDATI

LOCALE	CODICE	DESCRIZIONE COMPONENTE	FINITURA	GR.
TIMONERIA	MD320_R02_TY01	RIV. GRADINI DISCESA ARMATORE	LASTRA CHIARA	2

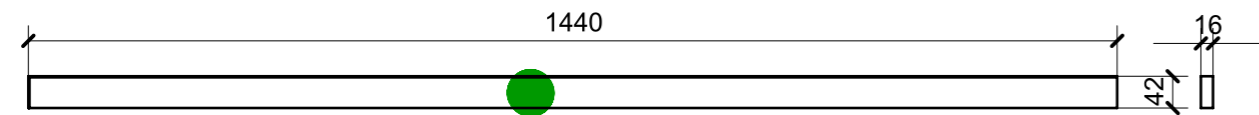

01

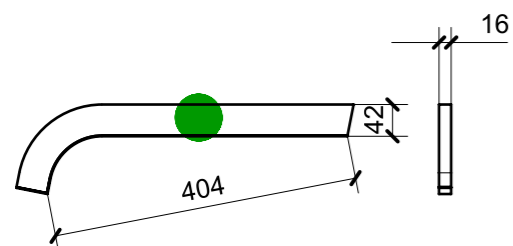

02

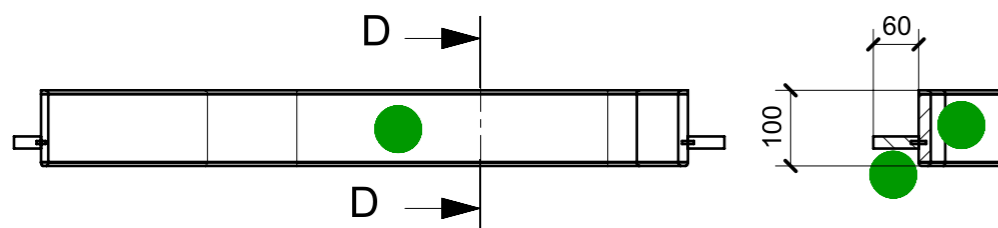

SECTION D-D

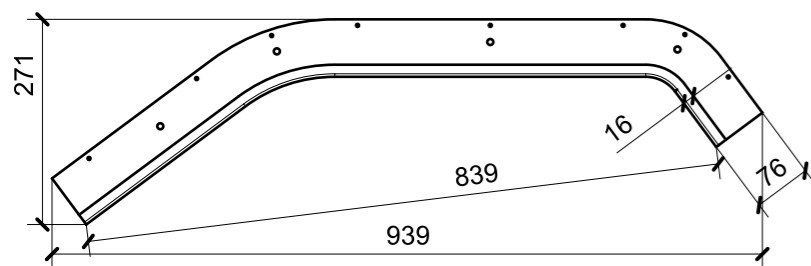

03

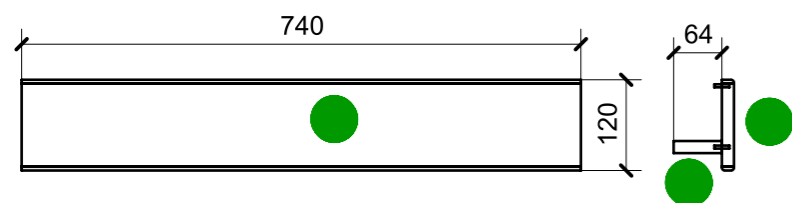

04

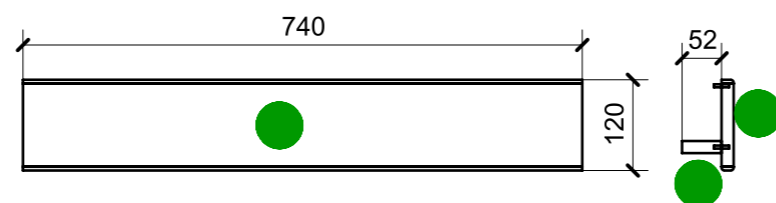

05

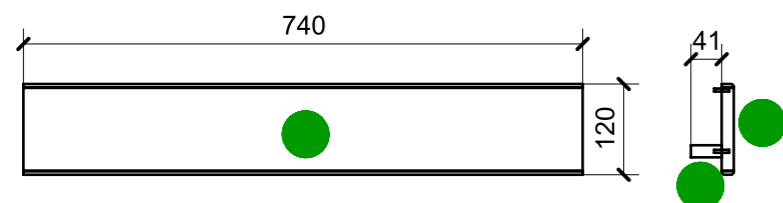

06

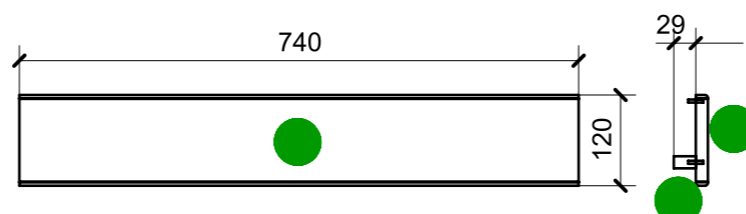

07

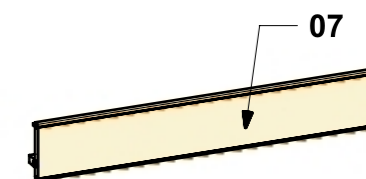
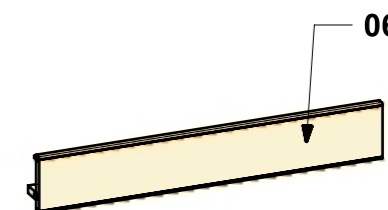
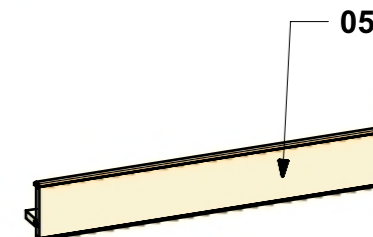
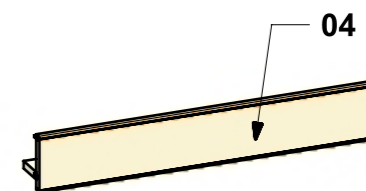
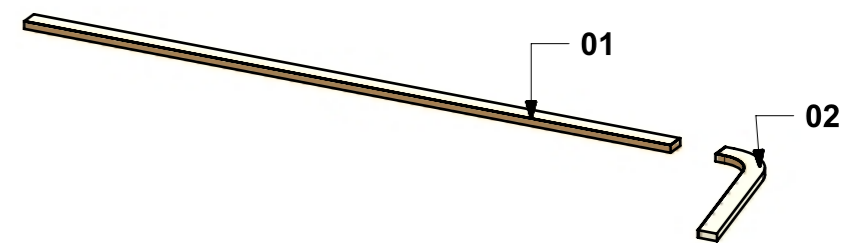

VERNICIATURA LASTRA/LACCATI:

● = VERNICIARE 1 LATO + FILI RASATI O BORDATI

NESSUN SIMBOLO = VERNICIARE 2 LATI + FILI RASATI O BORDATI