

LOCALE	CODICE	DESCRIZIONE COMPONENTE	FINITURA	Q.TA
CUCINA	MD298_R01_KA01	BASE CUCINA	LASTRA CHIARA	1

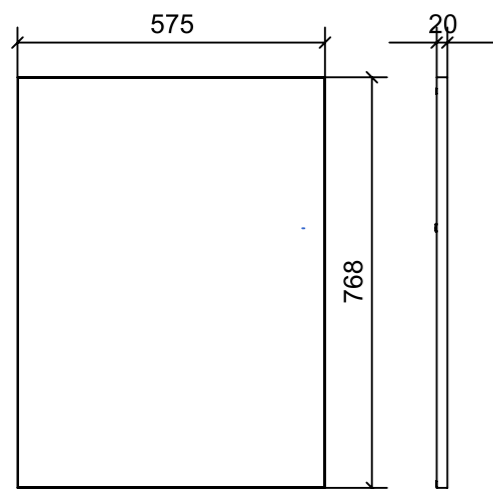

**01**

FERRAMENTA	QTY
PLACCHETTA COUNTER STEEL_TECHNOPARTNER_MC-JM49	1
GOMMINO PARACOLPO ANTA	2

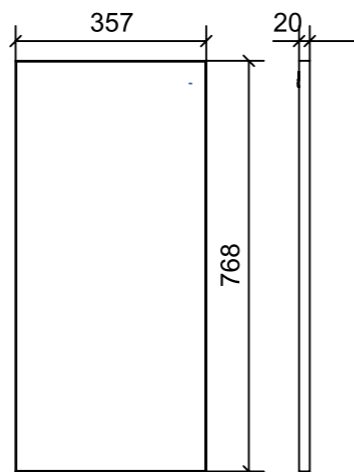

**02**

FERRAMENTA	QTY
PLACCHETTA COUNTER STEEL_TECHNOPARTNER_MC-JM49	1
GOMMINO PARACOLPO ANTA	1

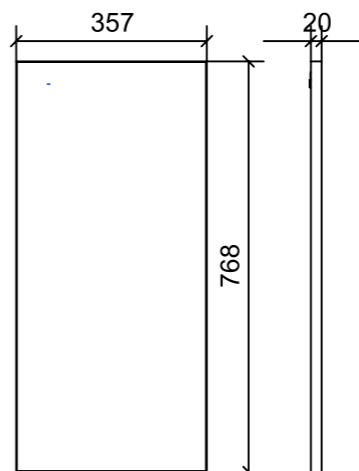

**03**

FERRAMENTA	QTY
PLACCHETTA COUNTER STEEL_TECHNOPARTNER_MC-JM49	1
GOMMINO PARACOLPO ANTA	1

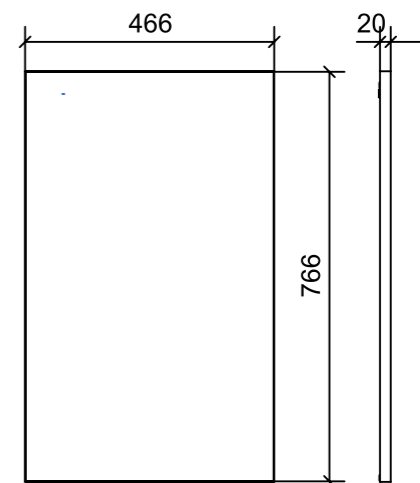

**04**

FERRAMENTA	QTY
PLACCHETTA COUNTER STEEL_TECHNOPARTNER_MC-JM49	1
GOMMINO PARACOLPO ANTA	2

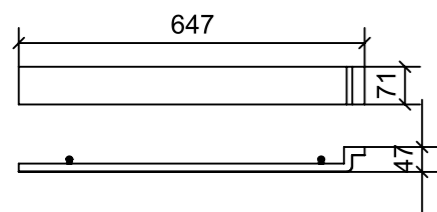

**09**

FERRAMENTA	QTY
MS INCASSO_ITALVIPLA_972_FMPC_M1B	2

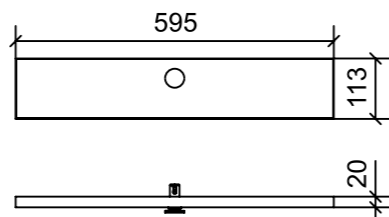

**07**

FERRAMENTA	QTY
BUSSOLA 5MA X 10 FORO DIAM.8	2
DADO CH.22 X FLUSH LOCK _RAZETO & CASARETO_800432	1
FLUSH LOCK CON SCONTRO _RAZETO & CASARETO_800402	1

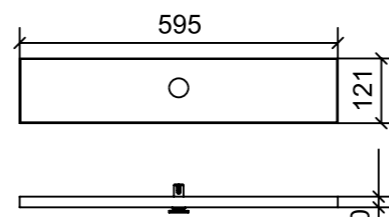

**08**

FERRAMENTA	QTY
BUSSOLA 5MA X 10 FORO DIAM.8	2
DADO CH.22 X FLUSH LOCK _RAZETO & CASARETO_800432	1
FLUSH LOCK CON SCONTRO _RAZETO & CASARETO_800402	1

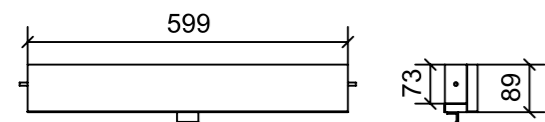

**06**

FERRAMENTA	QTY
RISCONTRO X FLUSH LOCK INCLUSO NEL KIT _RAZETO & CASARETO	1
VITE 6MA X 25 TESTA BOMBATA	2

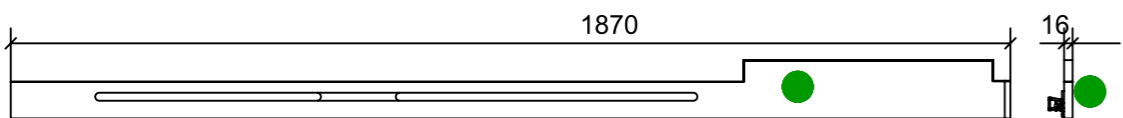

**10**

FERRAMENTA	QTY
MS INCASSO_ITALVIPLA_972_FMPC_M1B	6
KEKU ESTRAZIONE FRONTALE PARTE PANNELLO AS_HAFELE_262_50_359	1

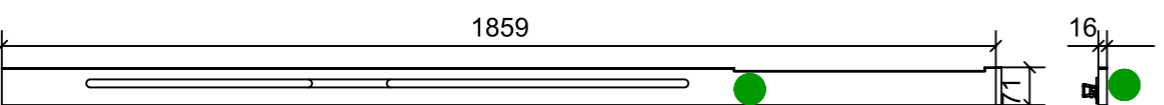

**11**

FERRAMENTA	QTY
KEKU ESTRAZIONE FRONTALE PARTE PANNELLO AS_HAFELE_262_50_359	1
MS INCASSO_ITALVIPLA_972_FMPC_M1B	6

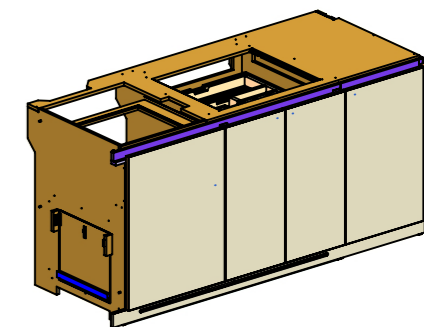
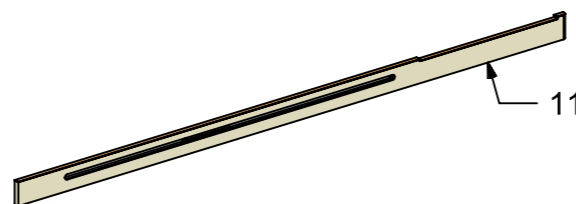

ELEMENTI DA MONTARE  
in MF\_KA01  
e spedire con unico imballo

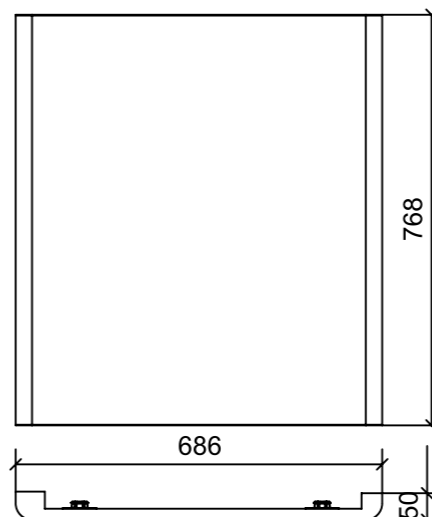
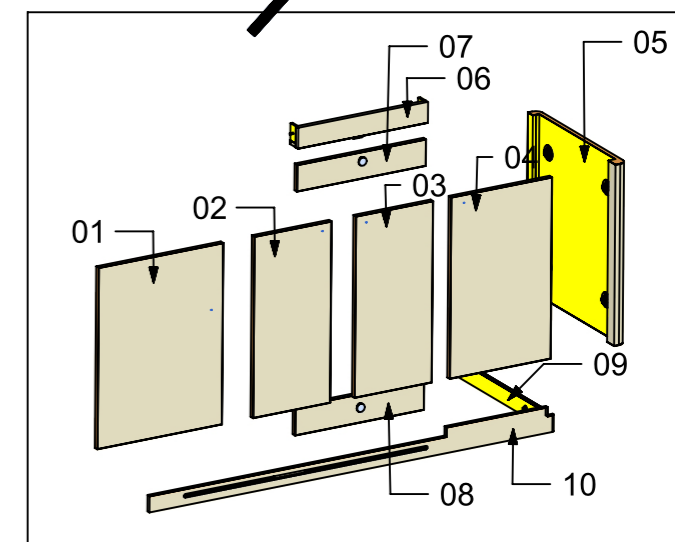

**05**

FERRAMENTA	QTY
FITLOCK M_MASCHERPA_3MM_6020202101	4

VERNICIATURA LASTRA/LACCATI:

● = VERNICIARE 1 LATO + FILI RASATI O BORDATI

NESSUN SIMBOLO = VERNICIARE 2 LATI + FILI RASATI O BORDATI

LOCALE	CODICE	DESCRIZIONE COMPONENTE	FINITURA	GR.
CUCINA	MD298_R01_KB01	MOBILE STORAGE AD ANGOLO	LASTRA CHIARA	8

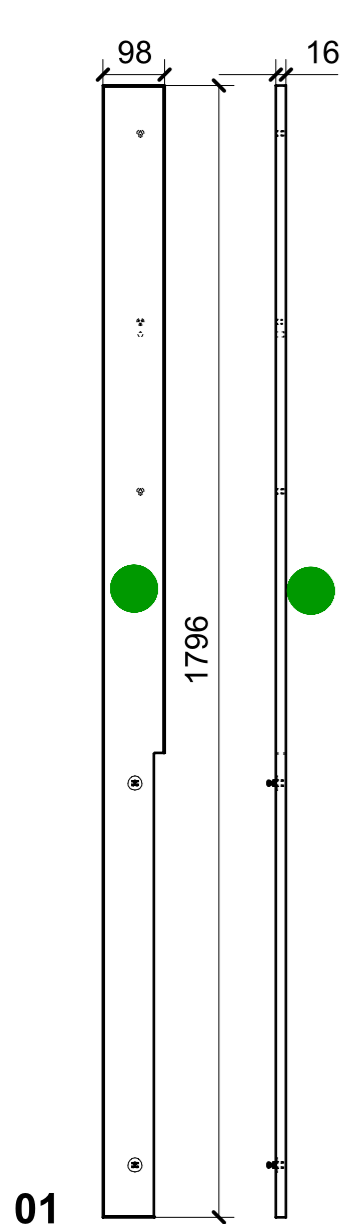

FERRAMENTA	QTY
BUSSOLA 5MA X 10 FORO DIAM.8	3
MS INCASSO_ITALVIPLA_972_FMPC_M1B	2

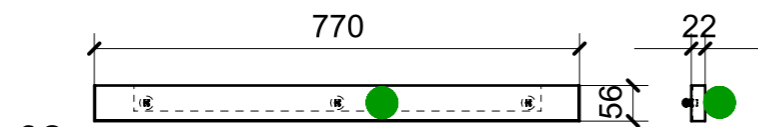

FERRAMENTA	QTY
MD298_GR8_KB01_06	1
MS INCASSO_ITALVIPLA_972_FMPC_M1B	3

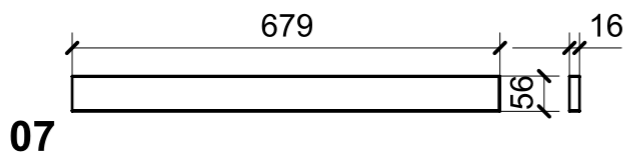
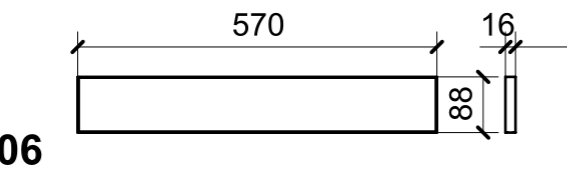
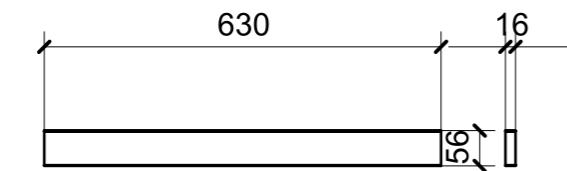

01

07

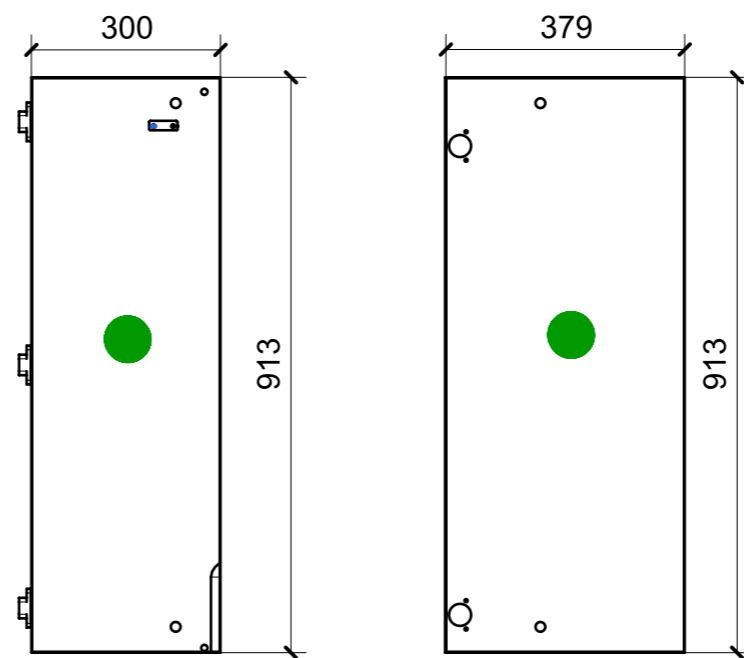

FERRAMENTA	QTY
MD298_GR8_KB01_06	1
PLACCHETTA COUNTER STEEL_TECHNOPARTNER_MC-JM49	1
CERNIERA INVISIBILE SOSS 204_FBC BORGHI_00373883	3
GOMMINO PARACOLPO ANTA	2

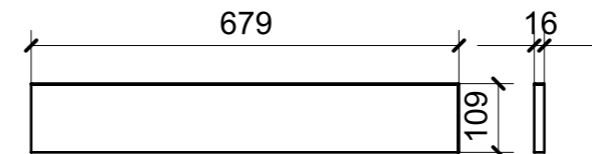
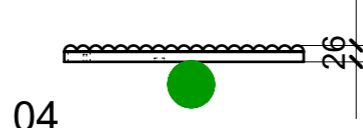
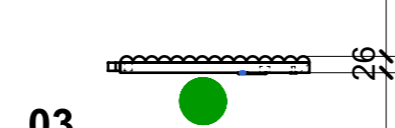

08

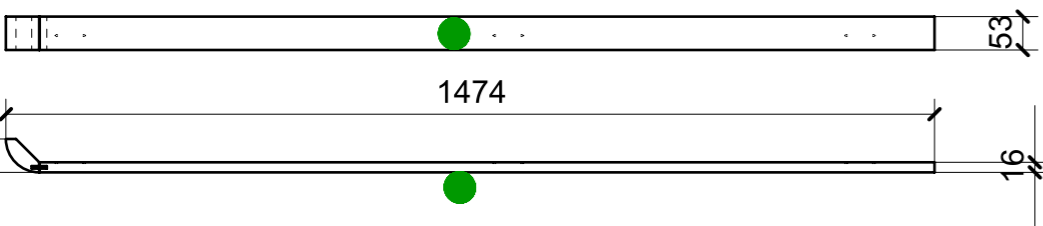

09

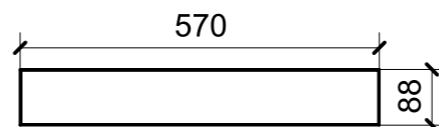

10

ELEMENTI DA MONTARE  
con KB01\_01-->05 in MF\_KB01  
e spedire con unico imballo

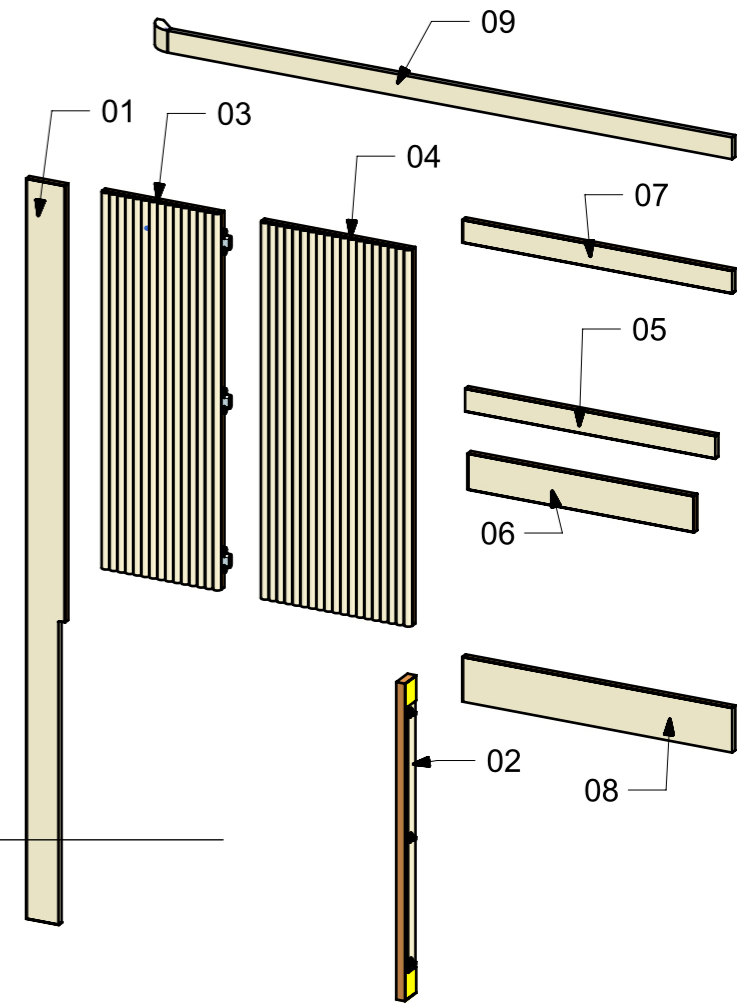

**VERNICIATURA LASTRA/LACCATI:**  
● = VERNICIARE 1 LATO + FILI RASATI O BORDATI  
NESSUN SIMBOLO = VERNICIARE 2 LATI + FILI RASATI O BORDATI

LOCALE	CODICE	DESCRIZIONE COMPONENTE	FINITURA	GR
CUCINA	MD298_R01_KD01	STRUTTURA FRIGO	LASTRA CHIARA/MDF	5

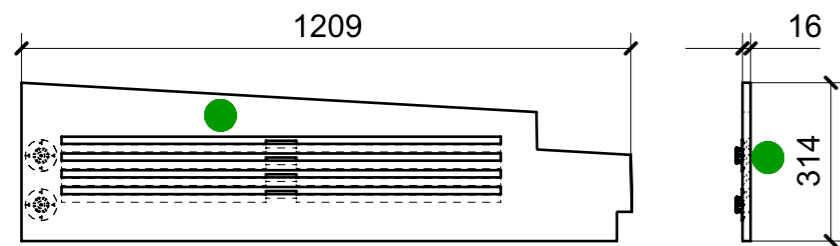

01

FERRAMENTA	QTY
FITLOCK M_MASCHERPA_3MM_6020202101	2

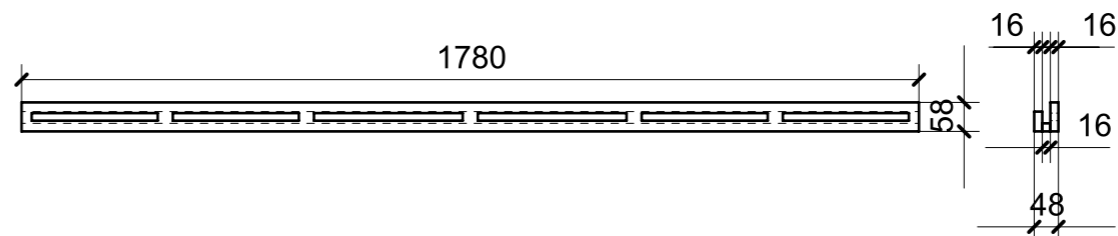

06

FERRAMENTA	QTY
MS INCASSO_ITALVIPLA_972_FMPC_M1B	3

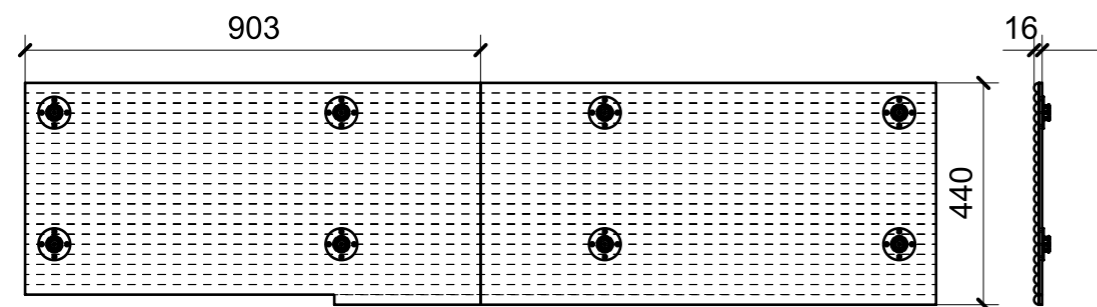

02

FERRAMENTA	QTY
FITLOCK M_MASCHERPA_3MM_6020202101	8

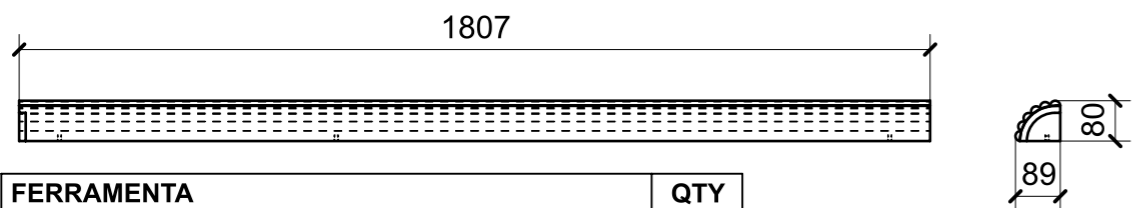

03

FERRAMENTA	QTY
BUSSOLA 6MA X 10 FORO DIAM.8	3

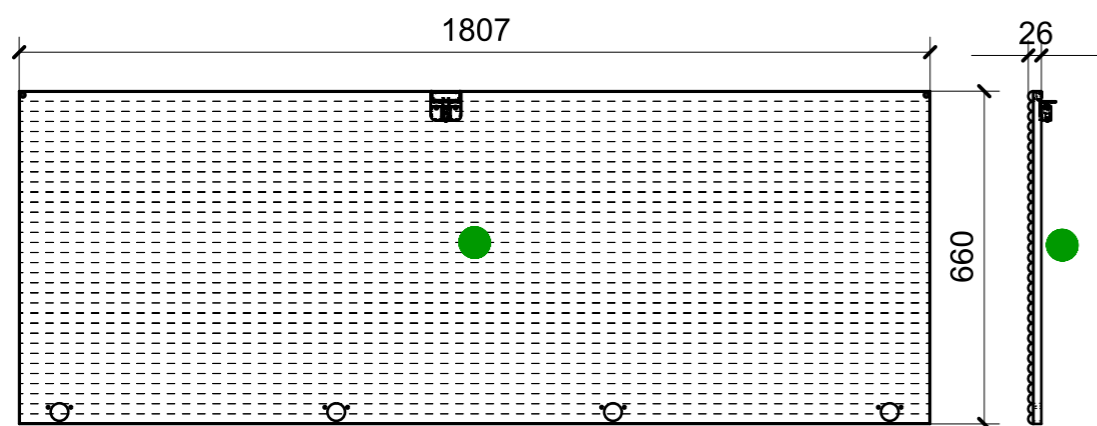

04

FERRAMENTA	QTY
GOMMINO PARACOLPO ANTA	2
MANIGLIA AD INCASSO_FORESTI_ART 238 C	1

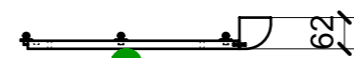
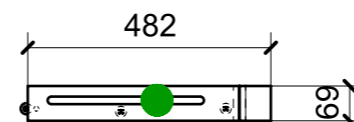

07

FERRAMENTA	QTY
MS INCASSO_ITALVIPLA_972_FMPC_M1B	3

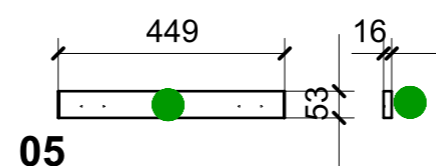
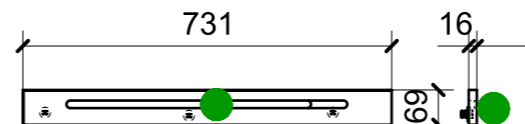

05

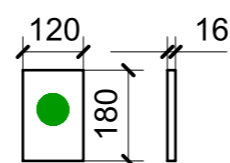

09

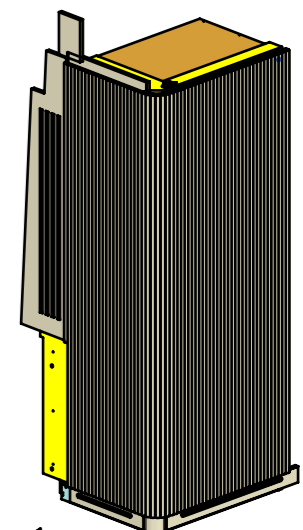

ELEMENTI DA MONTARE  
con KD01\_01-->05 in MF\_KD01  
e spedire con unico imballo

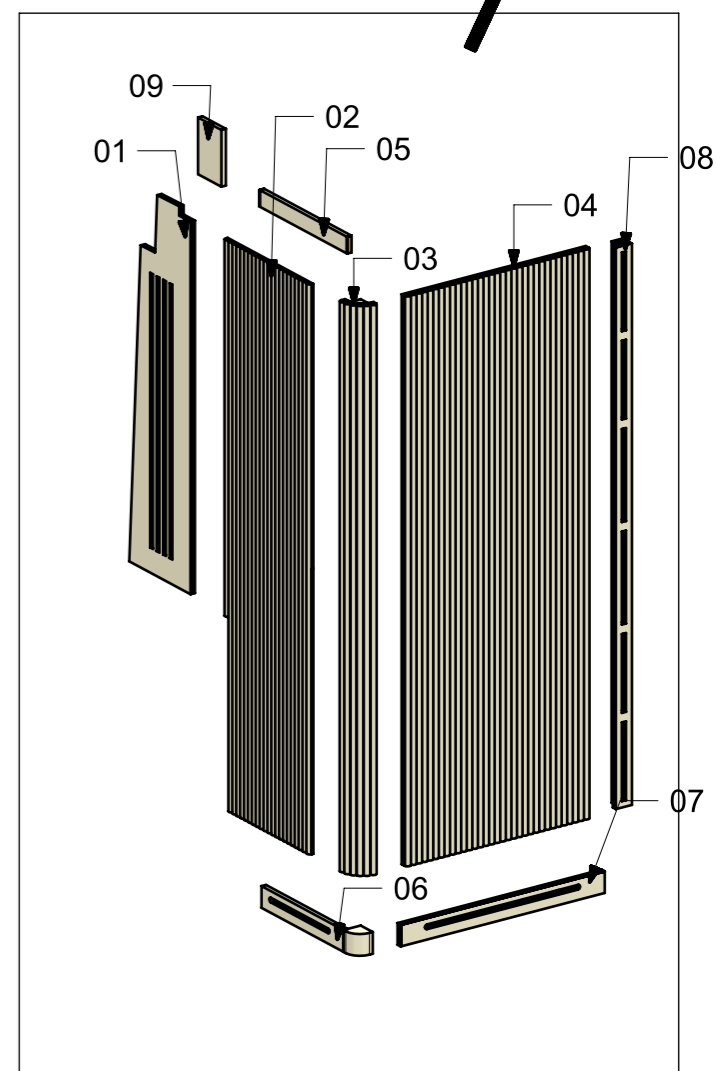

VERNICIATURA LASTRA/LACCATI:

● = VERNICIARE 1 LATO + FILI RASATI O BORDATI

NESSUN SIMBOLO = VERNICIARE 2 LATI + FILI RASATI O BORDATI