

AZ53F

DA MAT. 221 REV. 26-06-2024

LOCALE	CODICE	DESCRIZIONE COMPONENTE	FINITURA	Q.TA	OPERATORE
CUCINA	AZ53F-MF_KC01	COLONNA INGRESSO DX			Damiano

118-164
SCHIENALE
ASPORTABILE E
MODIFICATO
STRUTTURA INTERNA

FERRAMENTA:

- N° 2- CERNIERA CON COLLO PIENO SENZA MOLLA
- N° 2 - Basetta H0
- N° 8 - ANKOR BORGHI
- N° 2- CERNIERA INVISIBILE
- N° 1 - KIT ANTA A RIBALTA (=AZ60 mobile lavatrice)
- N° 2 - CERNIERE COME AZ60 mobile lavatrice
- N° 6 - GOMMINO PARACOLPO
- N° 2 - GUIDA DA 550
- N° 2 - GANCIO FERMA CASSETTO LAMP SUS304PAT
- N° 3 - PREMI E APRI speciale
- N° 10 - SOUTHCO

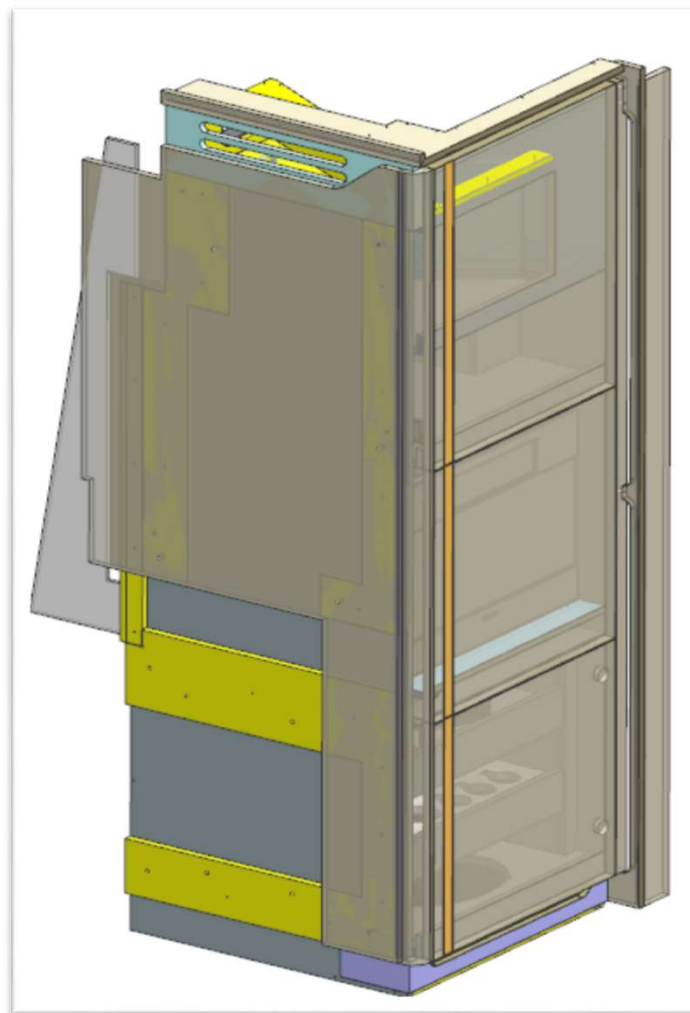

AZ53F

DA MAT. 221 REV. 26-06-2024

LOCALE	CODICE	DESCRIZIONE COMPONENTE	FINITURA	Q.TA	OPERATORE
CUCINA	AZ53F-KC01	COLONNA INGRESSO DX	LAMINATO NADIR	3	Damiano

**164 - SCHIENALE
ASPORTABILE**

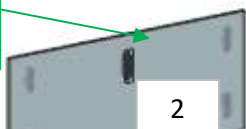

**118 - ELIMINATO
DOPPIO RIPIANO**

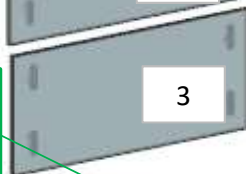

FERRAMENTA:

- N° 2 - CERNIERA CON COLLO PIENO SENZA MOLLA
- N° 2 - Basetta H6
- N° 8 - ANKOR BORGHI
- N° 2 - CERNIERA INVISIBILE
- N° 1 - KIT ANTA A RIBALTA DA 60cm
- N° 2 - CERNIERE PIANE 94° SENZA MOLLA
- N° 6 - GOMMINO PARACOLPO
- N° 2 - GUIDA DA 550
- N° 2 - GANCIO FERMA CASSETTO LAMP SUS304PAT
- N° 3 - PREMI E APRI speciale
- N° 7 - SOUTHCO
- GANCI CASSETTI

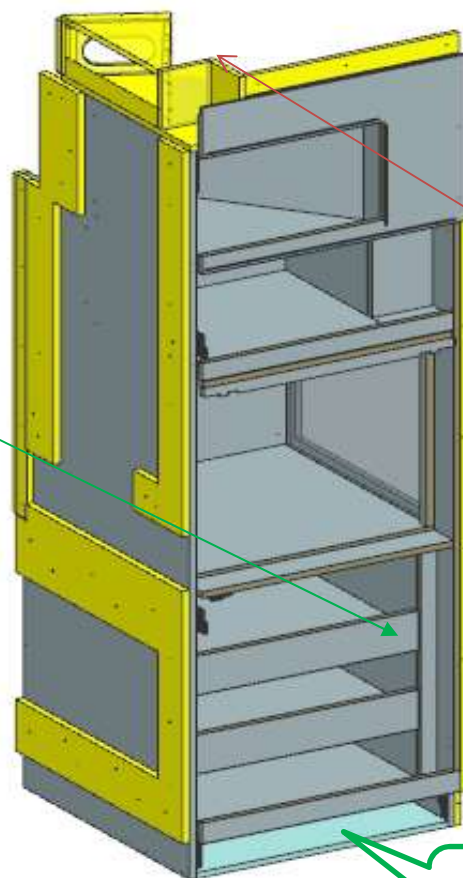

**SPRUZZARE DI
NERO I
PLENUM**

**ELEMENTO DA
MONTARE con:
R01_KA01
L01_KA01
X01_KA01
e spedire con un unico
imballo**

L01_KC01

R01_KC01

L02_KC01

P01_KC01

X01_KC01

**VERNICIARE
ANTIMUFFA**

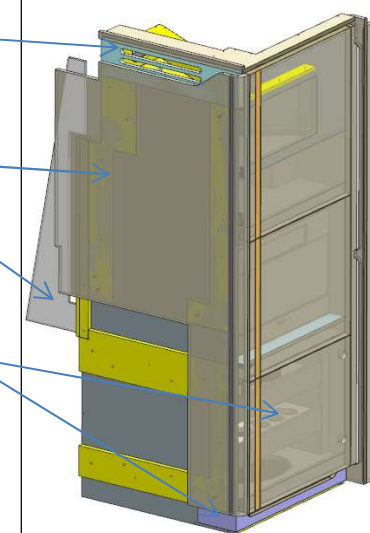

AZ53F

DA MAT. 221 REV. 26-06-2024

LOCALE	CODICE	DESCRIZIONE COMPONENTE	FINITURA	Q.TA	OPERATORE
CUCINA	AZ53F-R01_KC01	COLONNA INGRESSO DX	LASTRA CHIARA	6	Damiano

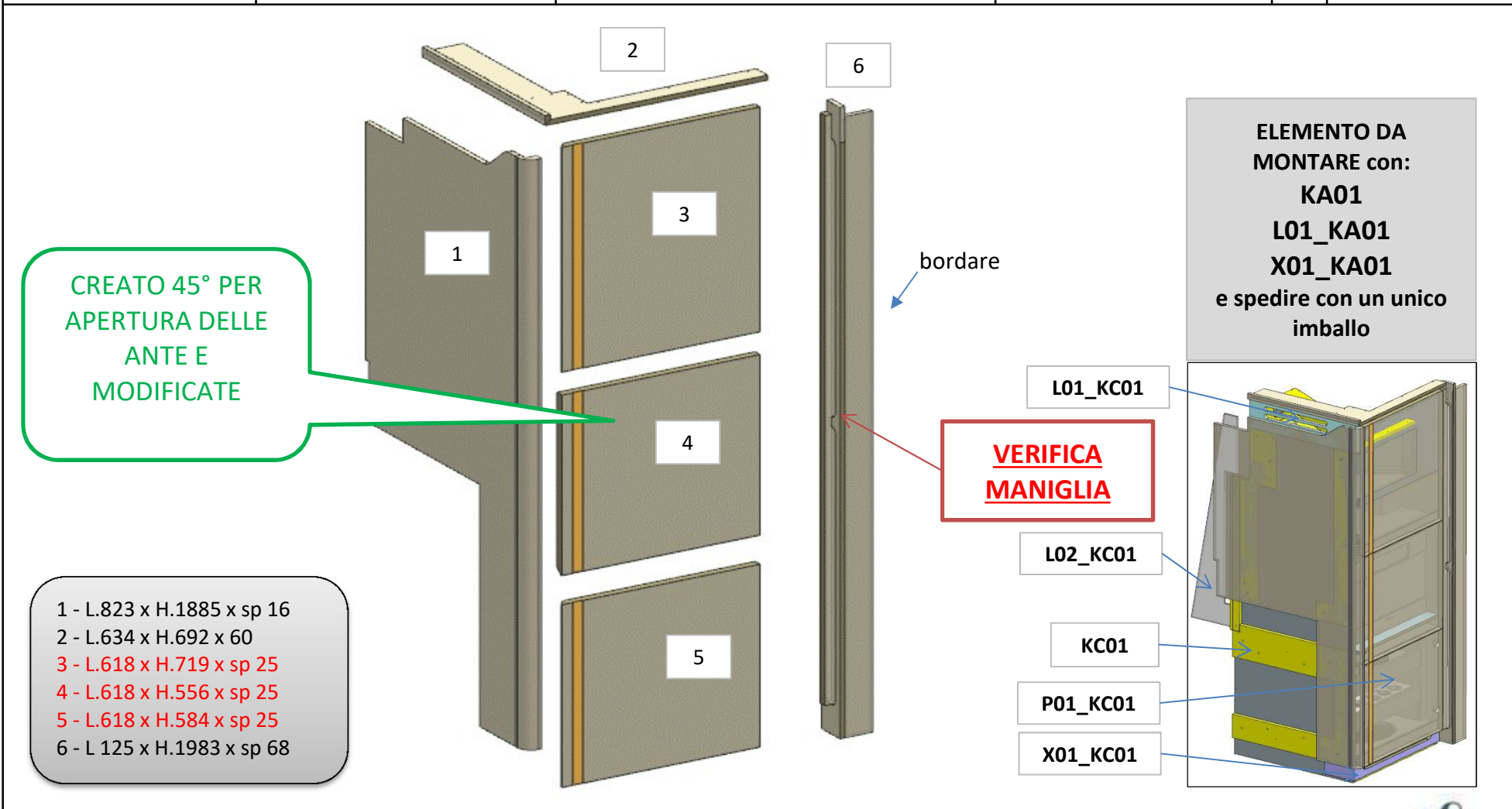

AZ53F

DA MAT. 221 REV. 26-06-2024

LOCALE	CODICE	DESCRIZIONE COMPONENTE	FINITURA	Q.TA	OPERATORE
CUCINA	AZ53F-L01_KC01	COLONNA INGRESSO DX	LACCATO NERO GOFFRATO	2	Damiano

1 - L.605 x H.162 x sp 34
2 - L.651 x H.71 x sp 16

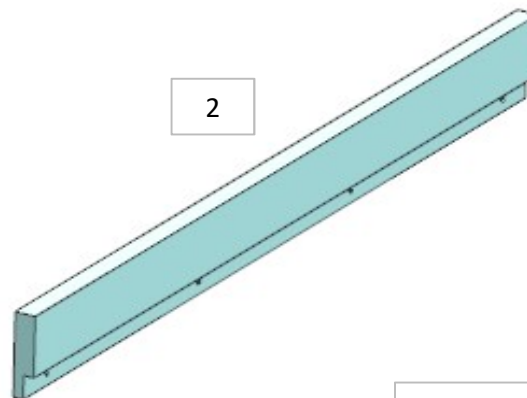
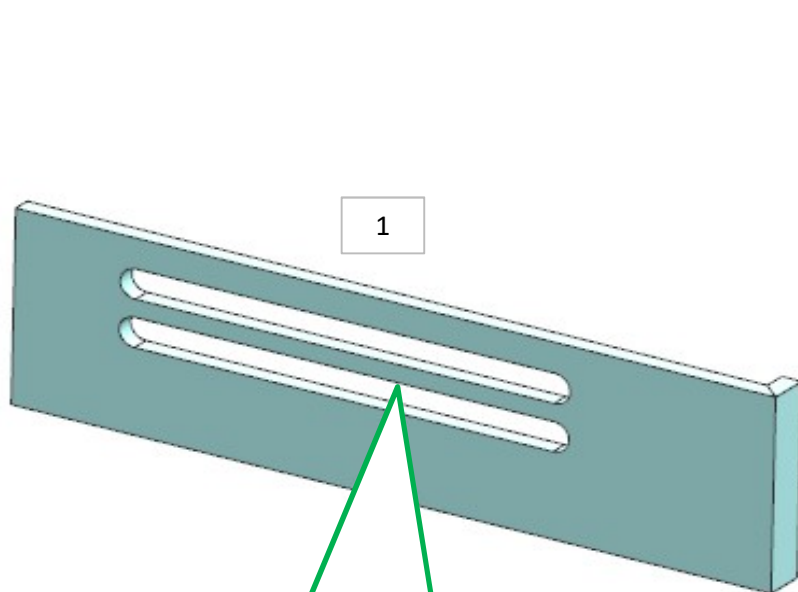

ELEMENTO DA
MONTARE con:
R01_KA01
KA01
X01_KA01
e spedire con un unico
imballo

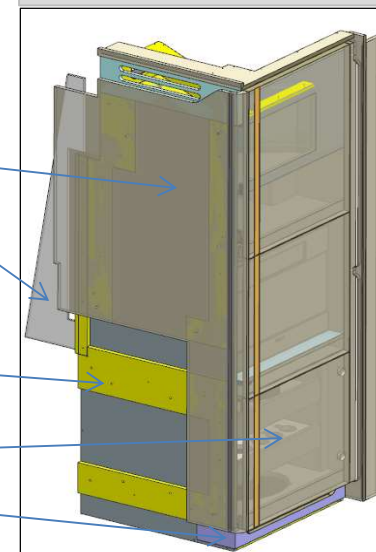

R01_KC01

L02_KC01

KC01

P01_KC01

X01_KC01

88

DUE ASOLE INVECE CHE UNA

AZ53F

REV. 26-06-2024

LOCALE	CODICE	DESCRIZIONE COMPONENTE	FINITURA	Q.TA	OPERATORE
CUCINA	AZ53F-L02_KC01	COLONNA INGRESSO DX	LACCATO BIANCO GOFFRATO	1	Damiano

1 - L.258 x H.1171 x sp 10

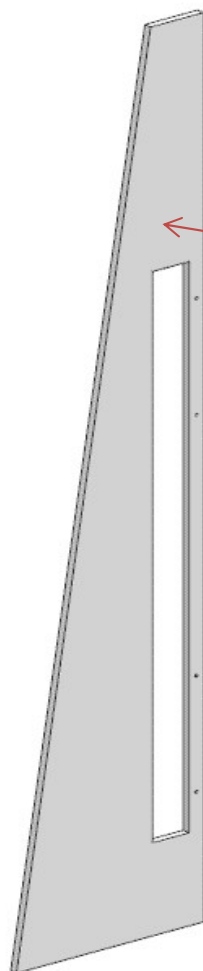

LATO BELLO

ELEMENTO DA
MONTARE con:
R01_KA01
L01_KA01
X01_KA01
e spedire con un unico
imballo

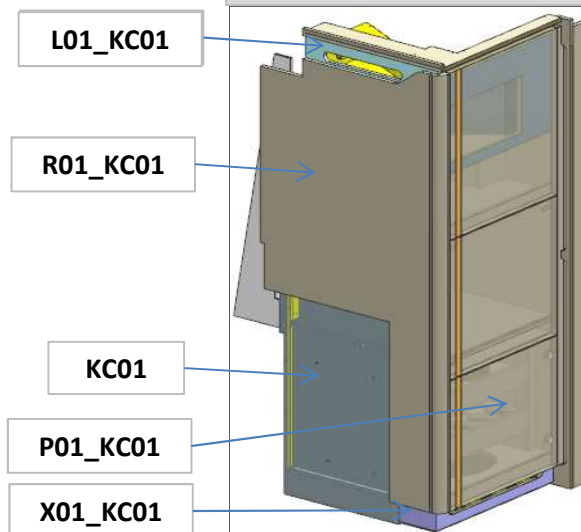

consonni&c

AZ53F

REV. 2025

LOCALE	CODICE	DESCRIZIONE COMPONENTE	FINITURA	Q.TA	OPERATORE
CUCINA	AZ53F-P01_KC01	COLONNA INGRESSO DX-portavasellame	FAGGIO\ GOMMA	8	Damiano

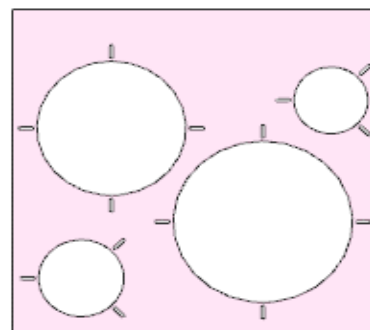
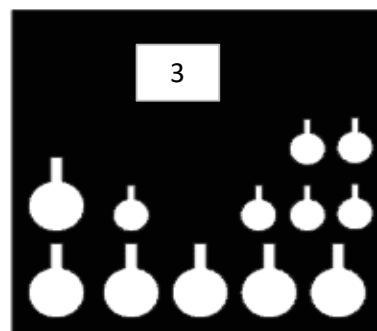
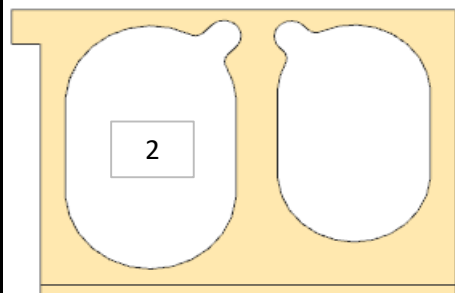

5

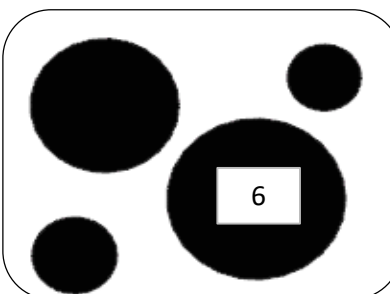
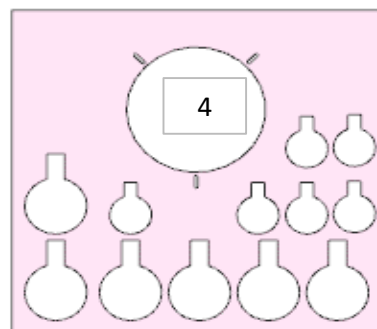
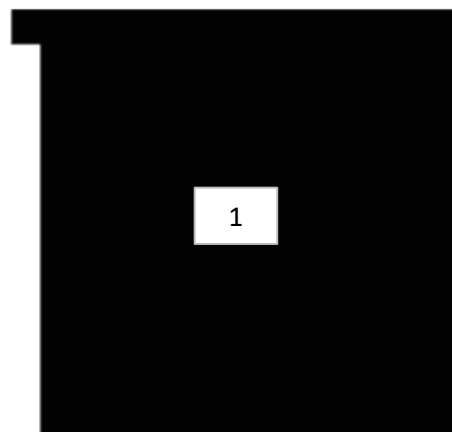

L01_KC01

R01_KC01

ELEMENTO DA MONTARE con:
R01_KA01
L01_KA01
X01_KA01
 e spedire con un unico imballo

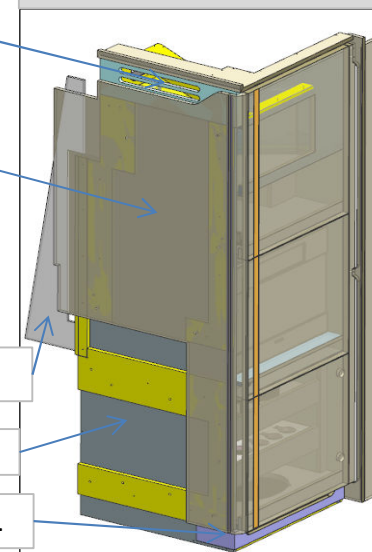

L02_KC01

KC01

X01_KC01

- 1 - L 618 x H 659 x sp 19
- 2 - L 618 x H 442 x sp 60
- 3 - 4 - L 554 x H 539 x sp 19
- 5 - L 552 x H 539 x sp 19

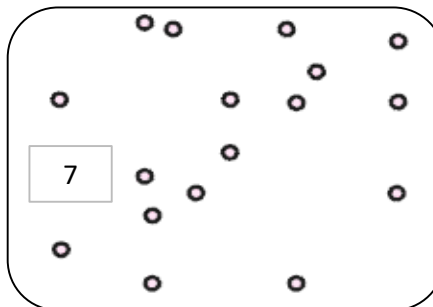
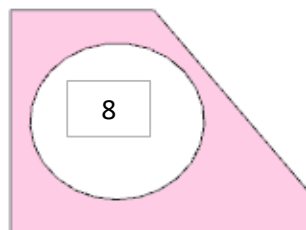

7

AZ53F

DA MAT. 201 REV. 26-06-2024

LOCALE	CODICE	DESCRIZIONE COMPONENTE	FINITURA	Q.TA	OPERATORE
CUCINA	AZ53F-X01_KC01	COLONNA INGRESSO DX	LAMINATO ACCIAIO	1	Damiano

1 - L.676 x H.75 x 169

MODIFICATA ALTEZZA
ZOCCOLO = h. 75

NON
BORDARE

ELEMENTO DA
MONTARE con:
R01_KA01
L01_KA01
X01_KA01
e spedire con un unico
imballo

L01_KC01

R01_KC01

L02_KC01

KC01

P01_KC01

consonni&c

AZ53F

REV. 26-06-2024

LOCALE	CODICE	DESCRIZIONE COMPONENTE	FINITURA	Q.TA	OPERATORE
CUCINA	AZ53F-KD01	CIELINO INGRESSO	OKOUME' GREZZO	1	Dante

1 - L.1797 x H.676 x sp 15

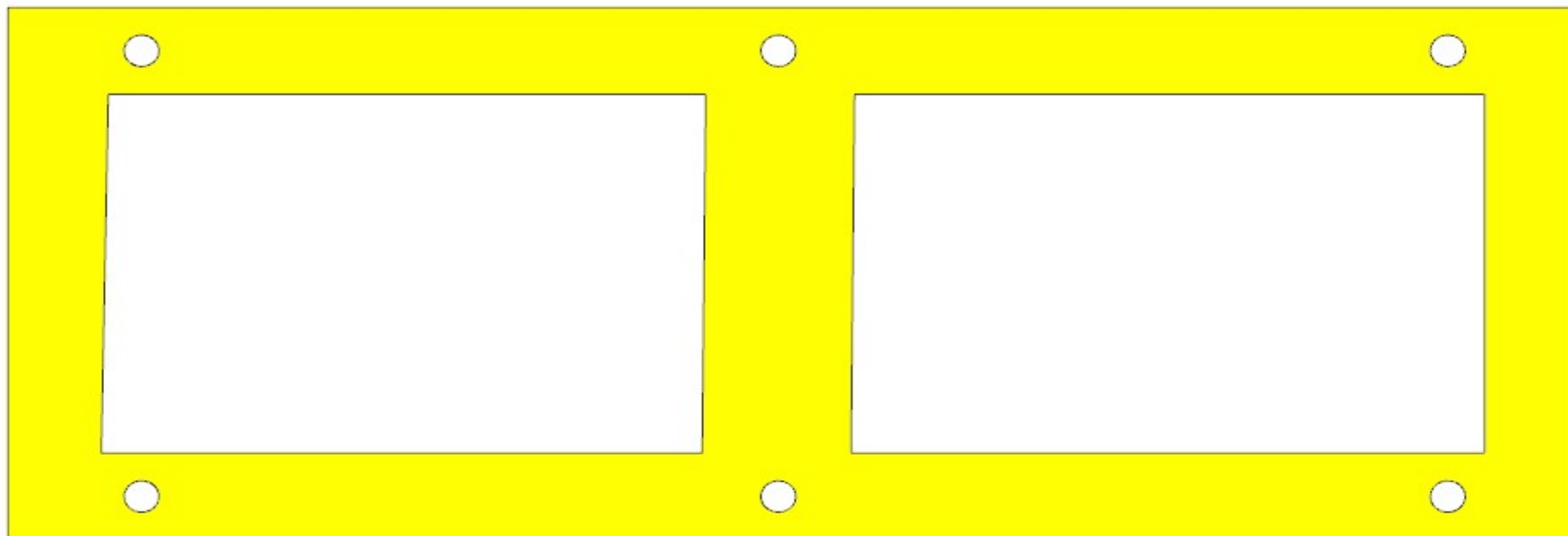

FERRAMENTA:

N° 6 - FITLOCK

AZ53F

DA MAT. 239 REV. 26-06-2024

LOCALE	CODICE	DESCRIZIONE COMPONENTE	FINITURA	Q.TA	OPERATORE
CUCINA	AZ53F-R01_KD01	CIELINO INGRESSO	LASTRA CHIARA	1	Damiano

1 - L.1797 x H 692 x sp 31

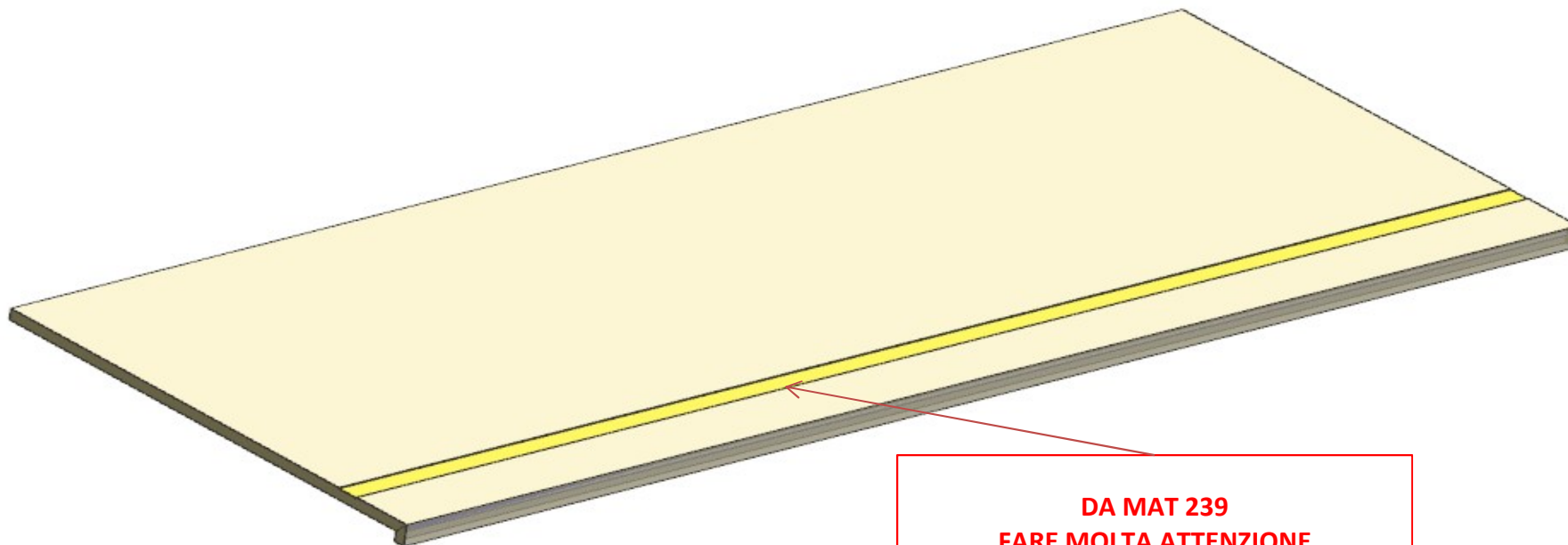

**DA MAT 239
FARE MOLTA ATTENZIONE
CONTROLLARE E PROTEGGERE BENE IL
LAMINATO BRONZO**

vedi misura fitlock interno

AZ53F

DA MAT. 201 REV. 26-06-2024

LOCALE	CODICE	DESCRIZIONE COMPONENTE	FINITURA	Q.TA	OPERATORE
CUCINA	AZ53F-R01_KE01	VANO TENDA	LASTRA CHIARA	1	Damiano

1 - L 2347 x H 65 x 102

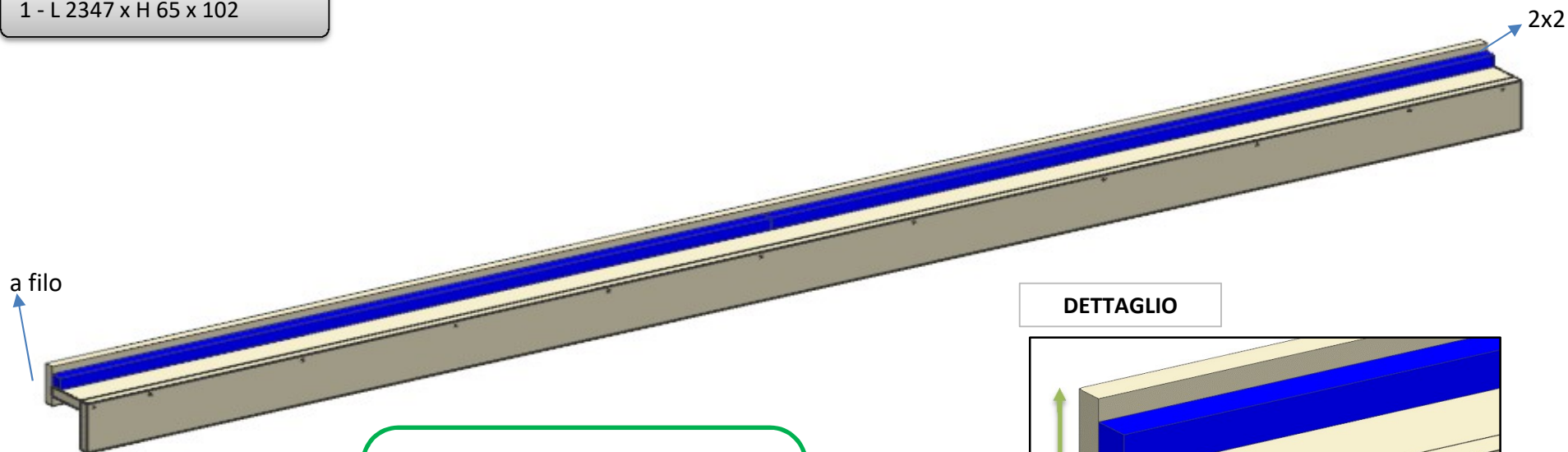

88
MODIFICATA MISURA FASCIA
DAVANTI - VERIFICARE
MISURA = h.65

DETTAGLIO

