

LOCALE	CODICE	DESCRIZIONE COMPONENTE	FINITURA	Q.TA
SALONE	MD299_L01_SSP01	FRONTALI CIELINO PLENUM SX CENTRO MURATA_STD_VAR 1	LACCATO BIANCO 9010	1

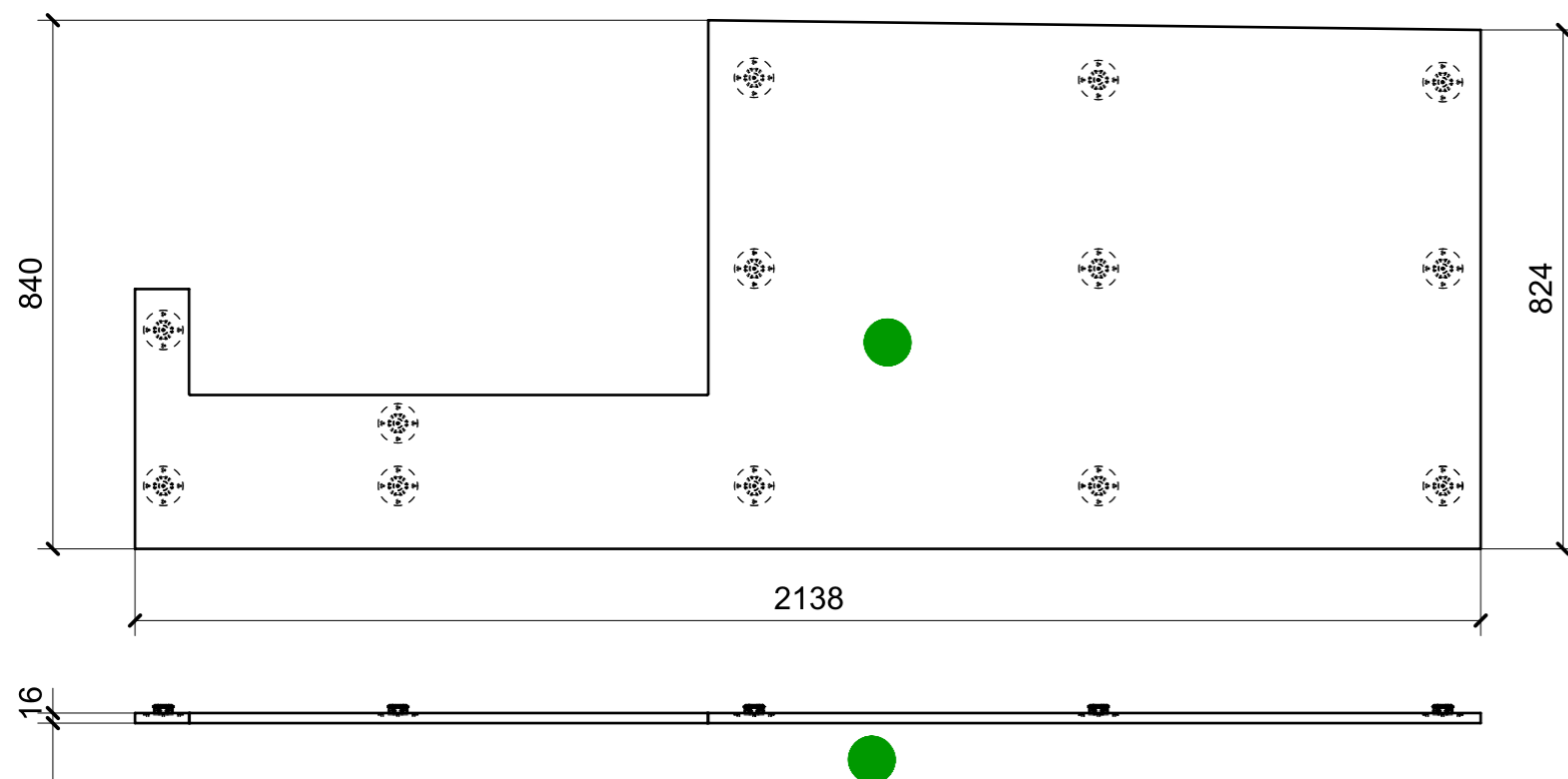

ELEMENTO DA MONTARE con R01\_02  
in MF\_SSP01  
e spedire con unico imballo

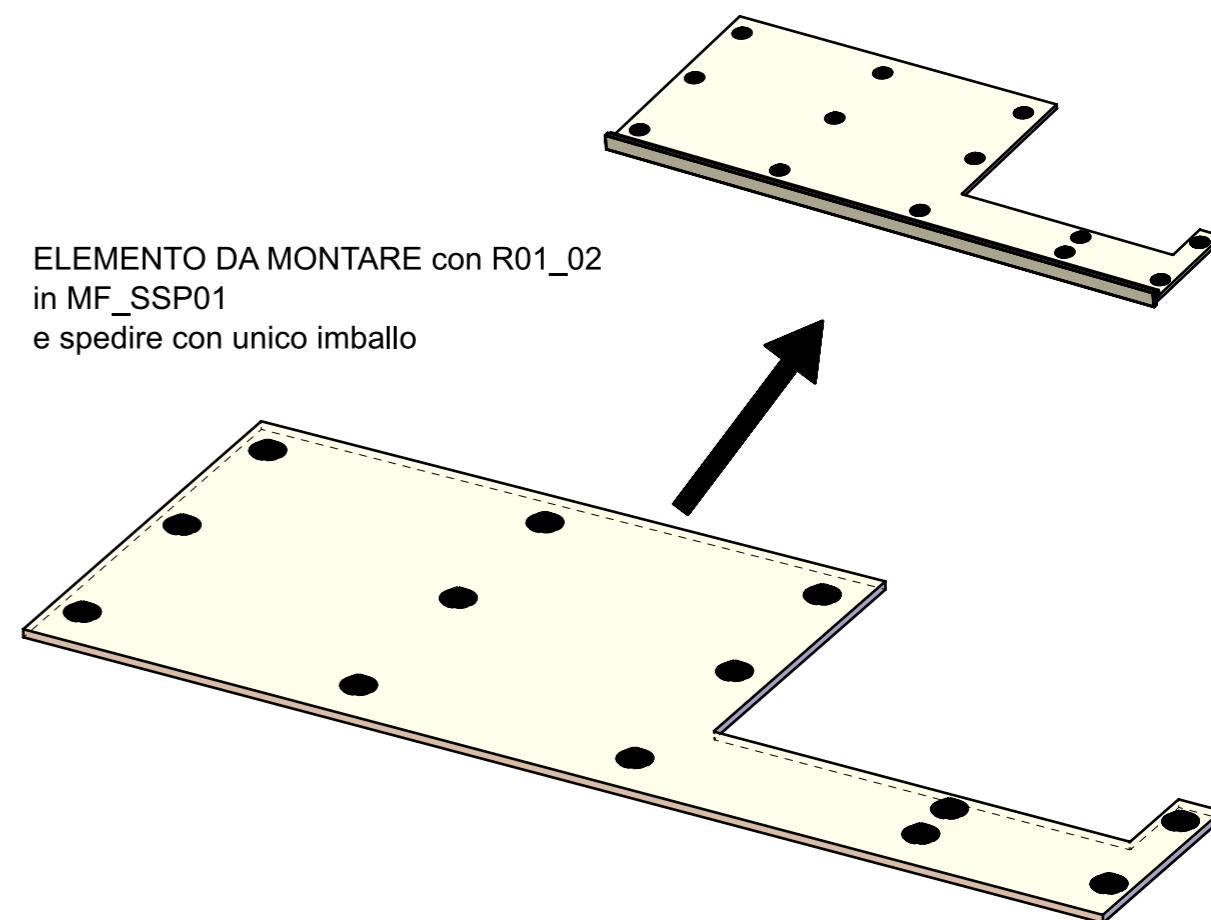

VERNICIATURA LASTRA/LACCATI:

● = VERNICIARE 1 LATO + FILI RASATI O BORDATI

NESSUN SIMBOLO = VERNICIARE 2 LATI + FILI RASATI O BORDATI

LOCALE	CODICE	DESCRIZIONE COMPONENTE	FINITURA	Q.TA
SALONE	MD299_L01_SPP01	FRONTALI CIELINO PLENUM SX CENTRO MURATA_STD_VAR 2	LACCATO BIANCO 9010	1

01

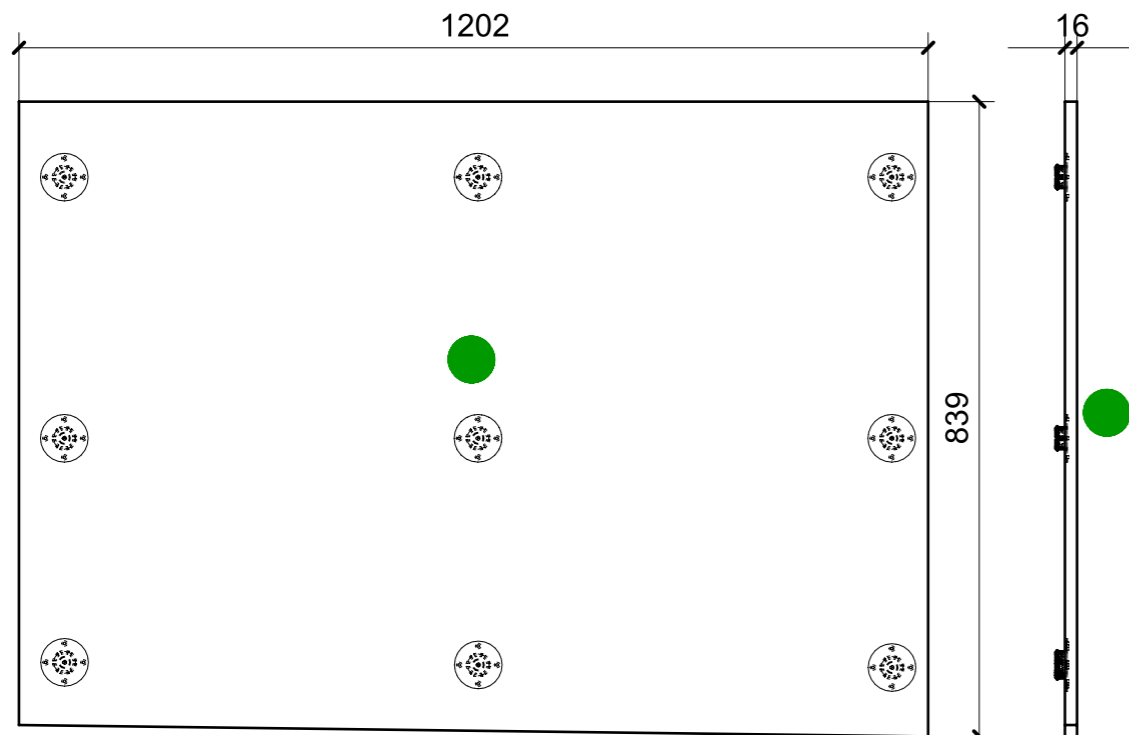

ELEMENTO DA MONTARE con R01\_SPP01\_02  
in MF\_SPP01  
e spedire con unico imballo

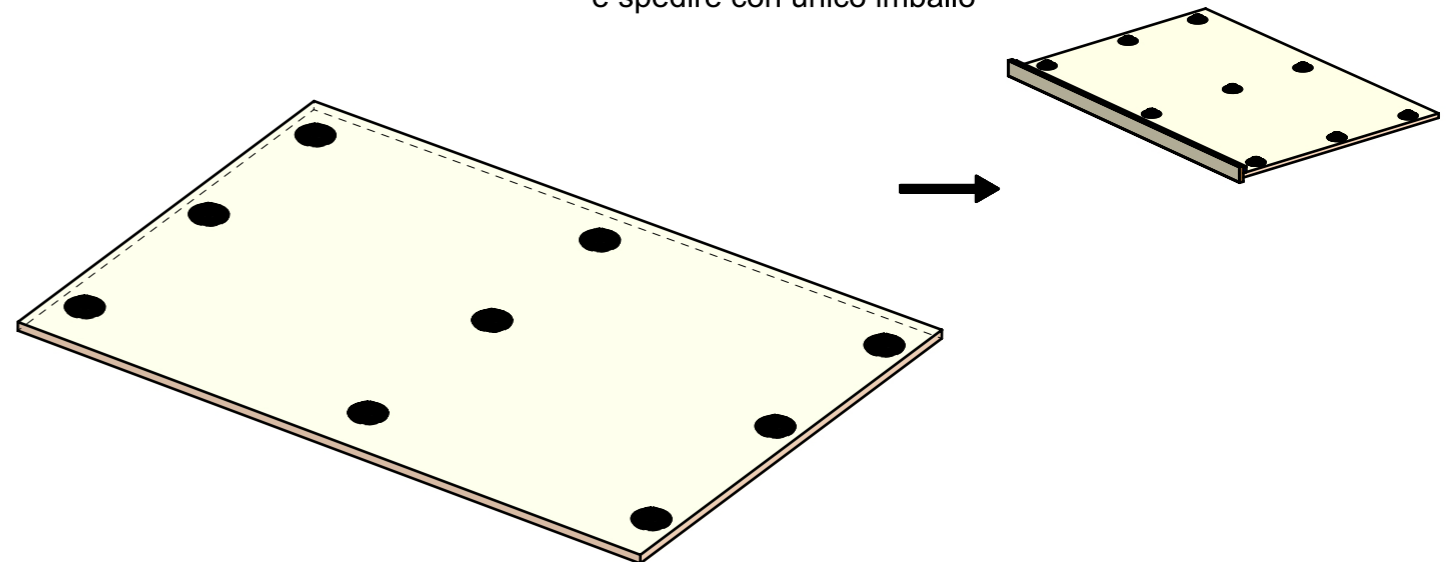

02

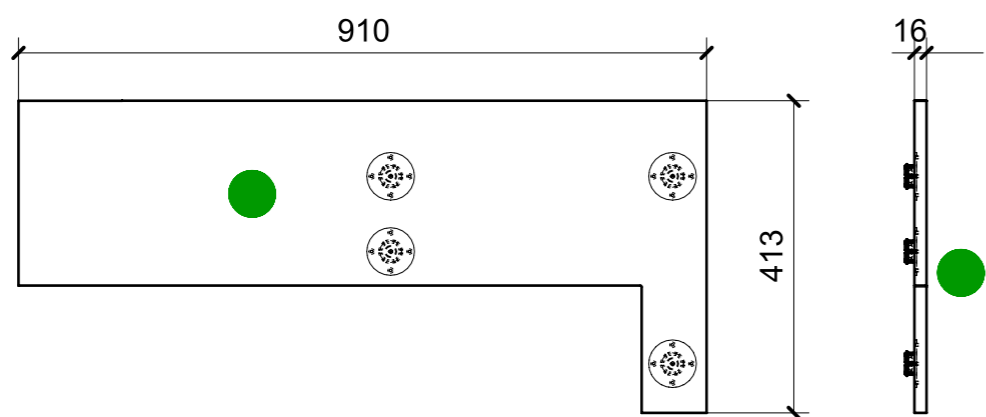

ELEMENTO DA MONTARE con R01\_SPP01\_04  
in MF\_SPP02  
e spedire con unico imballo

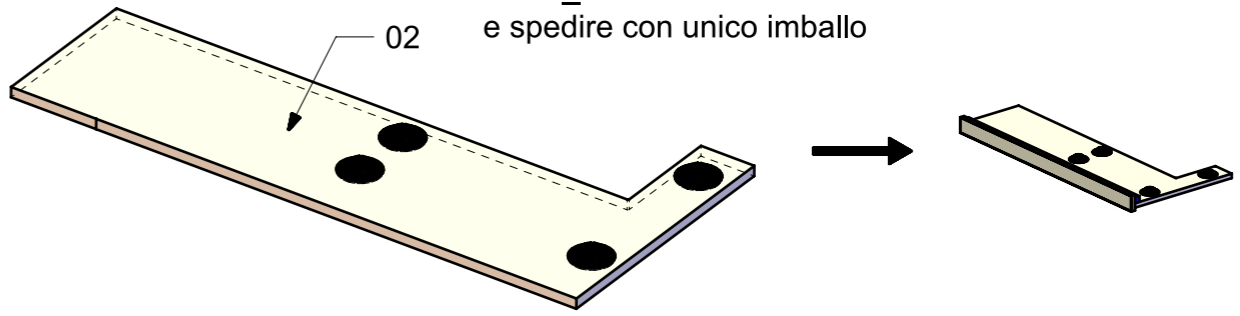

FERRAMENTA	QTY
FITLOCK M_MASCHERPA_3MM_6020202101	13

VERNICIATURA LASTRA/LACCATI:  
 ● = VERNICIARE 1 LATO + FILI RASATI O BORDATI      NESSUN SIMBOLO = VERNICIARE 2 LATI + FILI RASATI O BORDATI

LOCALE	CODICE	DESCRIZIONE COMPONENTE	FINITURA	Q.TA
SALONE	MD299_L01_SQ01	CIELINO PLENUM SX POPPA	LACCATO BIANCO 9010	1

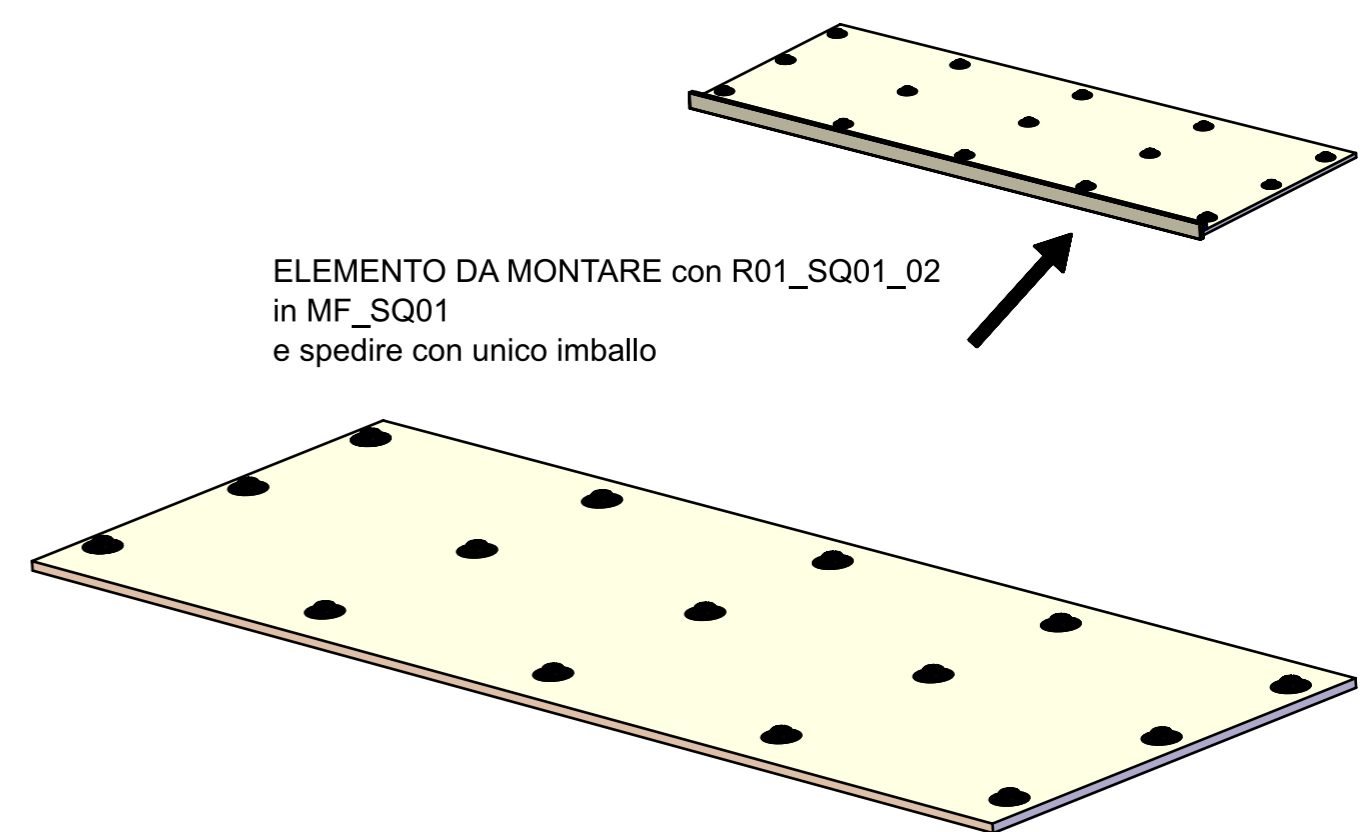
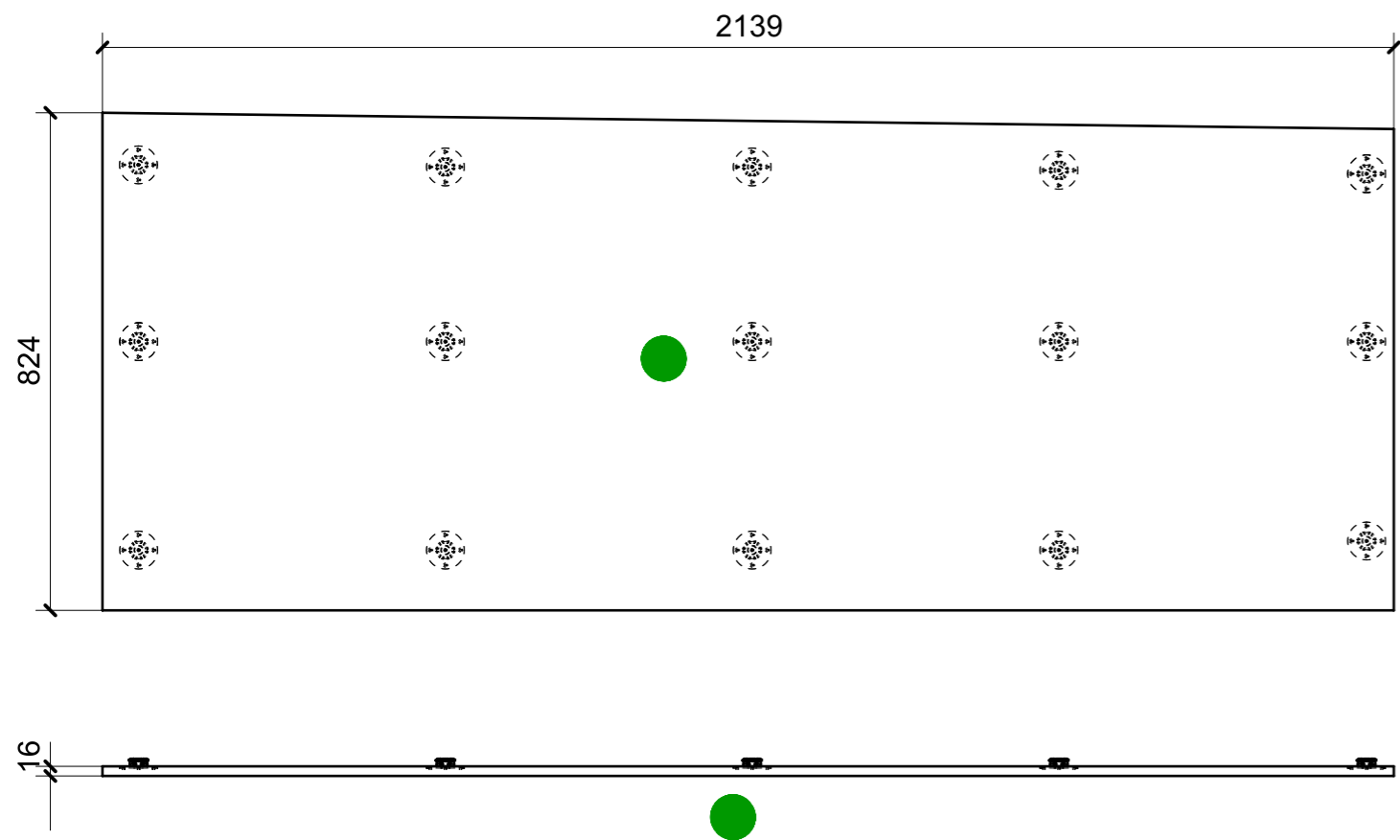

ELEMENTO DA MONTARE con R01\_SQ01\_02  
in MF\_SQ01  
e spedire con unico imballo

FERRAMENTA	QTY
FITLOCK M_MASCHERPA_3MM_6020202101	15

VERNICIATURA LASTRA/LACCATI:  
● = VERNICIARE 1 LATO + FILI RASATI O BORDATI      NESSUN SIMBOLO = VERNICIARE 2 LATI + FILI RASATI O BORDATI

LOCALE	CODICE	DESCRIZIONE COMPONENTE	FINITURA	Q.TA
SALONE	MD299_L01_SR01	TRAVERSA INGRESSO SOFFITTO	LACCATO BIANCO 9010	1

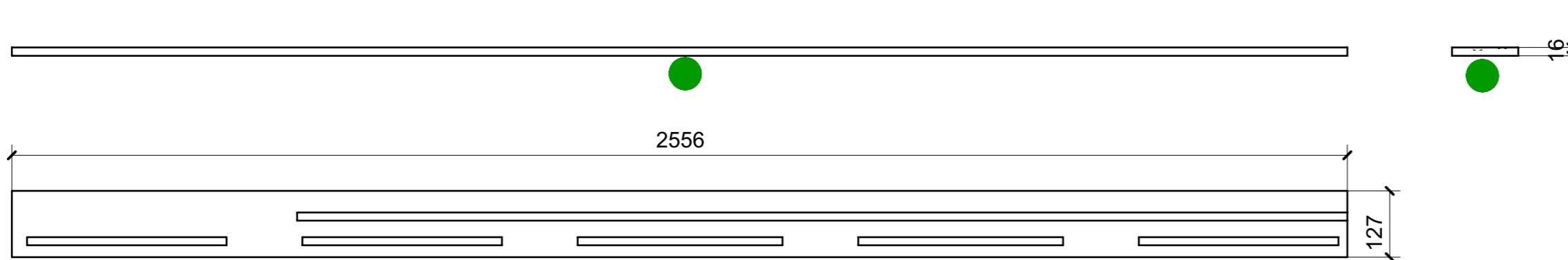

ELEMENTO DA MONTARE  
 con R01\_SR01\_01; SR01\_02-->07  
 in MF\_SR01  
 e spedire con unico imballo

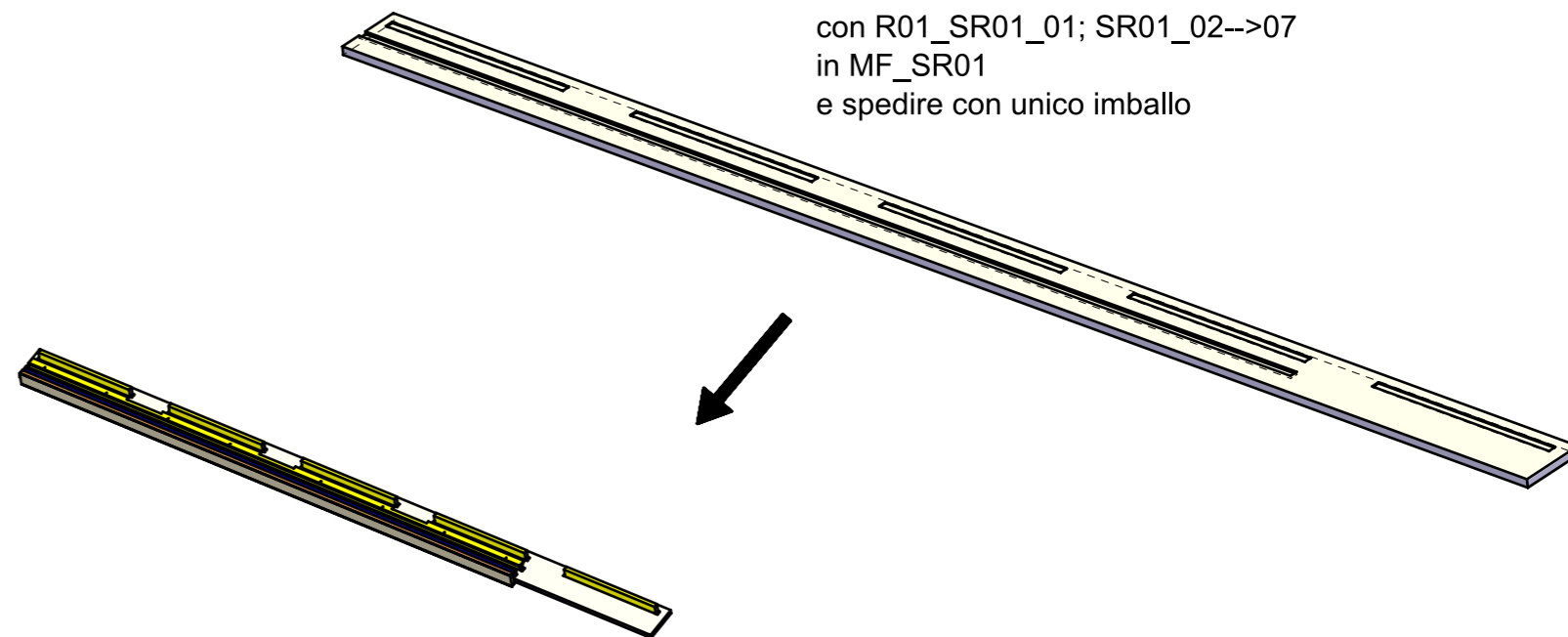

VERNICIATURA LASTRA/LACCATI:

● = VERNICIARE 1 LATO + FILI RASATI O BORDATI

NESSUN SIMBOLO = VERNICIARE 2 LATI + FILI RASATI O BORDATI

LOCALE	CODICE	DESCRIZIONE COMPONENTE	FINITURA	Q.TA
SALONE	MD299_L01_SS01	CIELINO PLENUM DX POPPA	LACCATO BIANCO 9010	1

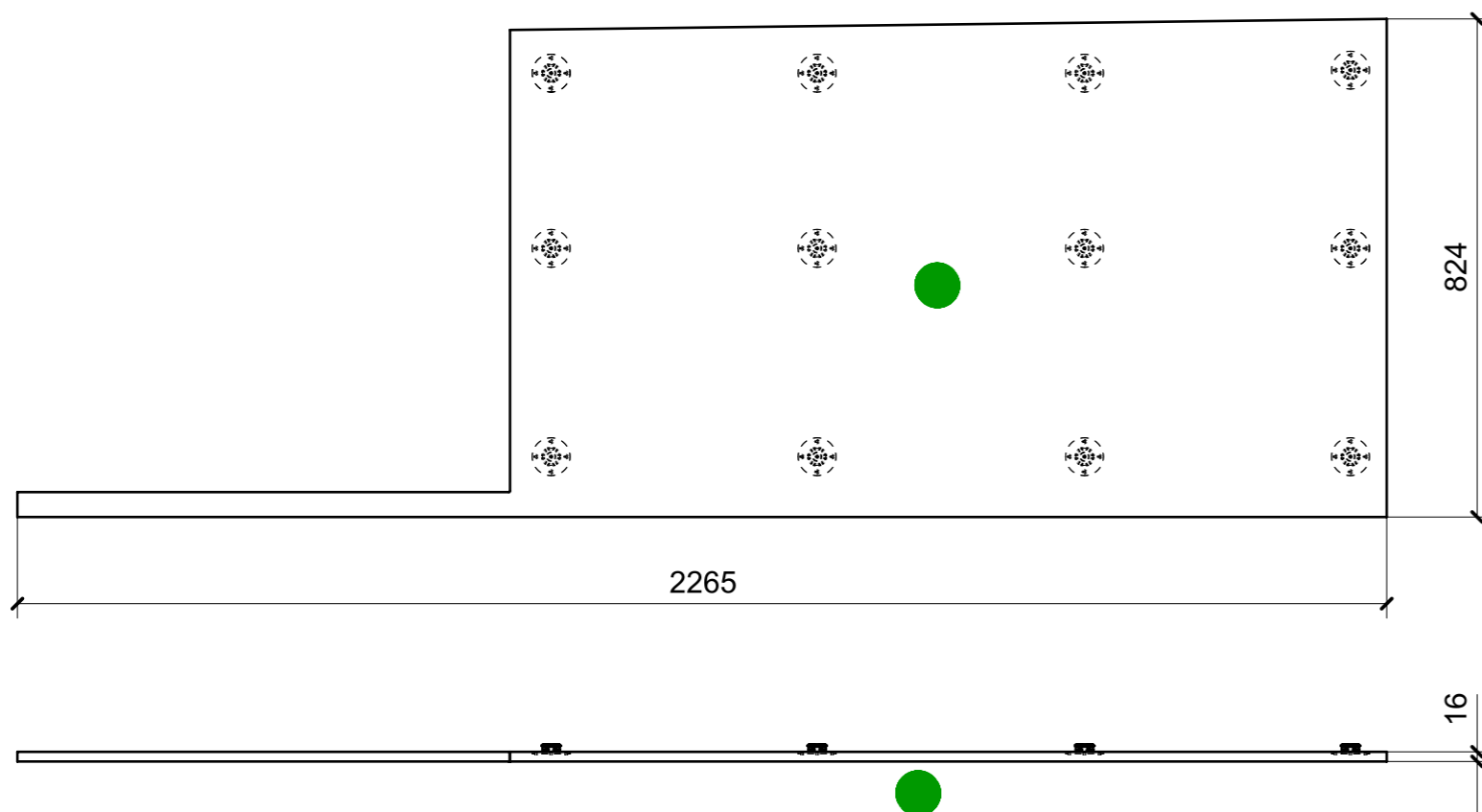

ELEMENTO DA MONTARE con R01\_SS01\_01  
in MF\_SS01  
e spedire con unico imballo

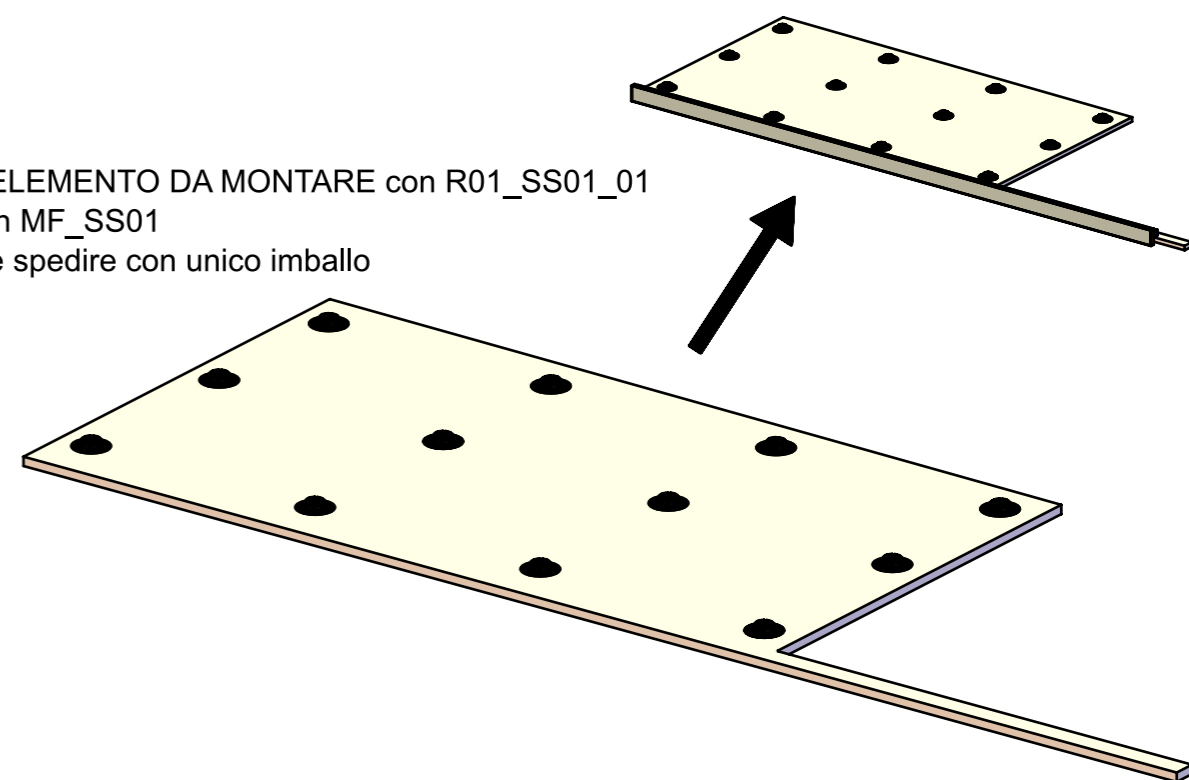

FERRAMENTA	QTY
FITLOCK M_MASCHERPA_3MM_6020202101	12

VERNICIATURA LASTRA/LACCATI:

● = VERNICIARE 1 LATO + FILI RASATI O BORDATI

NESSUN SIMBOLO = VERNICIARE 2 LATI + FILI RASATI O BORDATI

LOCALE	CODICE	DESCRIZIONE COMPONENTE	FINITURA	Q.TA
SALONE	MD299_L01_ST01	CIELINO PLENUM DX CENTRO MURATA	LACCATO BIANCO 9010	1

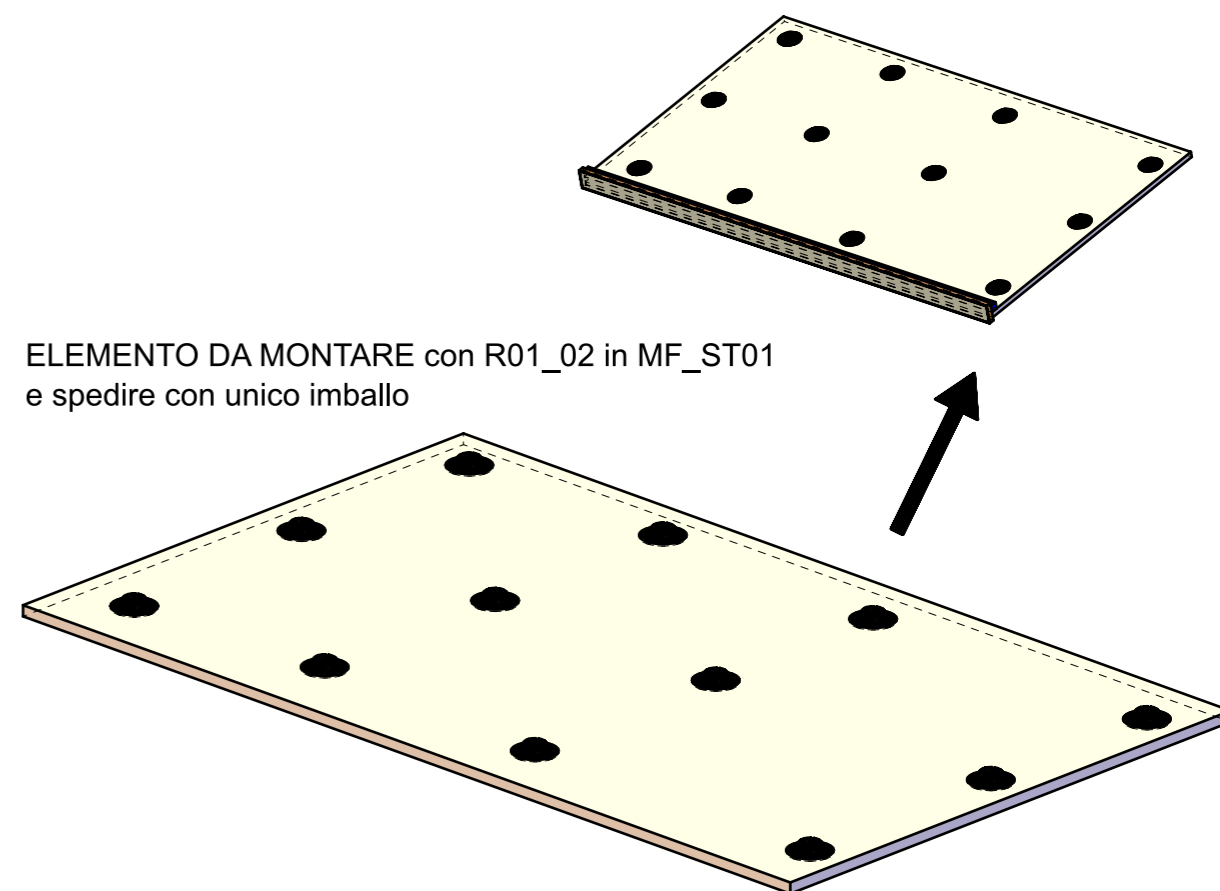
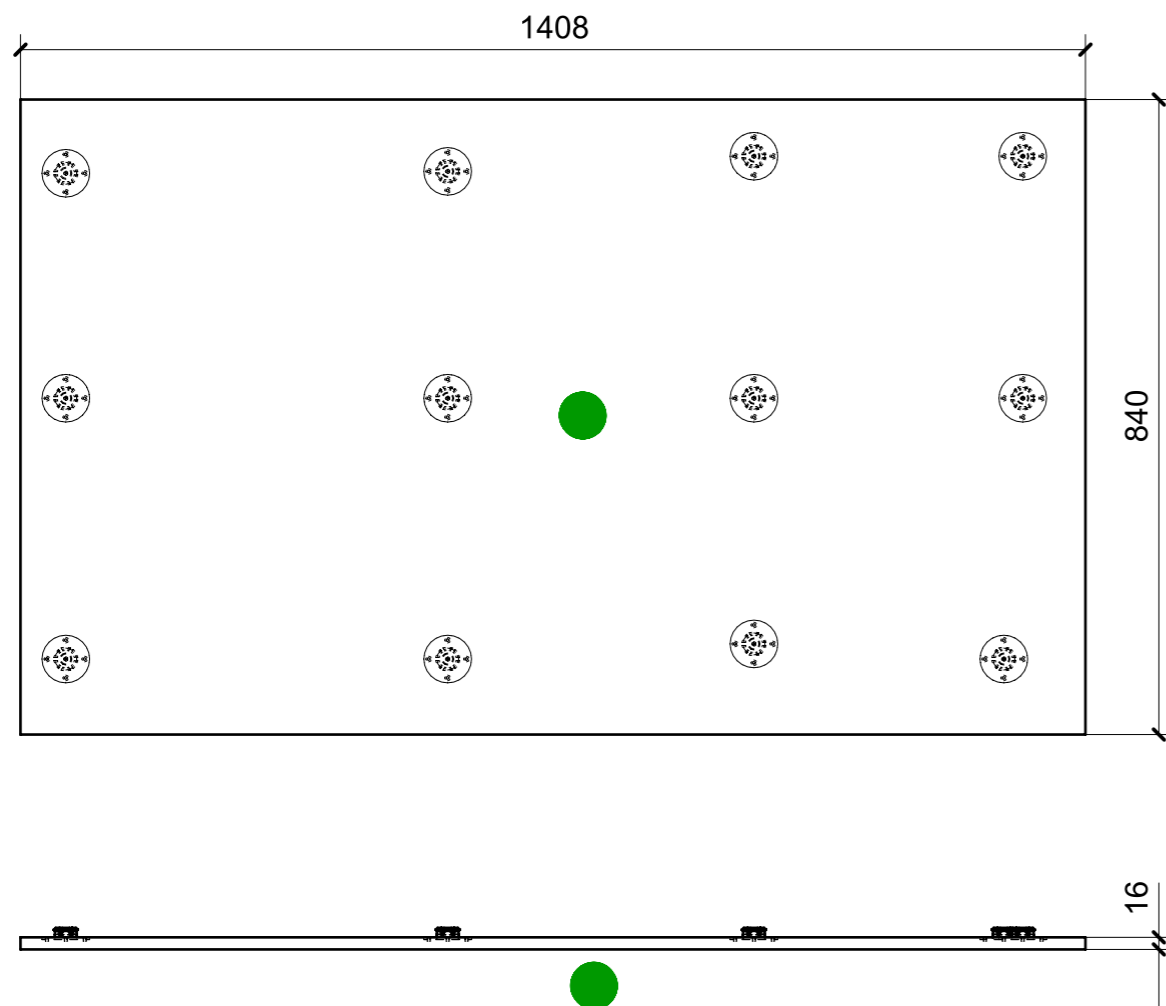

FERRAMENTA	QTY
FITLOCK M_MASCHERPA_3MM_6020202101	12

VERNICIATURA LASTRA/LACCATI:

● = VERNICIARE 1 LATO + FILI RASATI O BORDATI

NESSUN SIMBOLO = VERNICIARE 2 LATI + FILI RASATI O BORDATI

LOCALE	CODICE	DESCRIZIONE COMPONENTE	FINITURA	Q.TA
SALONE	MD299_L01_SW01	CIELINO PLENUM DX PRUA	LACCATO BIANCO 9010	1

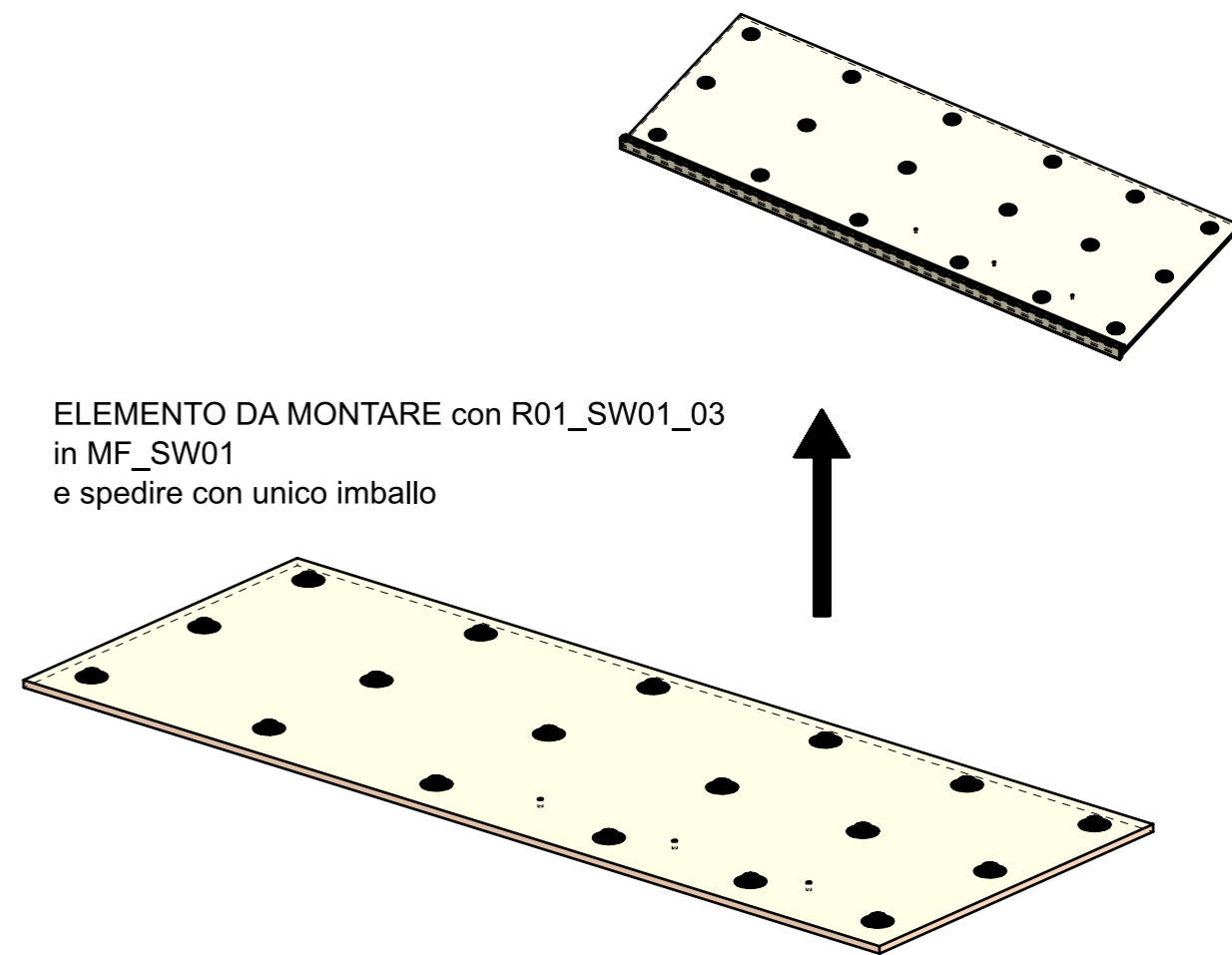
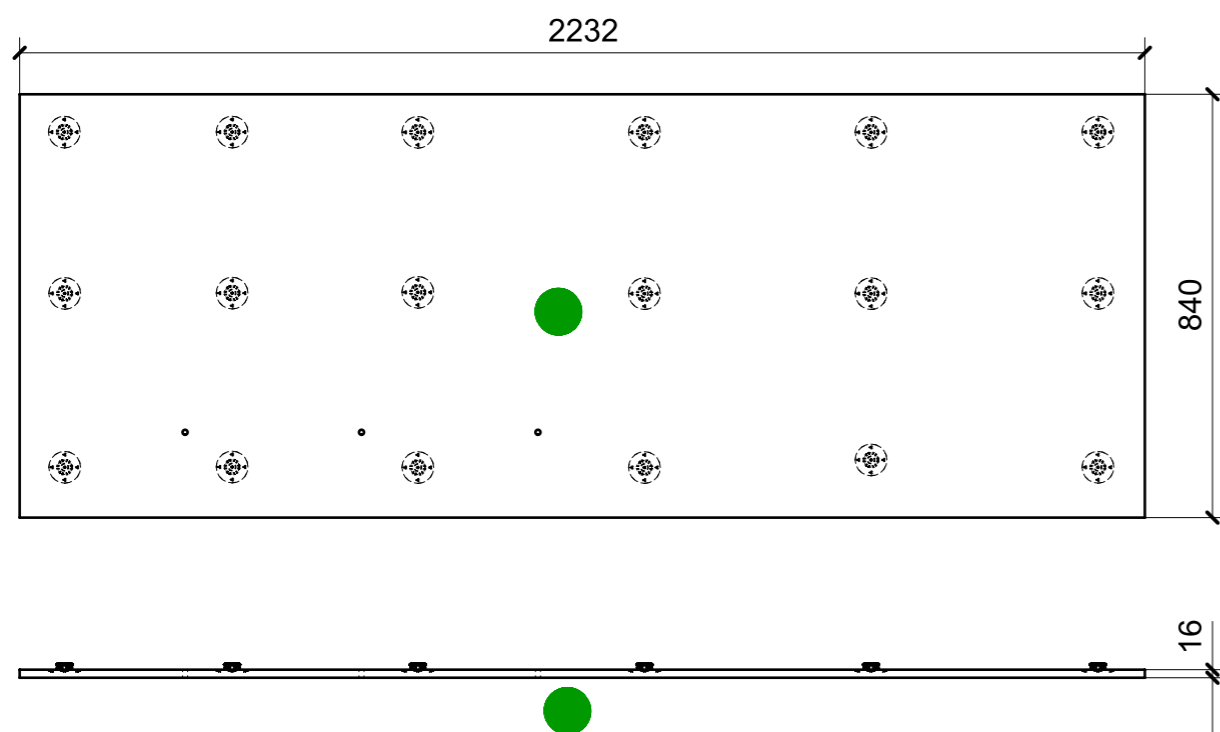

ELEMENTO DA MONTARE con R01\_SW01\_03  
in MF\_SW01  
e spedire con unico imballo

FERRAMENTA	QTY
FITLOCK M_MASCHERPA_3MM_6020202101	18

VERNICIATURA LASTRA/LACCATI:

● = VERNICIARE 1 LATO + FILI RASATI O BORDATI

NESSUN SIMBOLO = VERNICIARE 2 LATI + FILI RASATI O BORDATI

LOCALE	CODICE	DESCRIZIONE COMPONENTE	FINITURA	Q.TA
SALONE	MD299_L01_SXX01	FINITI CIELINO PLENUM SX PRUA_STD VAR 1	LACCATO BIANCO 9010	1

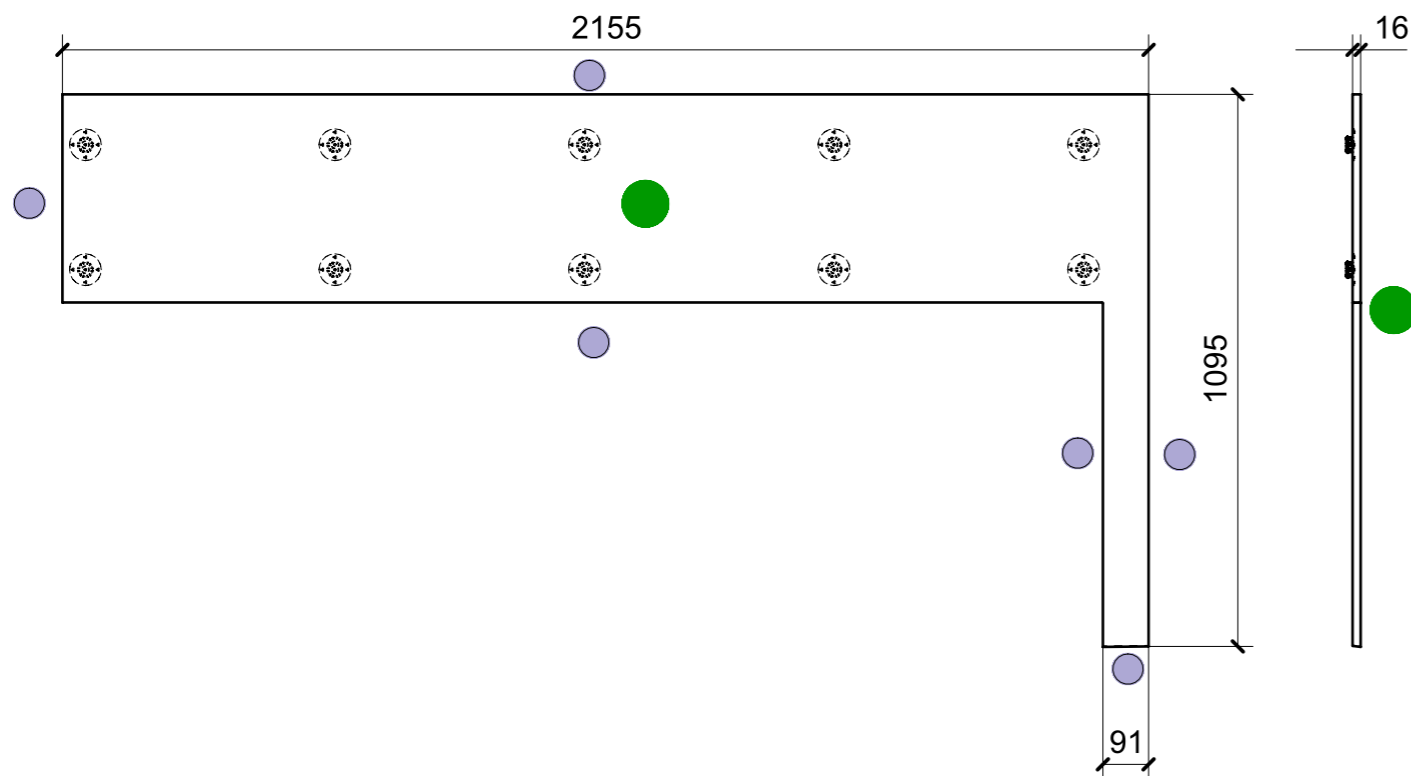

ELEMENTO DA MONTARE con R01\_04  
in MF\_SXX01  
e spedire con unico imballo

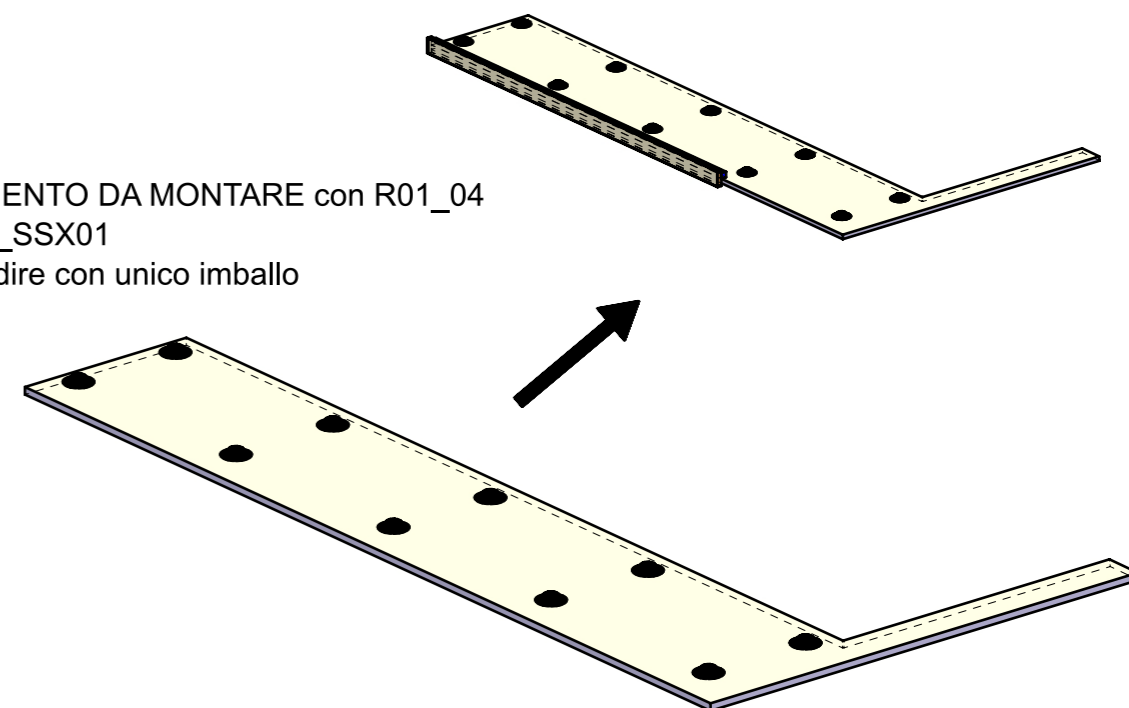

FERRAMENTA	QTY
FITLOCK M_MASCHERPA_3MM_6020202101	10

● = FILI RASATI

● = VERNICIARE 1 LATO + FILI RASATI O BORDATI

NESSUN SIMBOLO = VERNICIARE 2 LATI + FILI RASATI O BORDATI

LOCALE	CODICE	DESCRIZIONE COMPONENTE	FINITURA	Q.TA
SALONE	MD299_L01_SXX01	FINITI CIELINO PLENUM SX PRUA_STD VAR 2	LACCATO BIANCO 9010	1

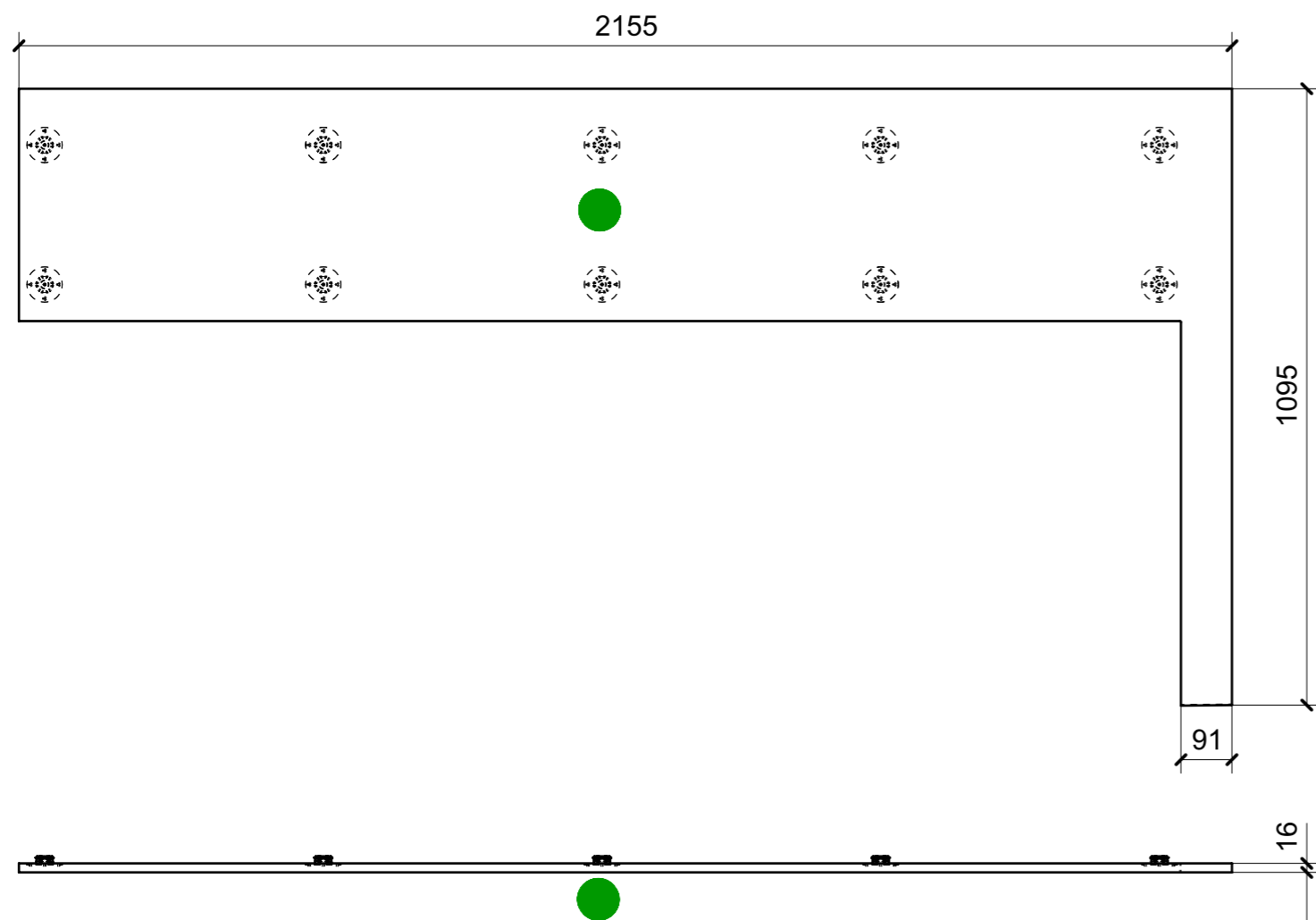

ELEMENTO DA MONTARE con R01\_SXX01\_02/03  
in MF\_SXX01  
e spedire con unico imballo

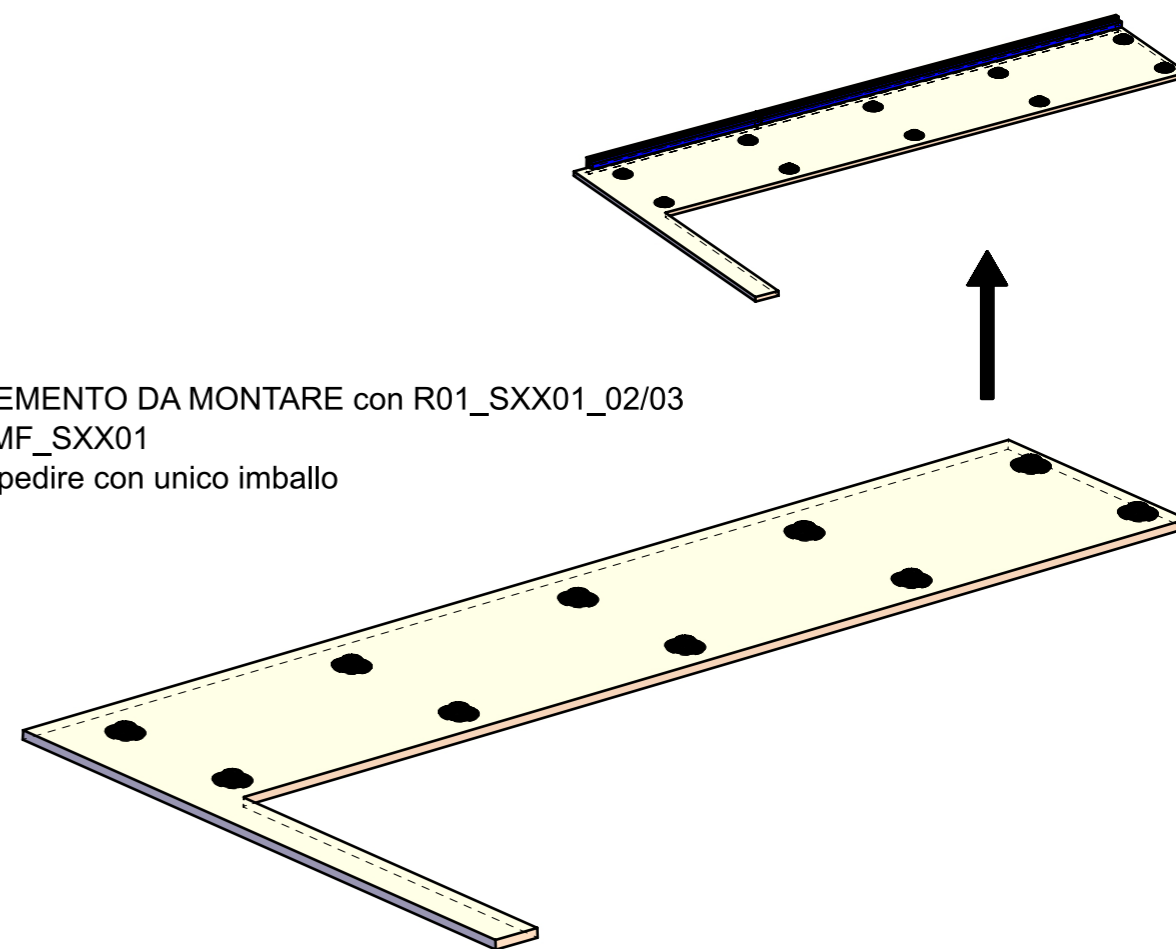

FERRAMENTA	QTY
FITLOCK M_MASCHERPA_3MM_6020202101	10

VERNICIATURA LASTRA/LACCATI:

● = VERNICIARE 1 LATO + FILI RASATI O BORDATI

NESSUN SIMBOLO = VERNICIARE 2 LATI + FILI RASATI O BORDATI

LOCALE	CODICE	DESCRIZIONE COMPONENTE	FINITURA	Q.TA
SALONE	MD299_L01_SY01	CIELINO CENTRALE	LACCATO BIANCO 9010 spessore 16mm	1

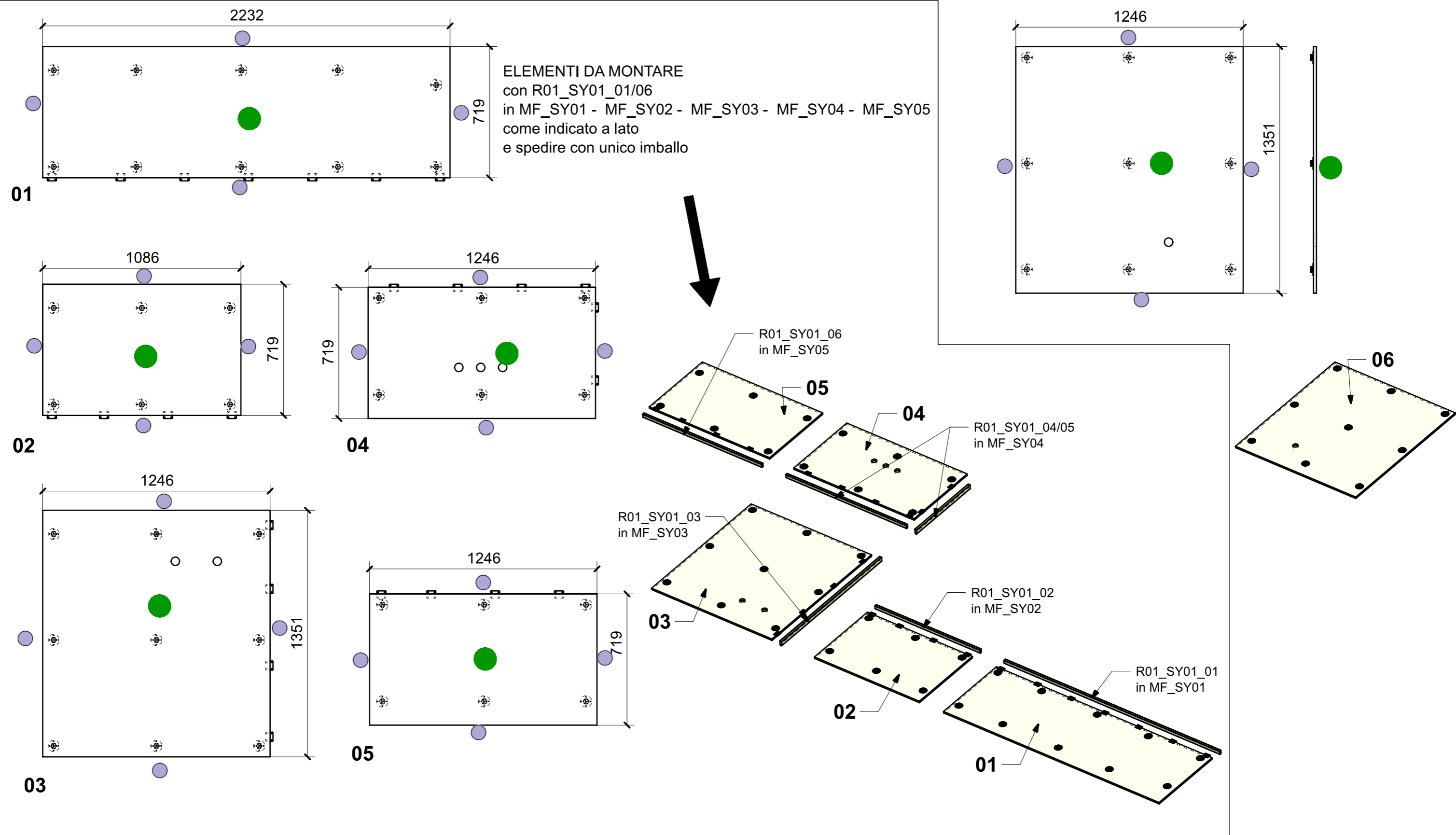

FERRAMENTA	QTY
PIASTRINA SP.1MM 50X40_FBC_ART_264 Z	25
FITLOCK M_MASCHERPA_3MM_6020202101	46

LOCALE	CODICE	DESCRIZIONE COMPONENTE	FINITURA	Q.TA
SALONE	MD299_L01_SSY01	FINITI CIELINO CENTRALE_STD VAR 1	LACCATO BIANCO 9010	1

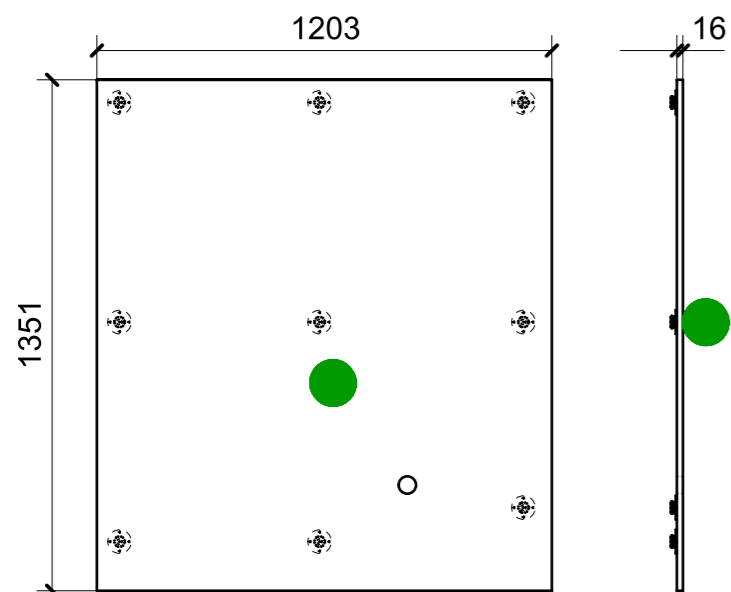

01

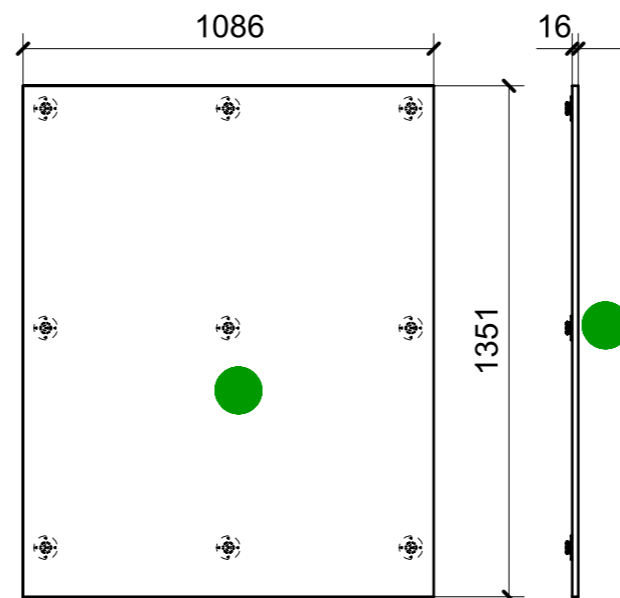

03

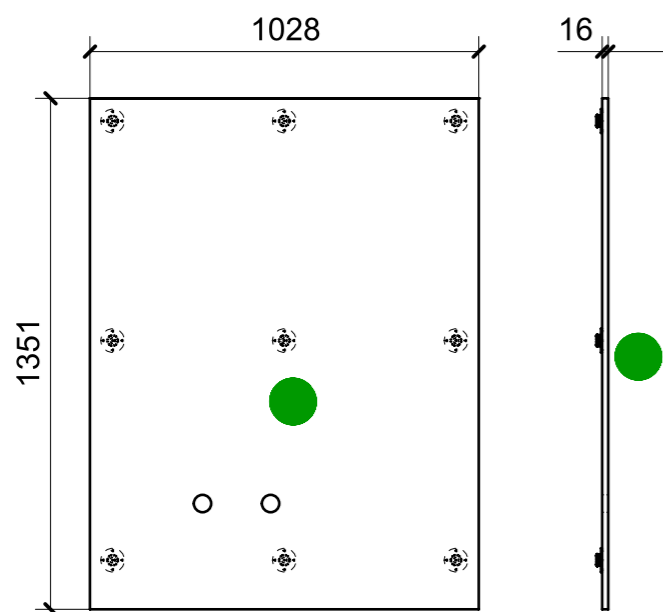

02

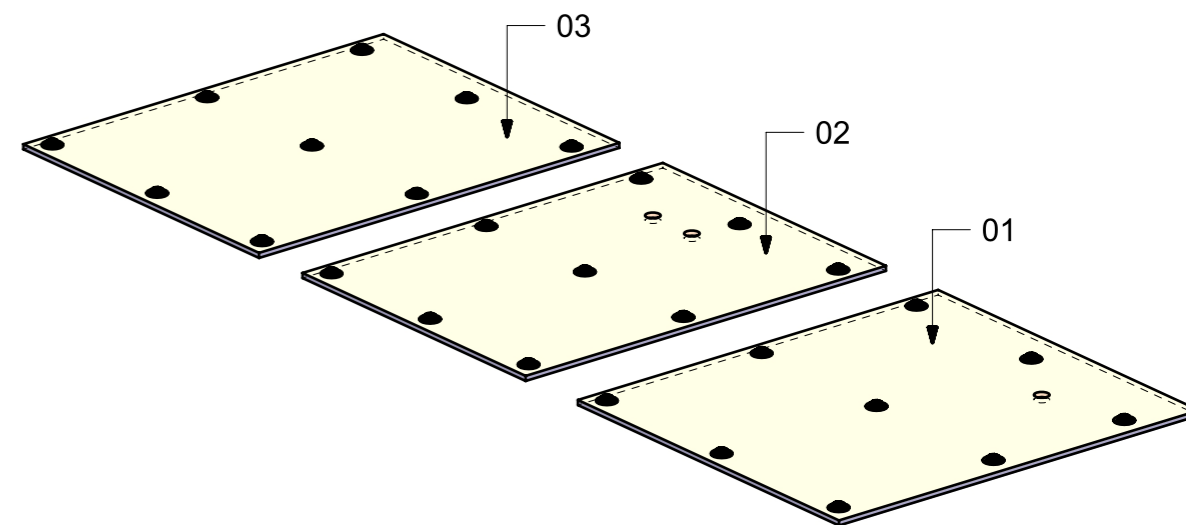

FERRAMENTA	QTY
FITLOCK M_MASCHERPA_3MM_6020202101	27

VERNICIATURA LASTRA/LACCATI:

● = VERNICIARE 1 LATO + FILI RASATI O BORDATI

NESSUN SIMBOLO = VERNICIARE 2 LATI + FILI RASATI O BORDATI

LOCALE	CODICE	DESCRIZIONE COMPONENTE	FINITURA	Q.TA
SALONE	MD299_L01_SYY01	FINITI CIELINO CENTRALE_STD VAR 2	LACCATO BIANCO 9010	1

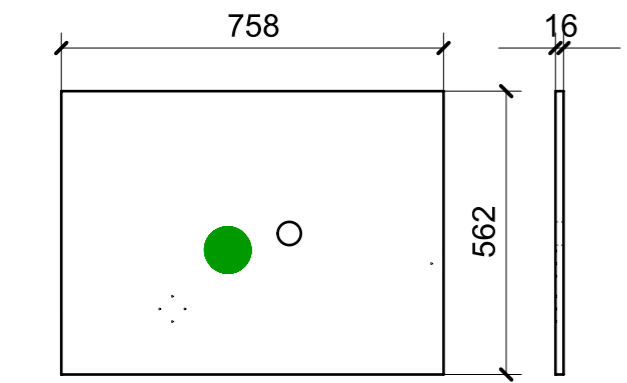

01

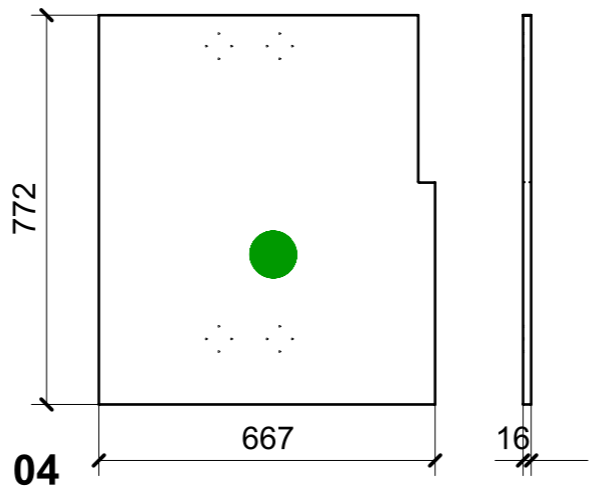

04

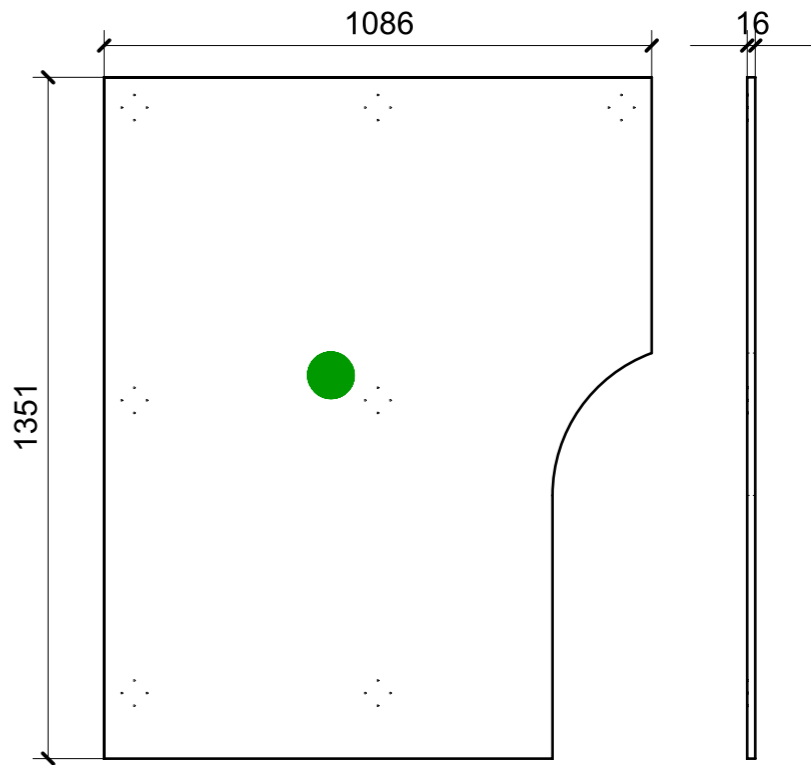

06

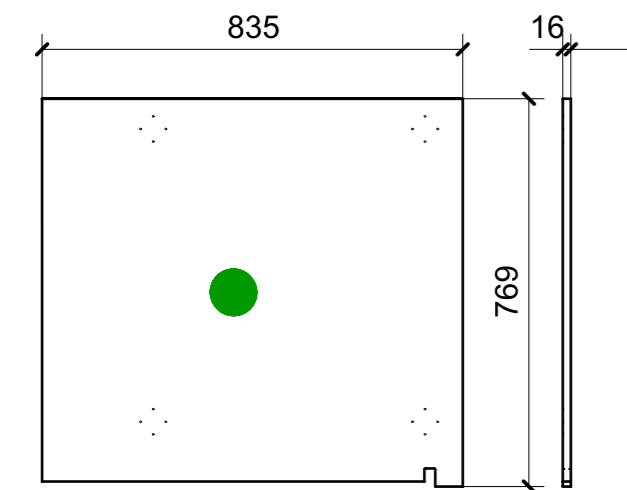

02

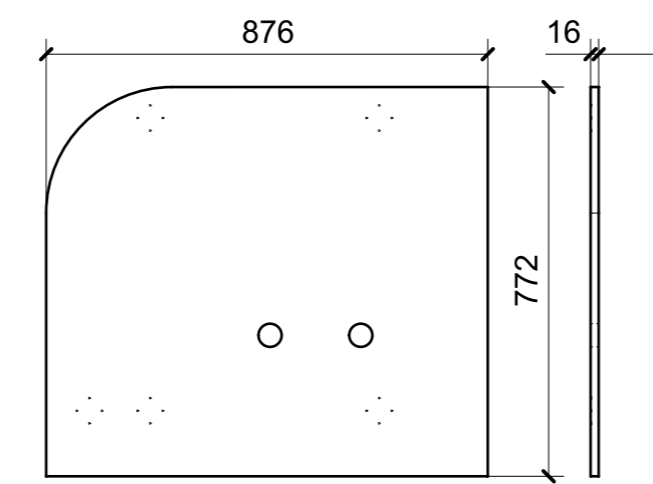

05

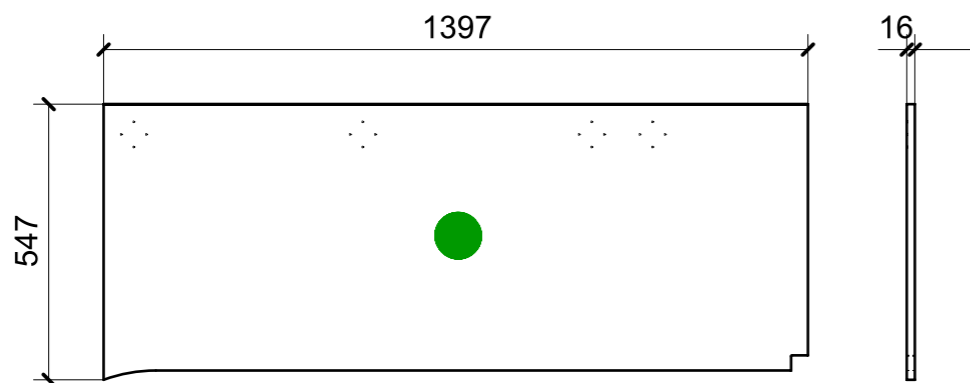
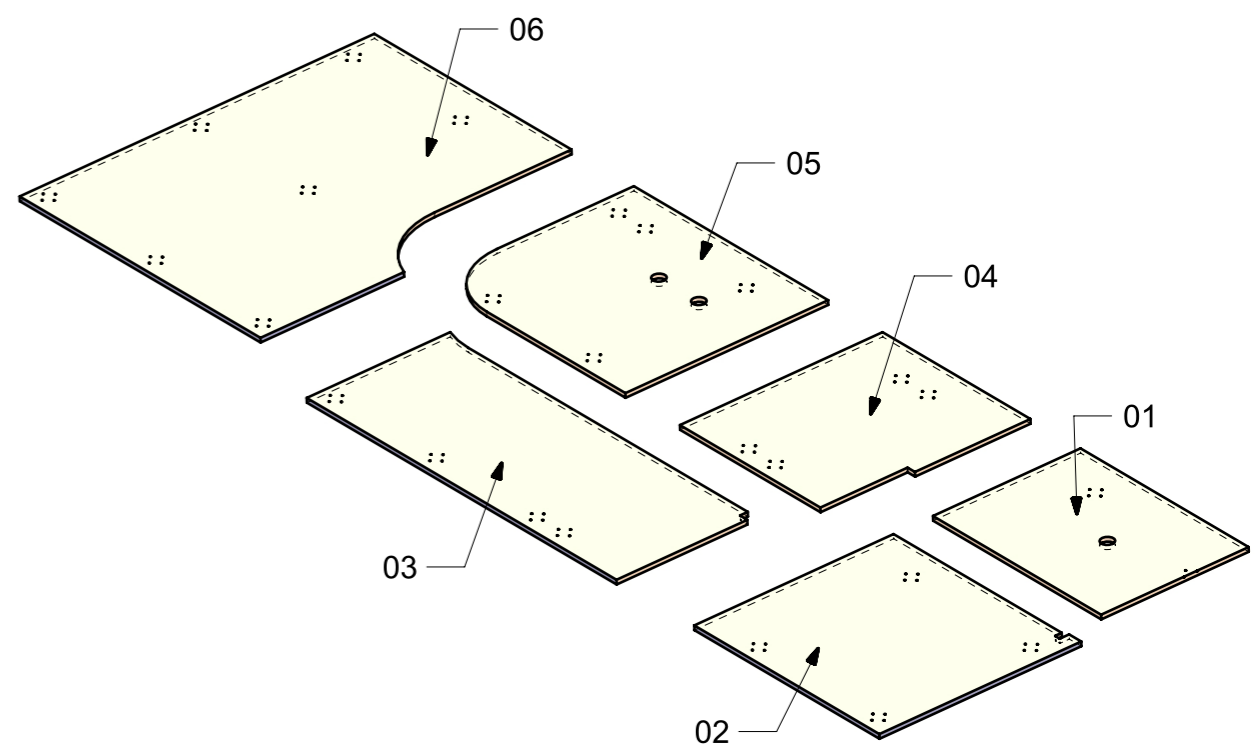

03

VERNICIATURA LASTRA/LACCATI:

● = VERNICIARE 1 LATO + FILI RASATI O BORDATI

NESSUN SIMBOLO = VERNICIARE 2 LATI + FILI RASATI O BORDATI

LOCALE	CODICE	DESCRIZIONE COMPONENTE	FINITURA	Q.TA
SALONE	MD299_L01_SZ01	CIELINO FRONTEMARCIA_STD VAR 1	LACCATO BIANCO 9010	1

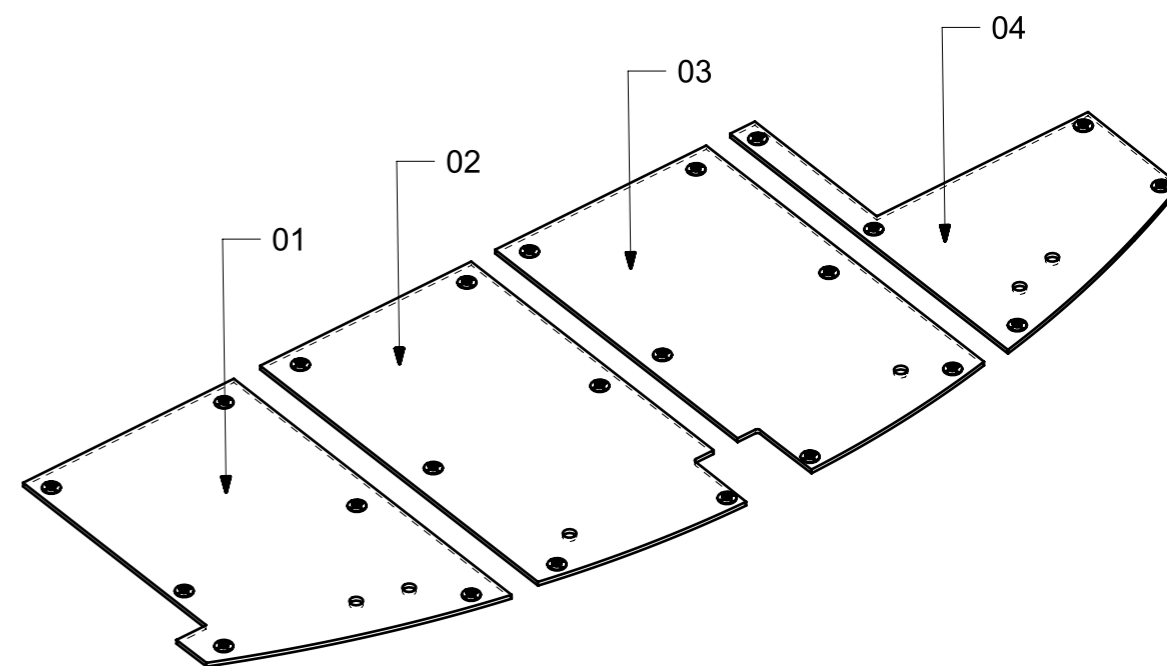
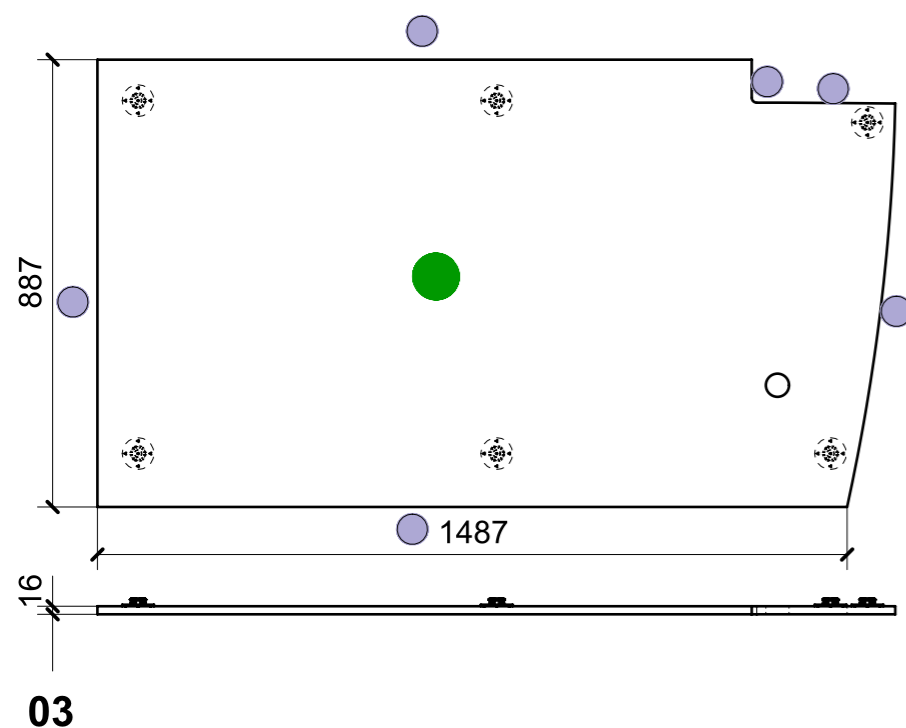
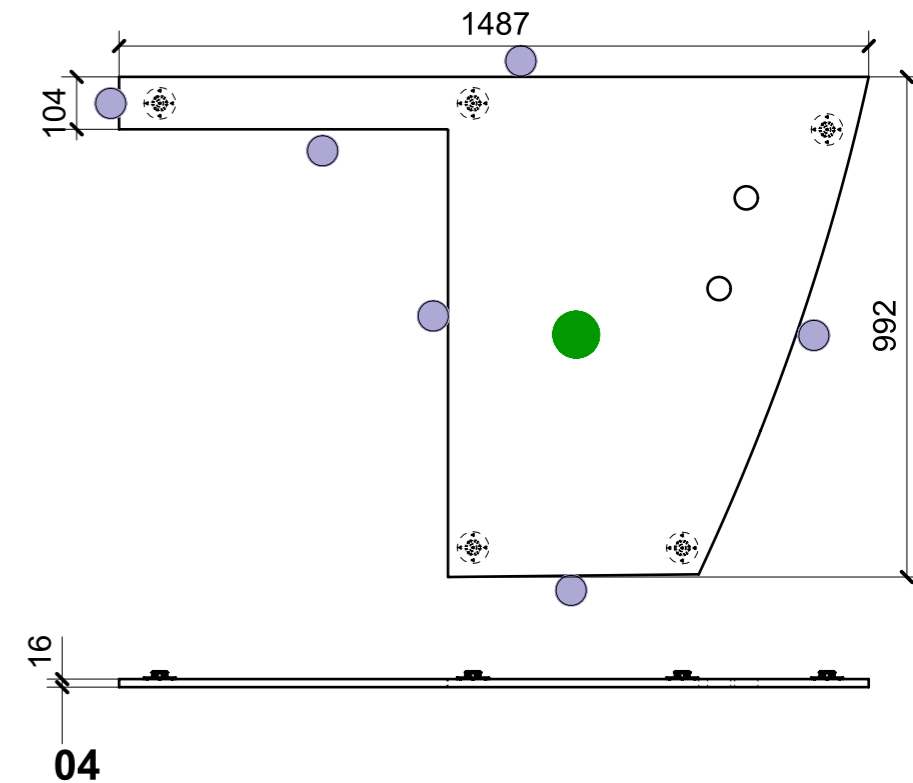
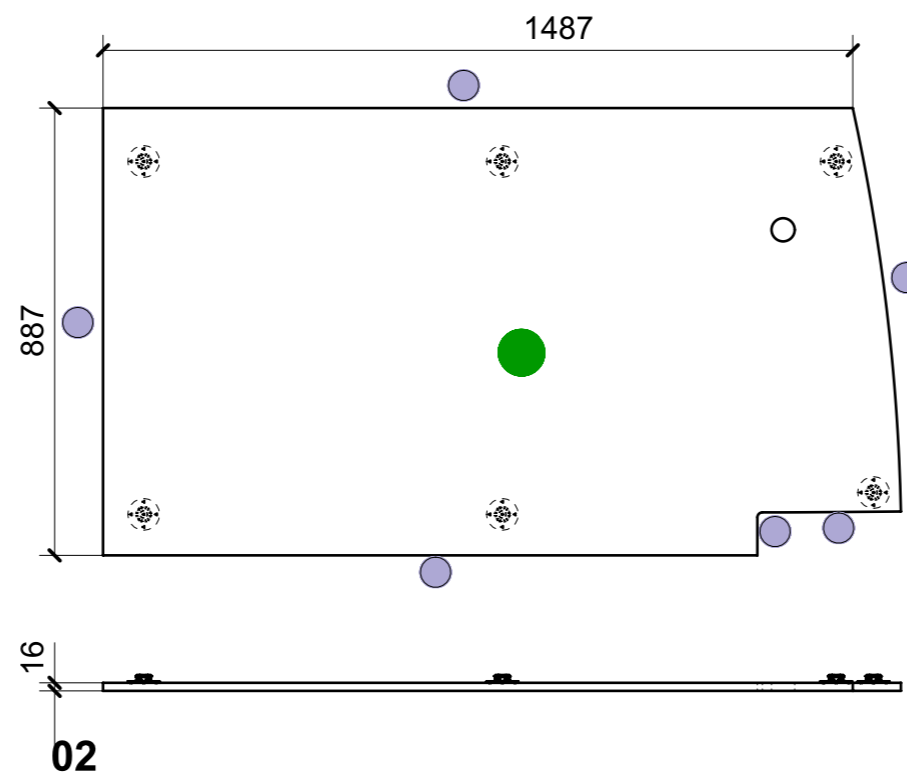
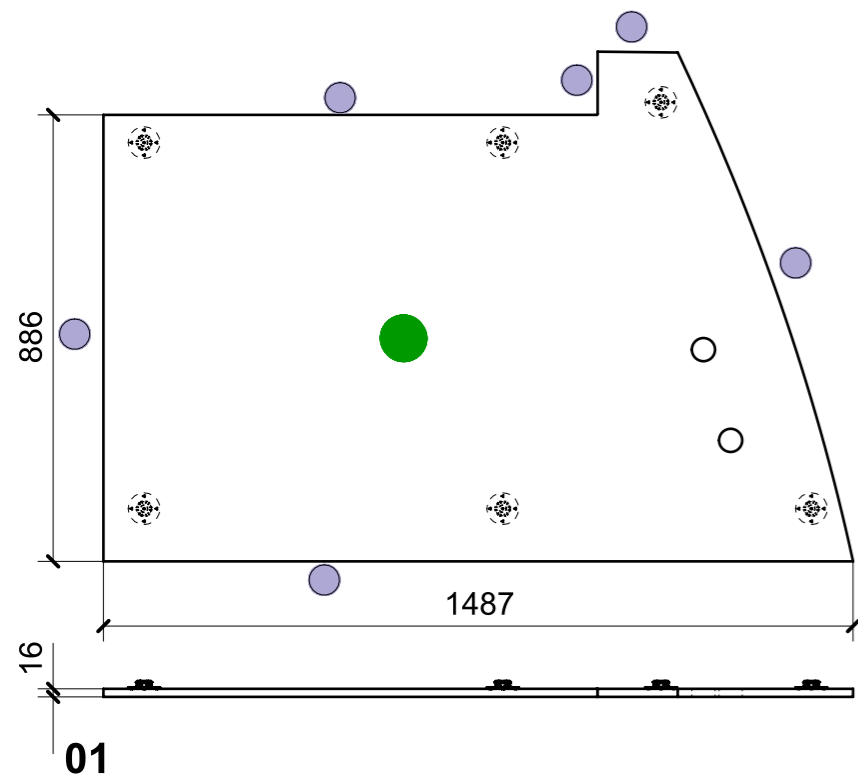

FERRAMENTA	QTY
FITLOCK M_MASCHERPA_3MM_6020202101	23

VERNICIATURA LASTRA/LACCATI:

● = FILI RASATI

● = VERNICIARE 1 LATO + FILI RASATI O BORDATI

NESSUN SIMBOLO = VERNICIARE 2 LATI + FILI RASATI O BORDATI

LOCALE	CODICE	DESCRIZIONE COMPONENTE	FINITURA	Q.TA
SALONE	MD299_L01_SSZ01	CIELINO FRONTEMARCIA_STD VAR 2	LACCATO BIANCO 9010	1

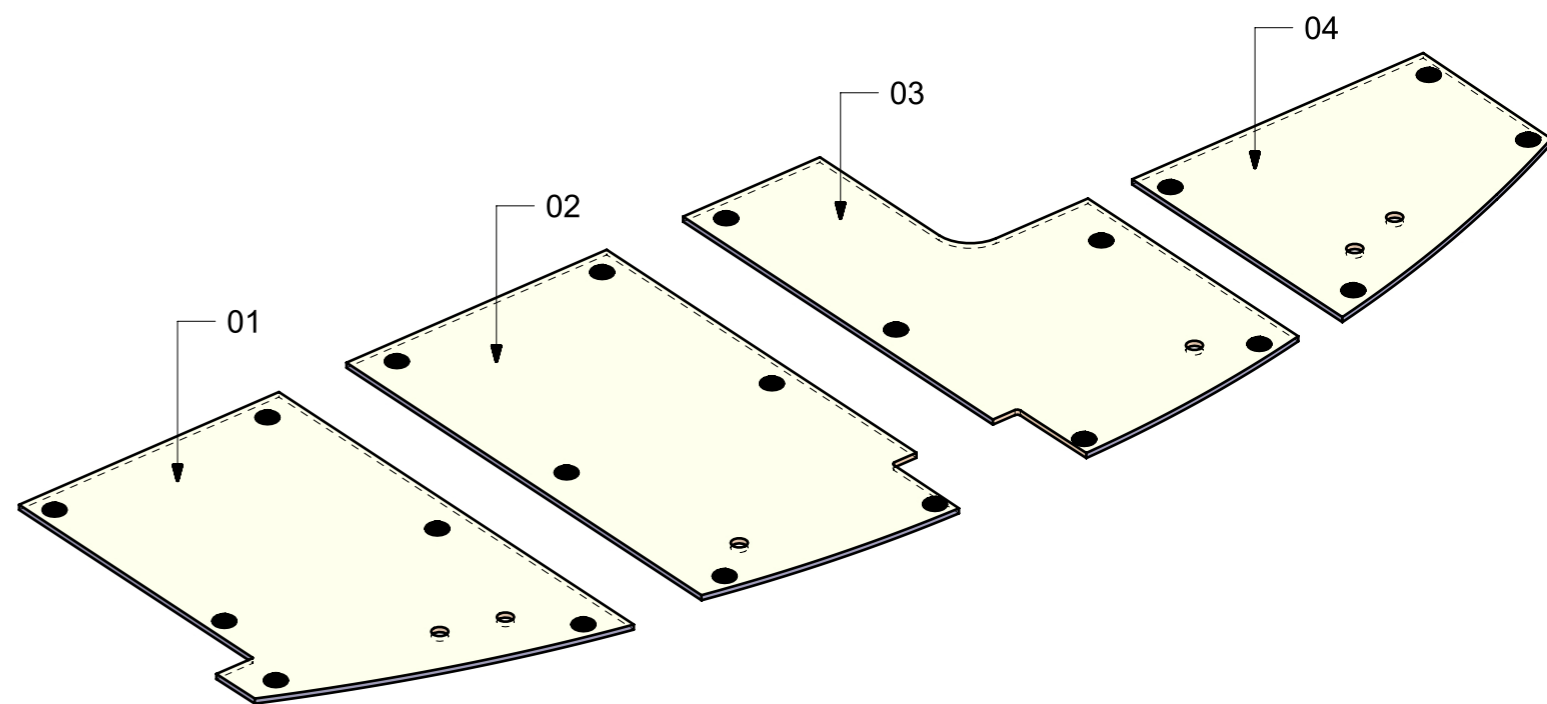
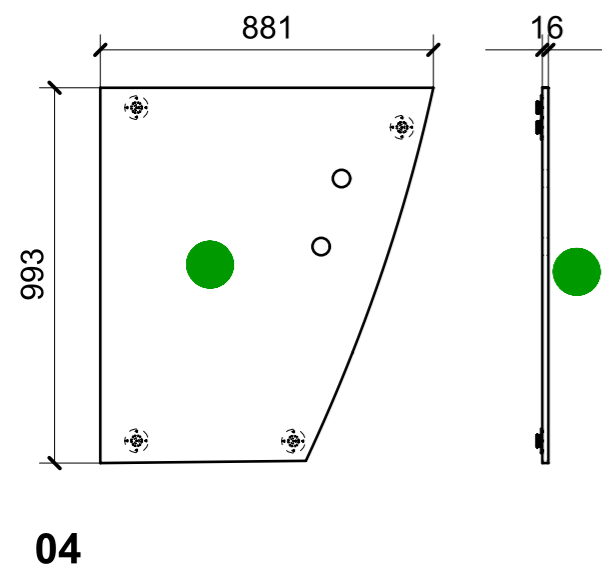
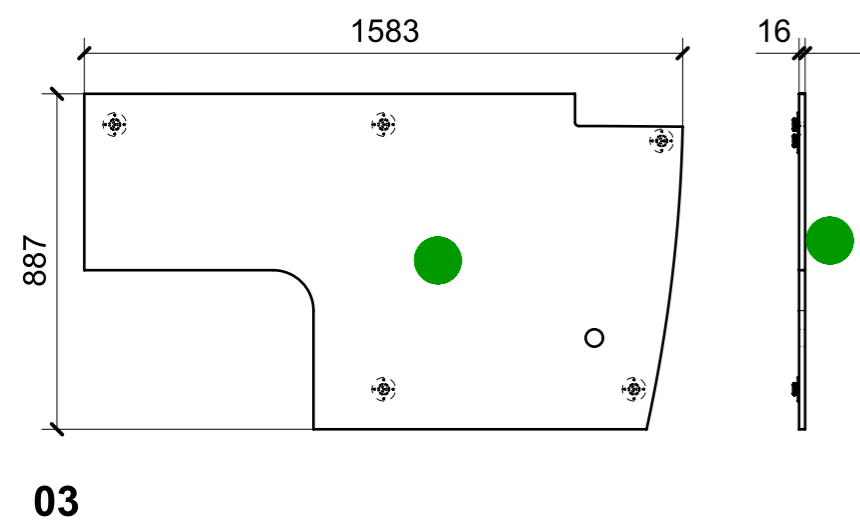
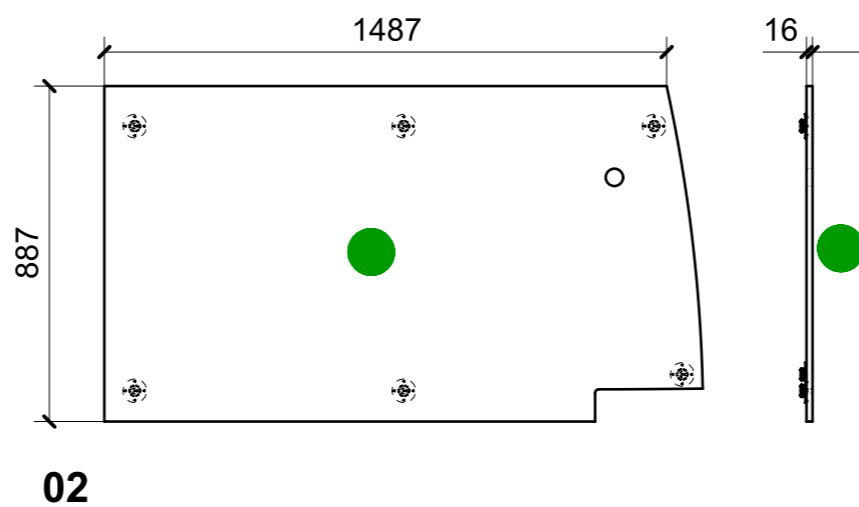
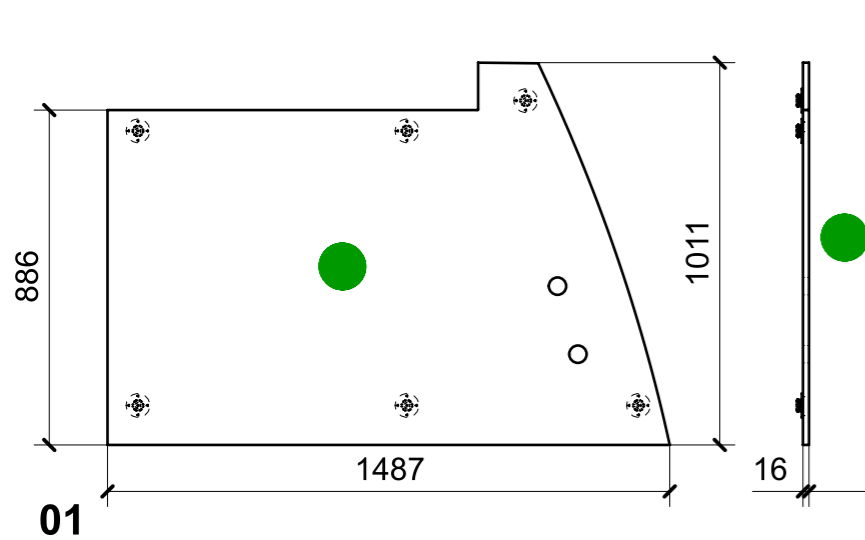

FERRAMENTA	QTY
FITLOCK M_MASCHERPA_3MM_6020202101	21

VERNICIATURA LASTRA/LACCATI:

● = VERNICIARE 1 LATO + FILI RASATI O BORDATI

NESSUN SIMBOLO = VERNICIARE 2 LATI + FILI RASATI O BORDATI

LOCALE	CODICE	DESCRIZIONE COMPONENTE	FINITURA	Q.TA
SALONE	MD299_L01_SSC01	TAVOLO HI-LOW_STD VAR 2	LACCATO NERO	1

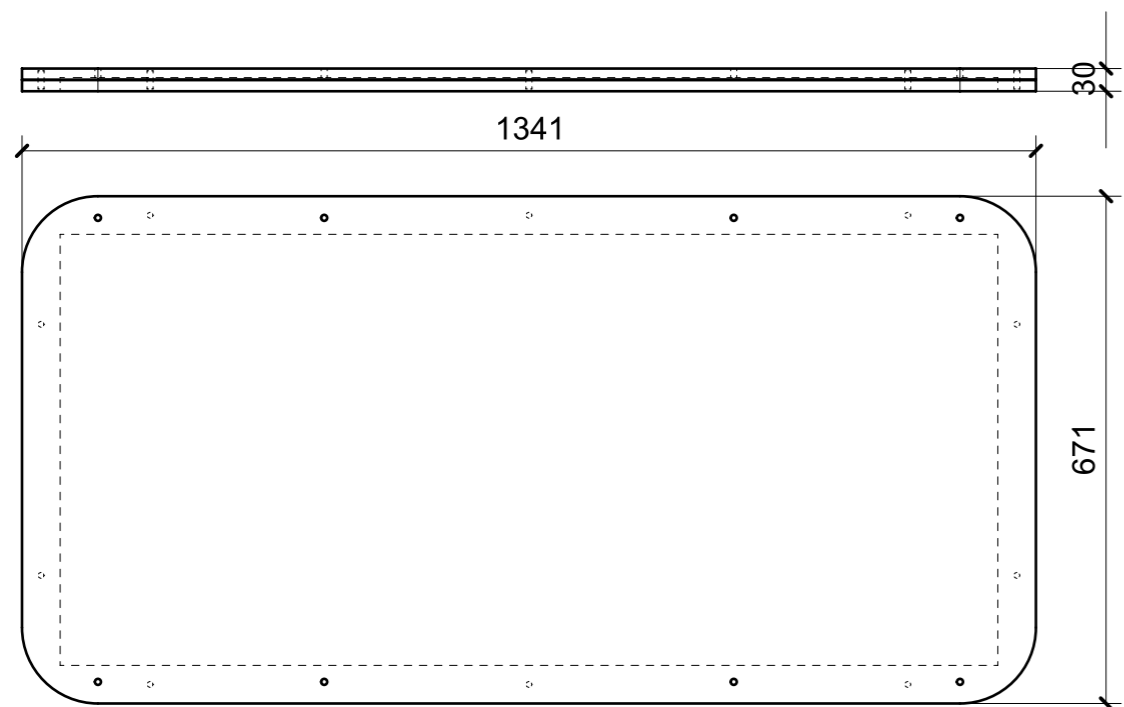

01

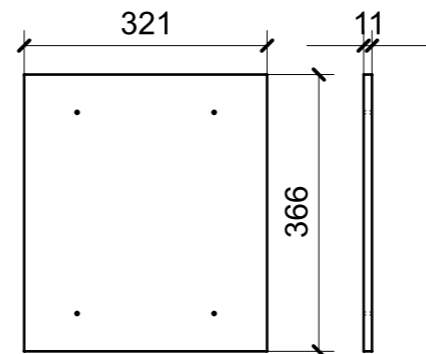

03

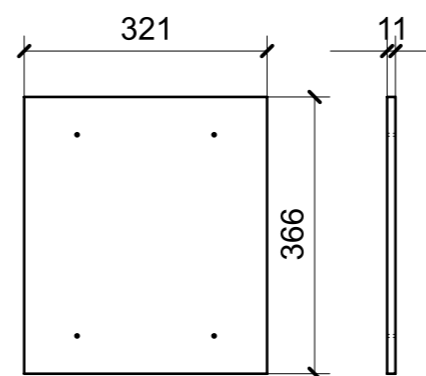

05

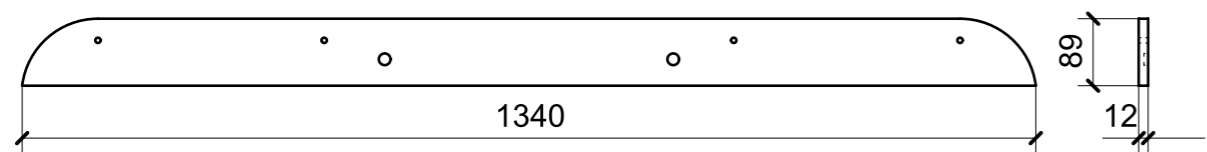
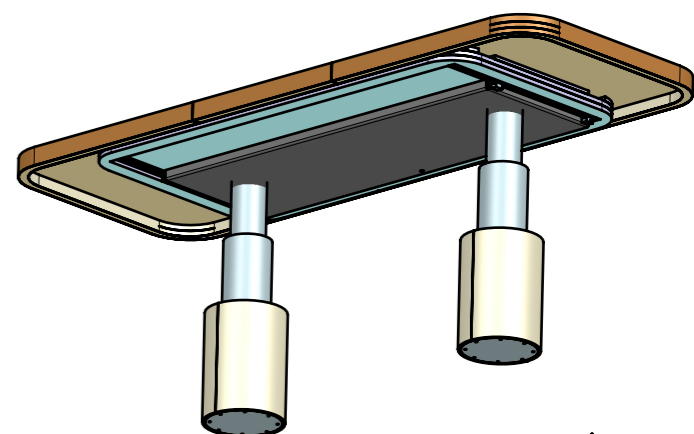

06

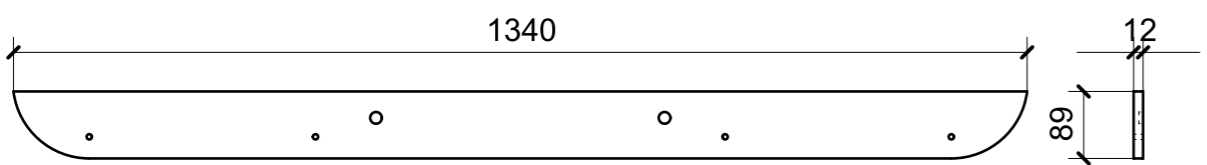

02

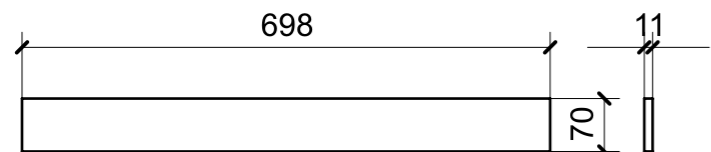

04

ELEMENTI DA MONTARE  
 con R01\_SSC01\_01/04 - A01\_SSC01\_01 - X01\_SSC01\_01/04  
 in MF\_SSC01  
 e spedire con unico imballo

