

LOCALE	CODICE	DESCRIZIONE COMPONENTE	FINITURA	Q.TA
CABINA ARMATORE	MD299_A01_AL01	TAVOLINO A RIBALTA MURATA DX_OPT	ACCIAIO	1

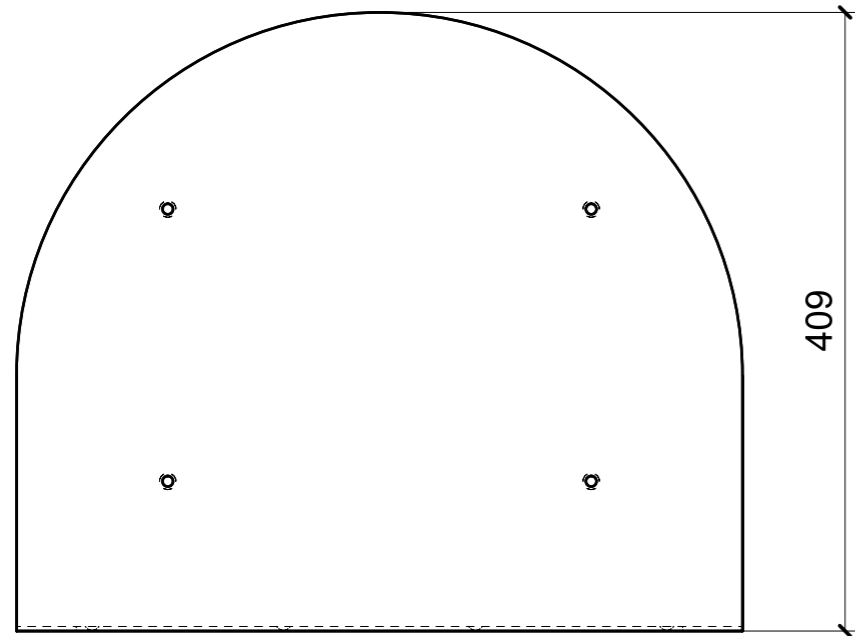

A05 - ACCIAIO VERNICIATO NERO

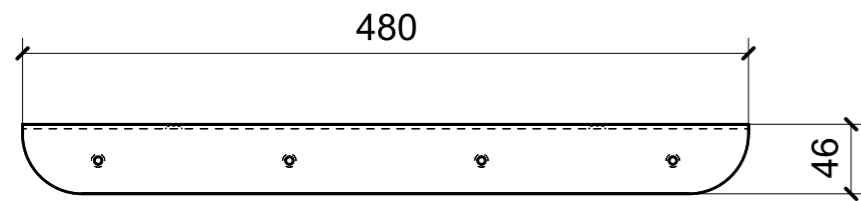
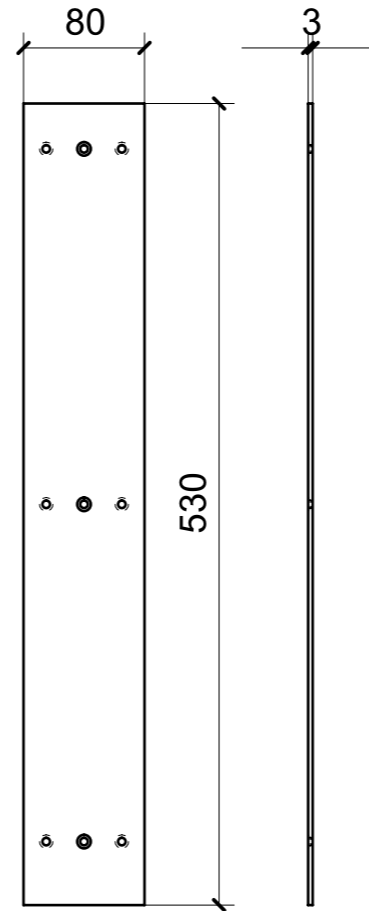

A06 - ACCIAIO GREZZO

ELEMENTO DA MONTARE CON R01_AL01_06
IN MF_AL02 e spedire con un unico imballo

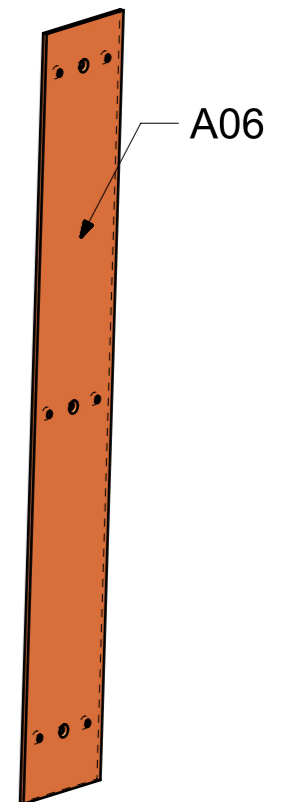
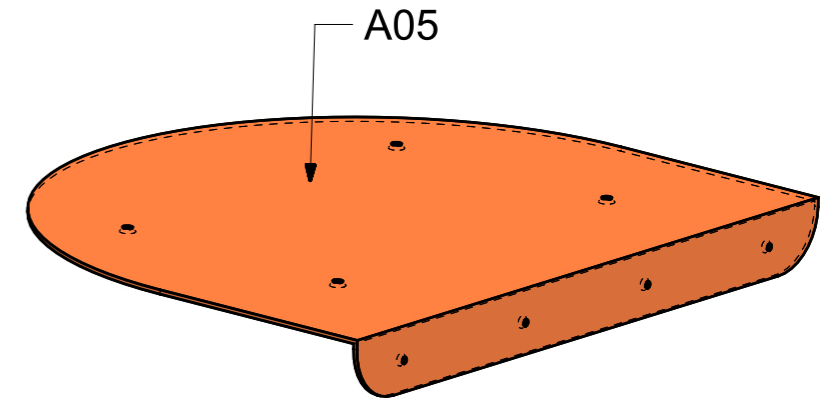
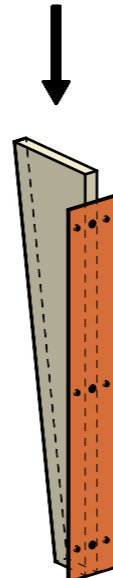

LOCALE	CODICE	DESCRIZIONE COMPONENTE	FINITURA	Q.TA
CABINA ARMATORE	MD299_A07A08_AO01	STRUTTURA TESTALETTO	ACCIAIO GREZZO	1

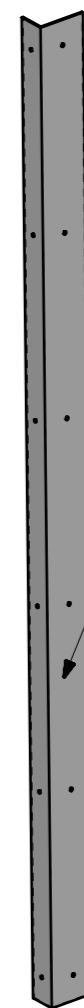
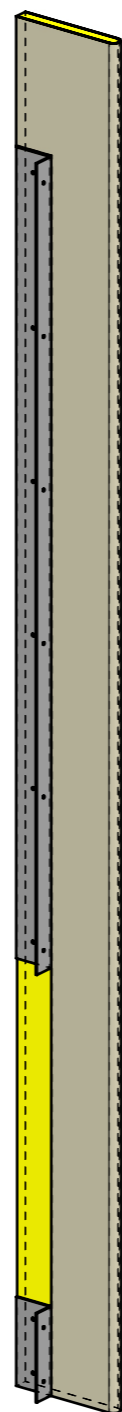
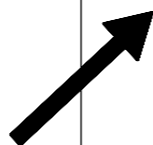
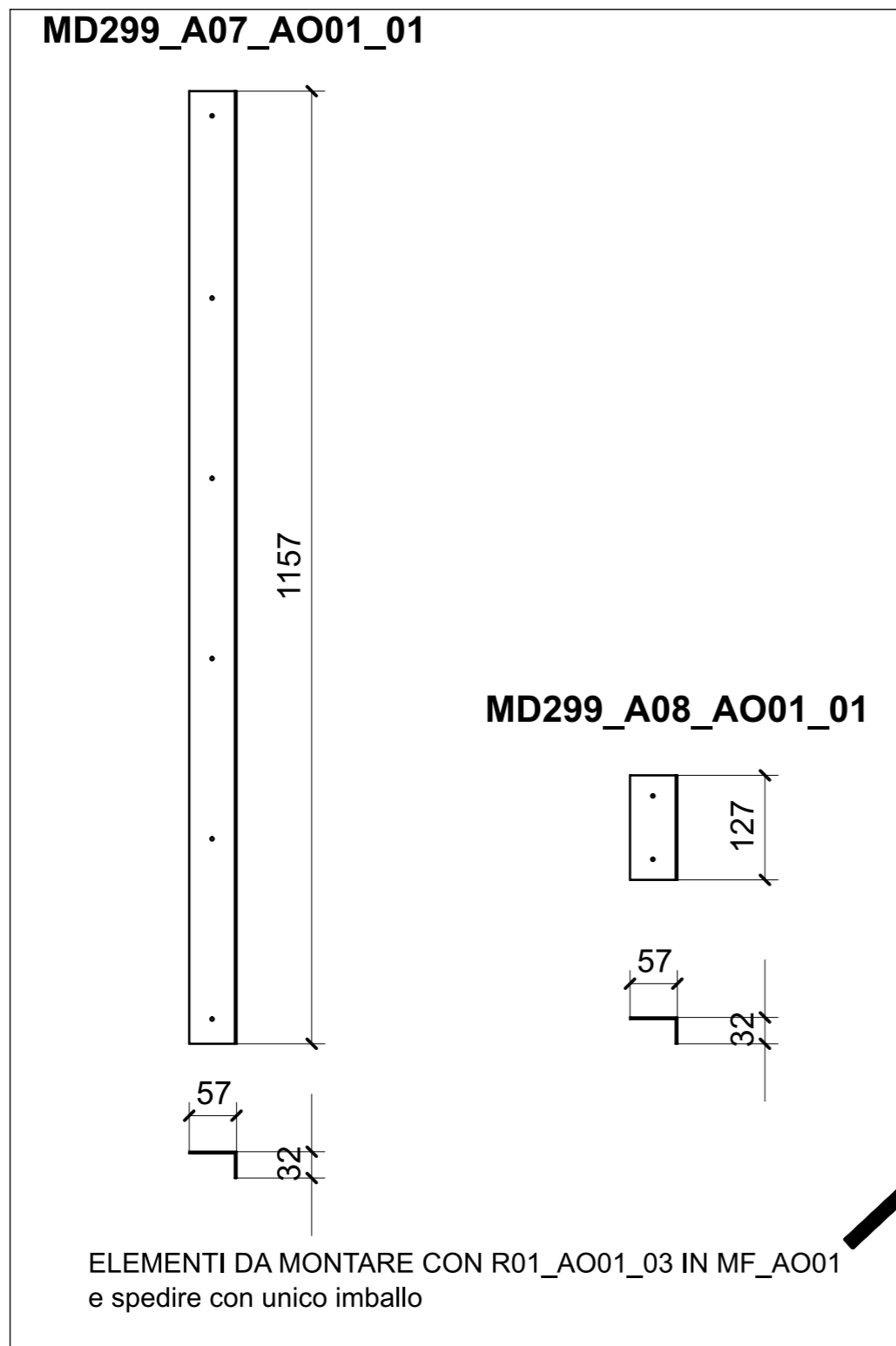

MD299_A07_AO01_01

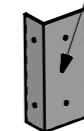

MD299_A08_AO01_01

LOCALE	CODICE	DESCRIZIONE COMPONENTE	FINITURA	Q.TA
CABINA ARMATORE	MD299_A01_AQ01	COMODINO SX_STD VAR 1	ACCIAIO SATINATO BRONZO AUDREY	1

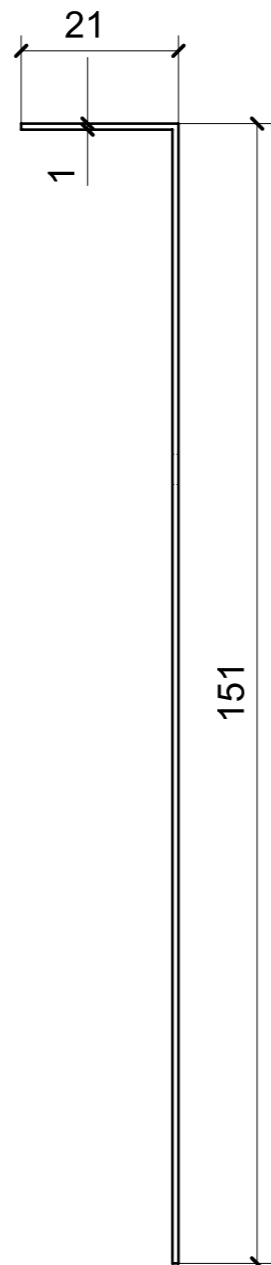
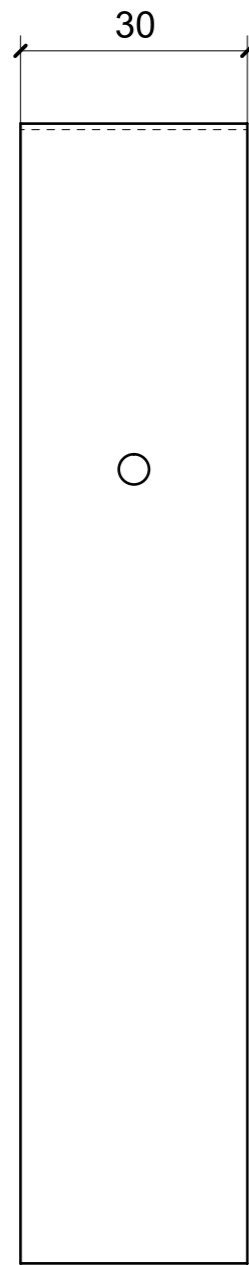

01

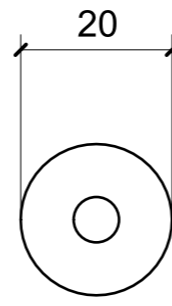
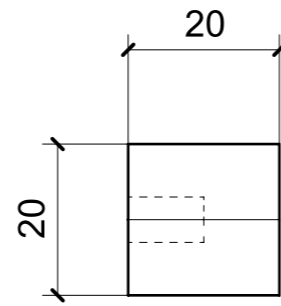

02

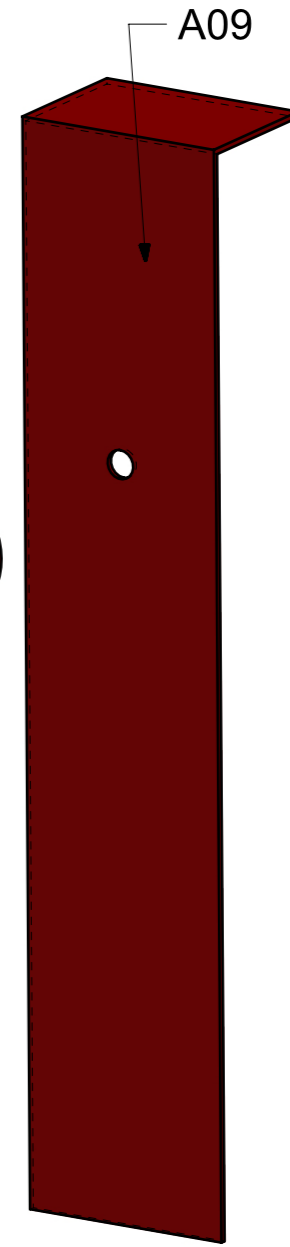
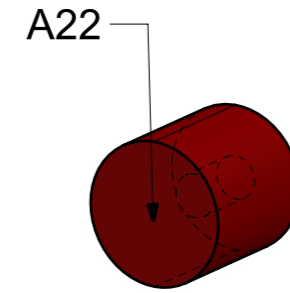

LOCALE	CODICE	DESCRIZIONE COMPONENTE	FINITURA	Q.TA
CABINA ARMATORE	MD299_A01_AR01	COMODINO DX_STD VAR 1	ACCIAIO SATINATO BRONZO AUDREY	1

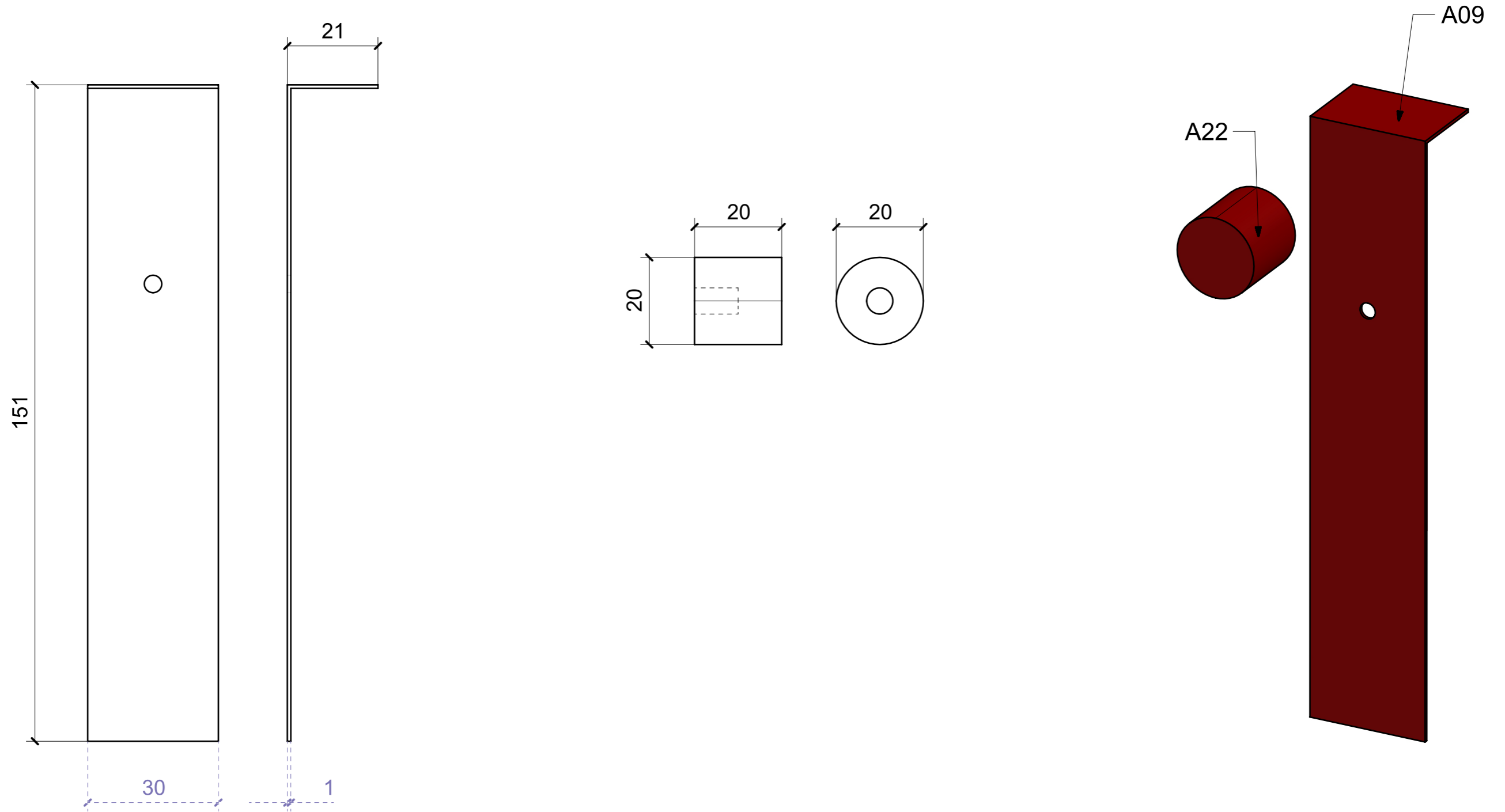

LOCALE	CODICE	DESCRIZIONE COMPONENTE	FINITURA	GR.
CABINA ARMATORE	MD299_A01_AU01	ANTE MOBILE MURATA_STD VAR 2 VERDE 100 GLOSS	ACCIAIO SATINATO BRONZO AUDREY	06

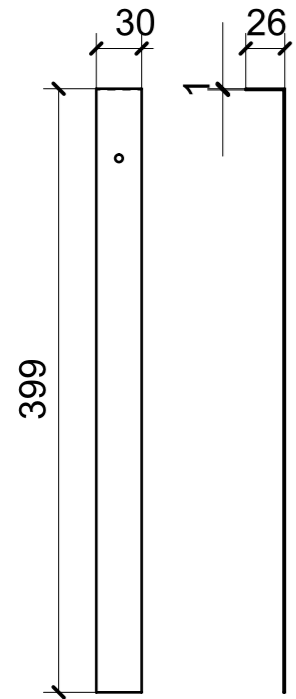

A10_01

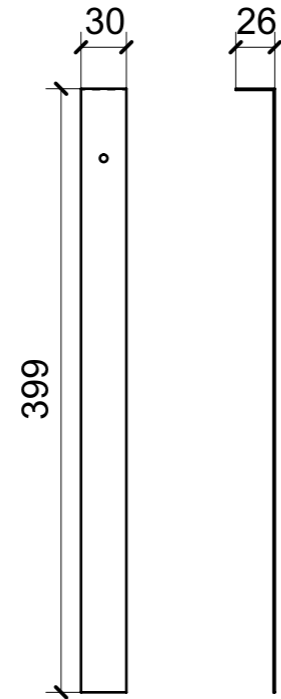

A10_02

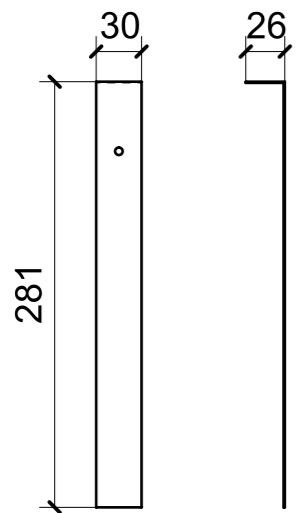

A11_01

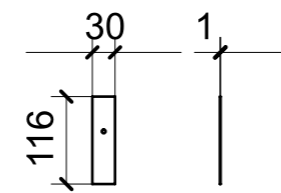

A12_01

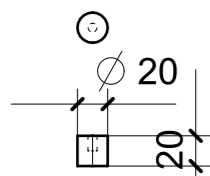

A22_01

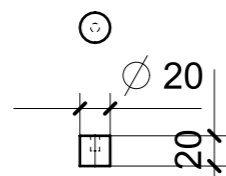

A22_02

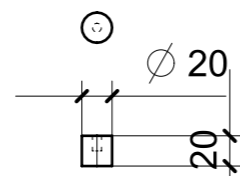

A22_03

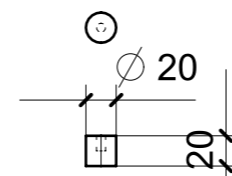

A22_04

ELEMENTI DA MONTARE CON L01_01/07 IN MF_AU01
e spedire con unico imballo

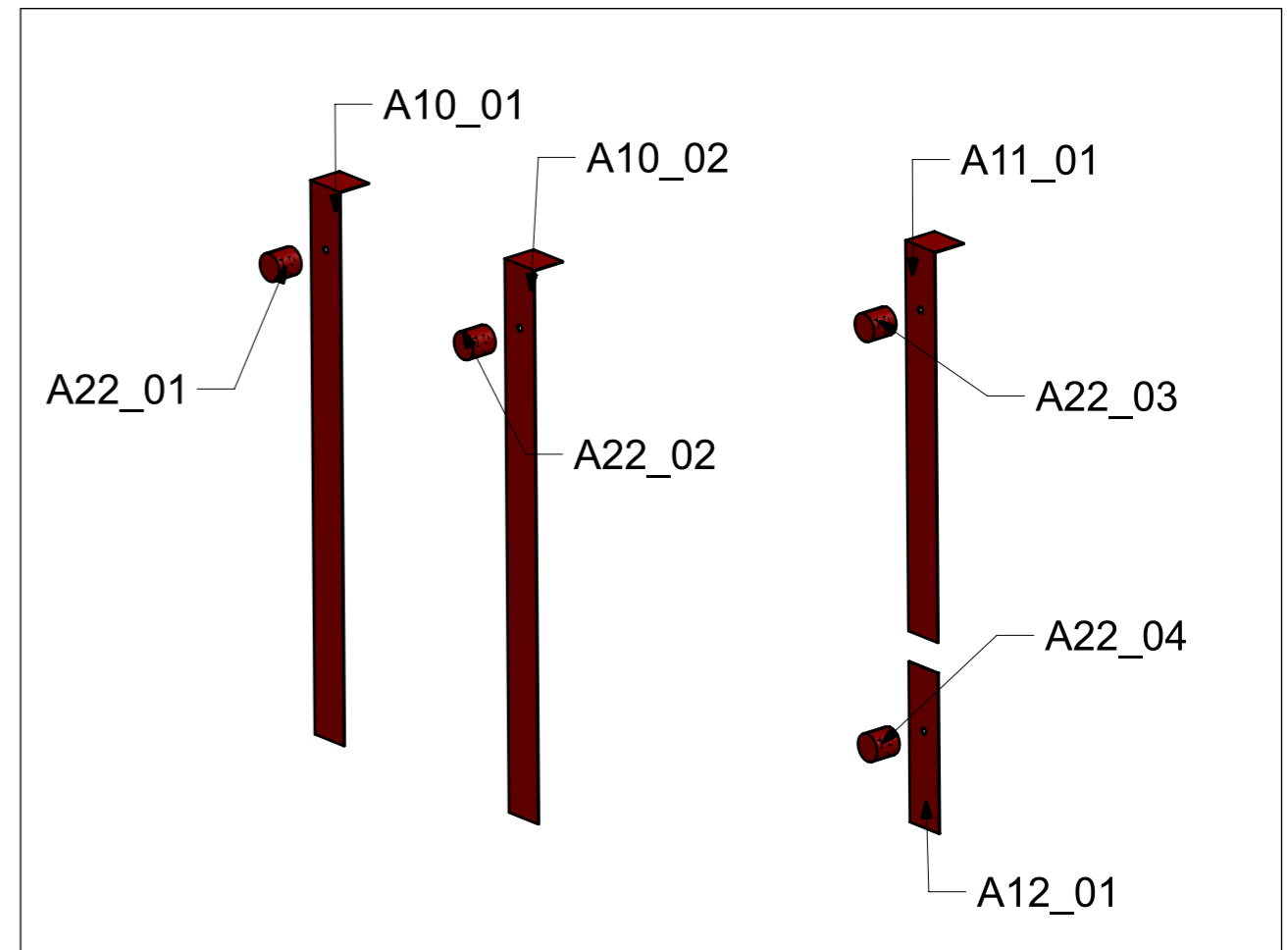
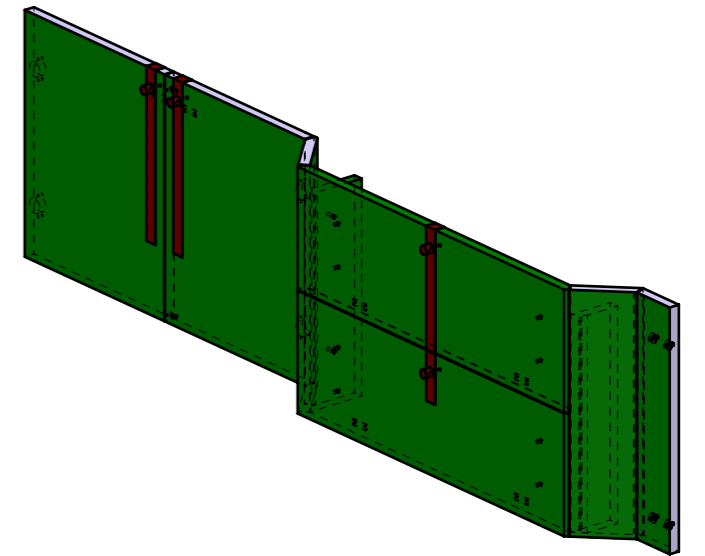

LOCALE	CODICE	DESCRIZIONE COMPONENTE	FINITURA	GR.
CABINA ARMATORE	MD299_A01_AV01	ANTE MOBILE MURATA_STD VAR 1 AZZURRO\GRIGIO 100 GLOSS	ACCIAIO SATINATO BRONZO AUDREY	06

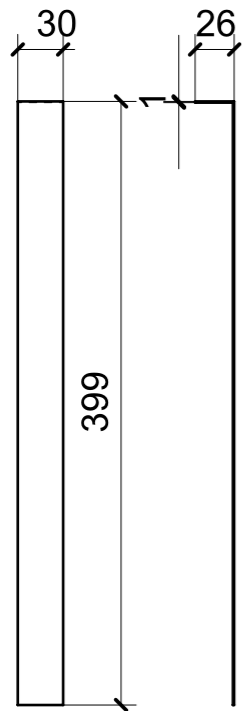

A10_01

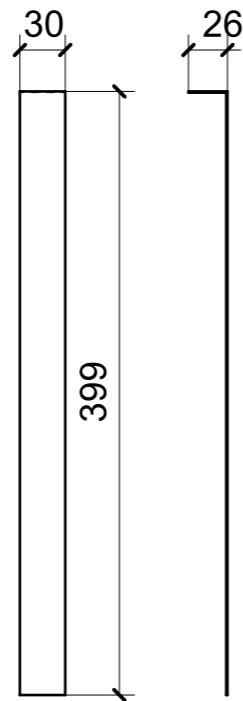

A10_02

ELEMENTI DA MONTARE CON L01_01/07 IN MF_AV01
e spedire con unico imballo

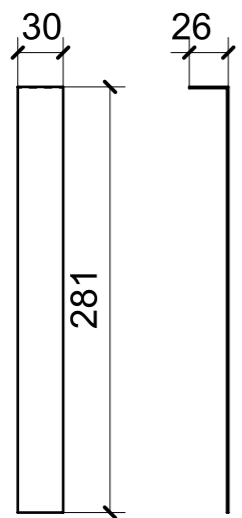
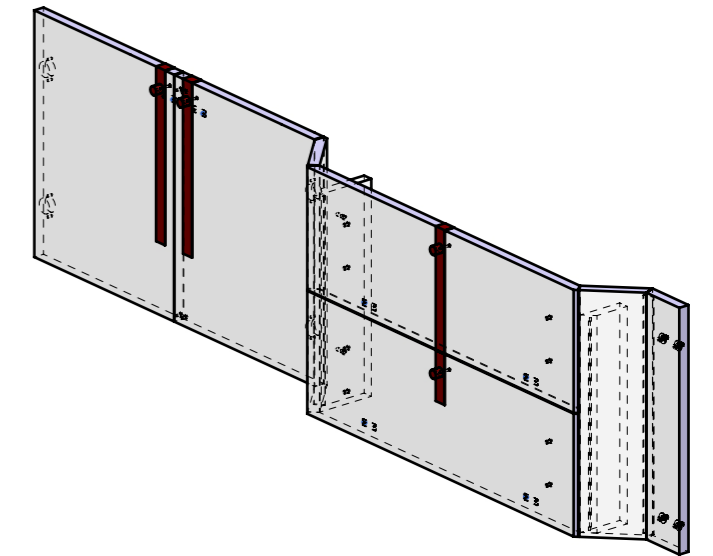

A11_01

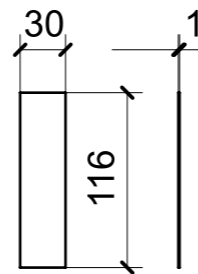

A12_01

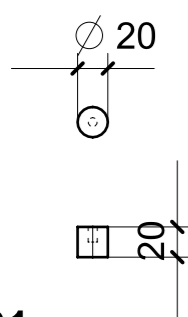
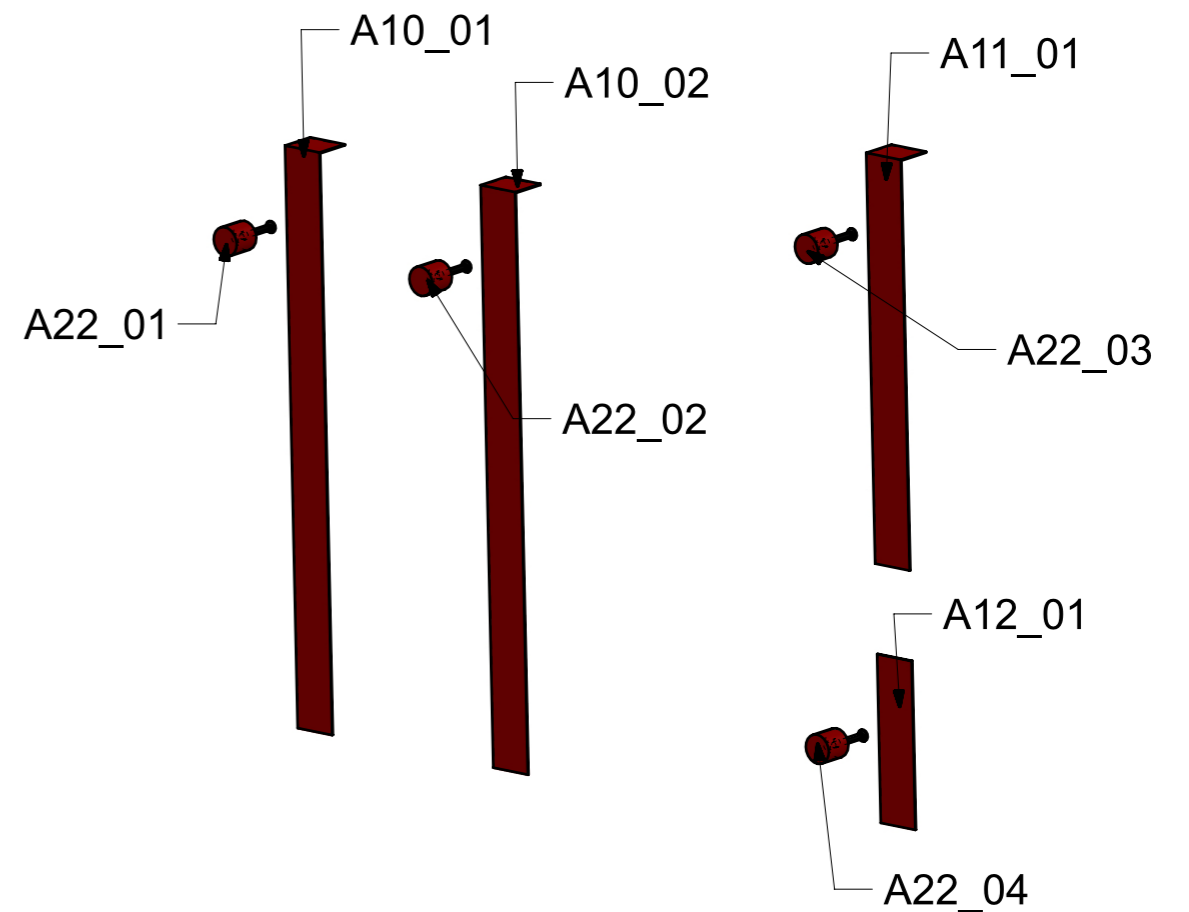

A22_01

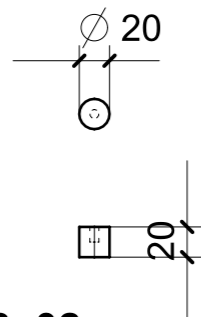

A22_02

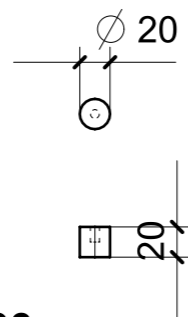

A22_03

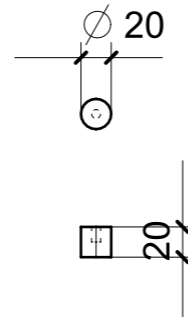

A22_04

LOCALE	CODICE	DESCRIZIONE COMPONENTE	FINITURA	Q.TA
CABINA ARMATORE	MD299_A01_AAQ01	COMODINO SX_STD VAR 2	ACCIAIO SATINATO BRONZO AUDREY	1

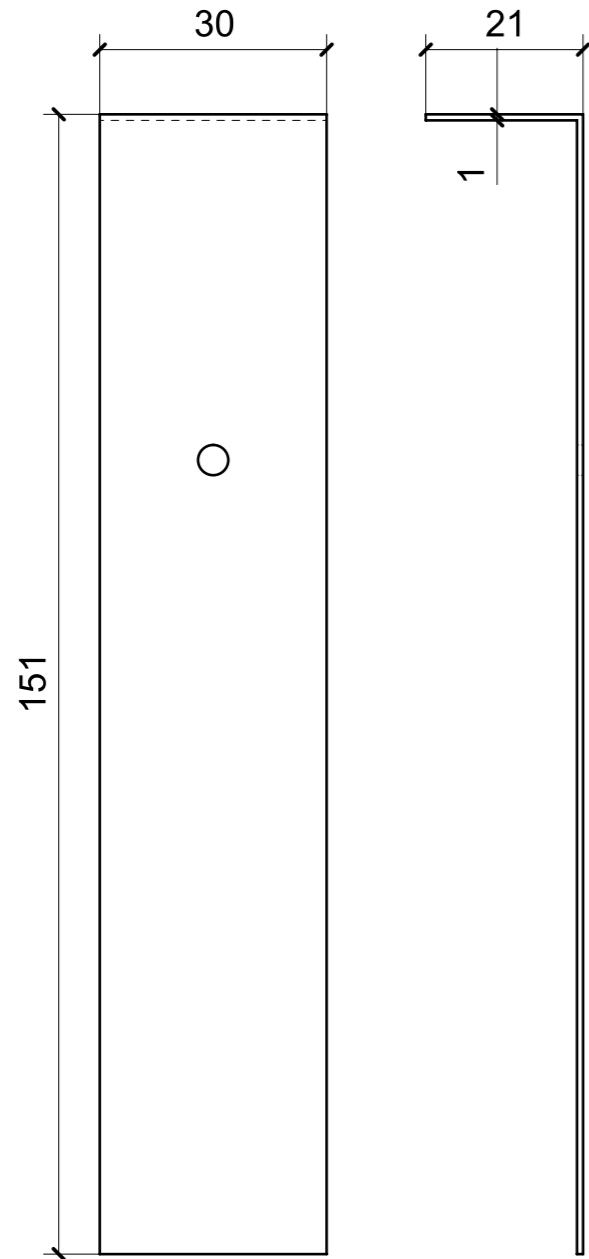

A09_AAQ01_01

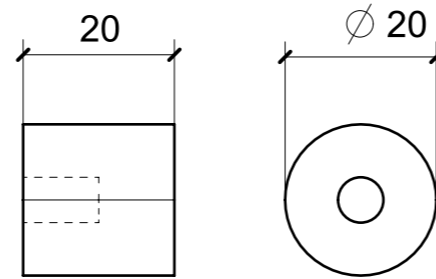

A22_AAQ01_01

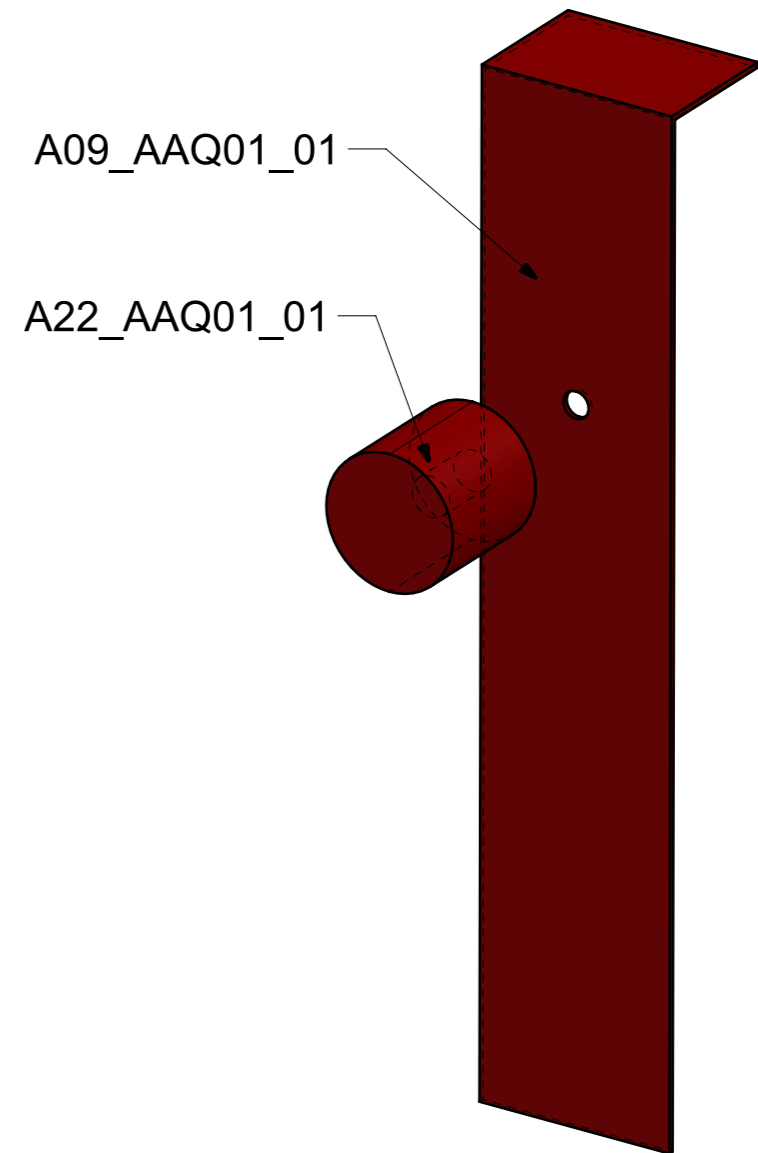

A09_AAQ01_01

A22_AAQ01_01

LOCALE	CODICE	DESCRIZIONE COMPONENTE	FINITURA	Q.TA
CABINA ARMATORE	MD299_A01_AAR01	COMODINO DX_STD VAR 2	ACCIAIO SATINATO BRONZO AUDREY	1

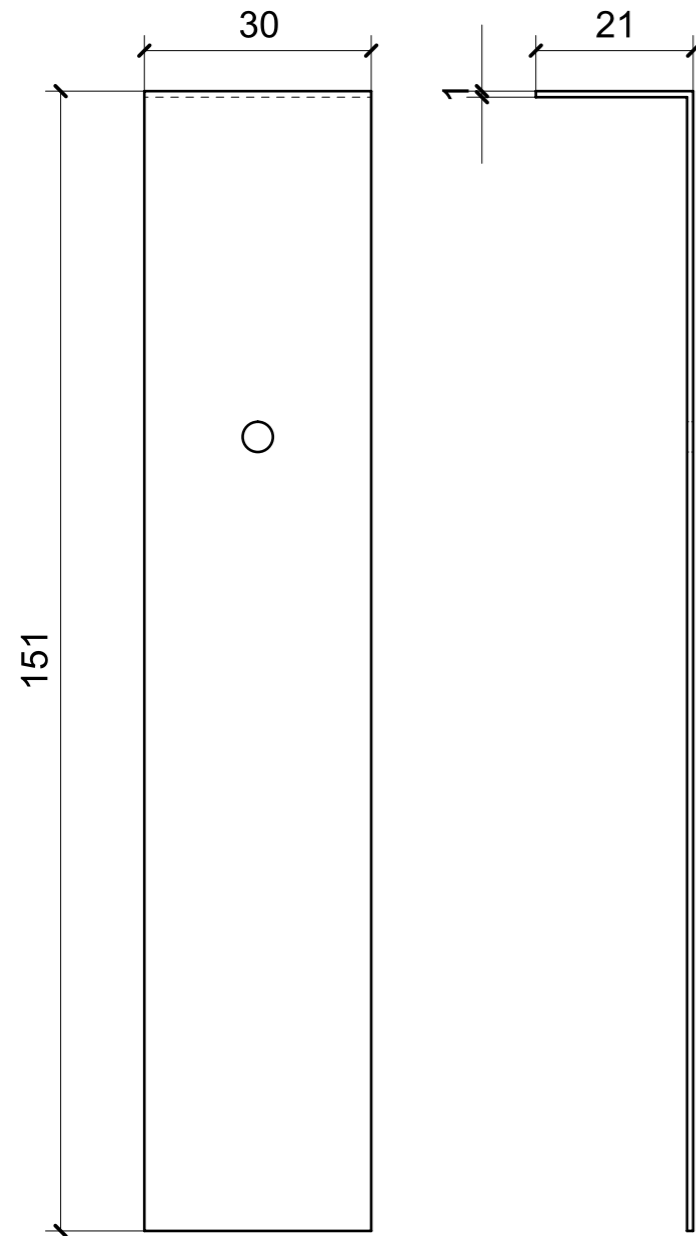

A09_AAR01_01

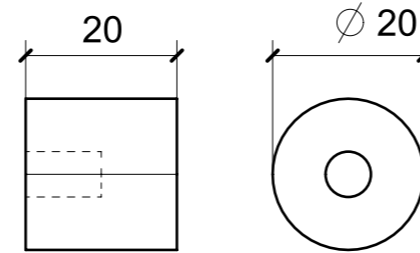

A22_AAR01_01

