

LOCALE	CODICE	DESCRIZIONE COMPONENTE	FINITURA	Q.TA
SALONE	MD299_I01_SA01	COLONNA SX POPPA	OKUME' GREZZO	1

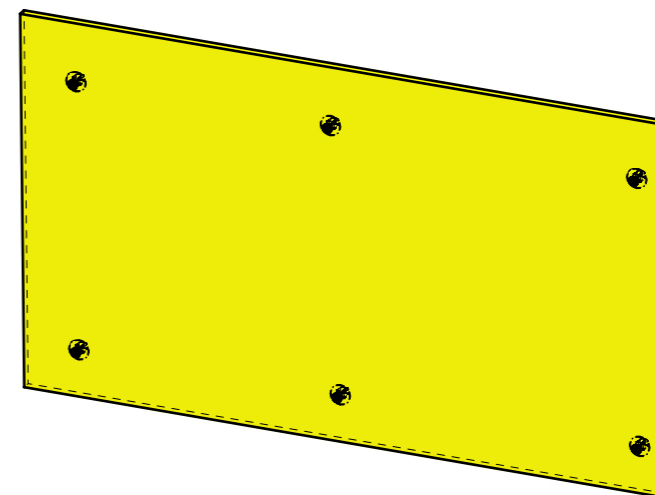

FERRAMENTA	QTY
MS INCASSO_ITALVIPLA_972_FMPC_M1B	6

LOCALE	CODICE	DESCRIZIONE COMPONENTE	FINITURA	Q.TA
SALONE	MD299_I01_SB01	COLLEGAMENTO BASSO SX	OKUME' GREZZO	1

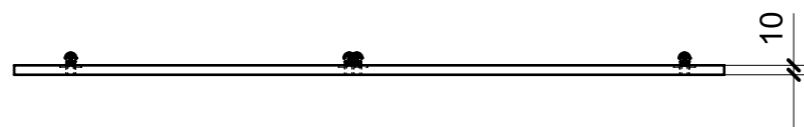
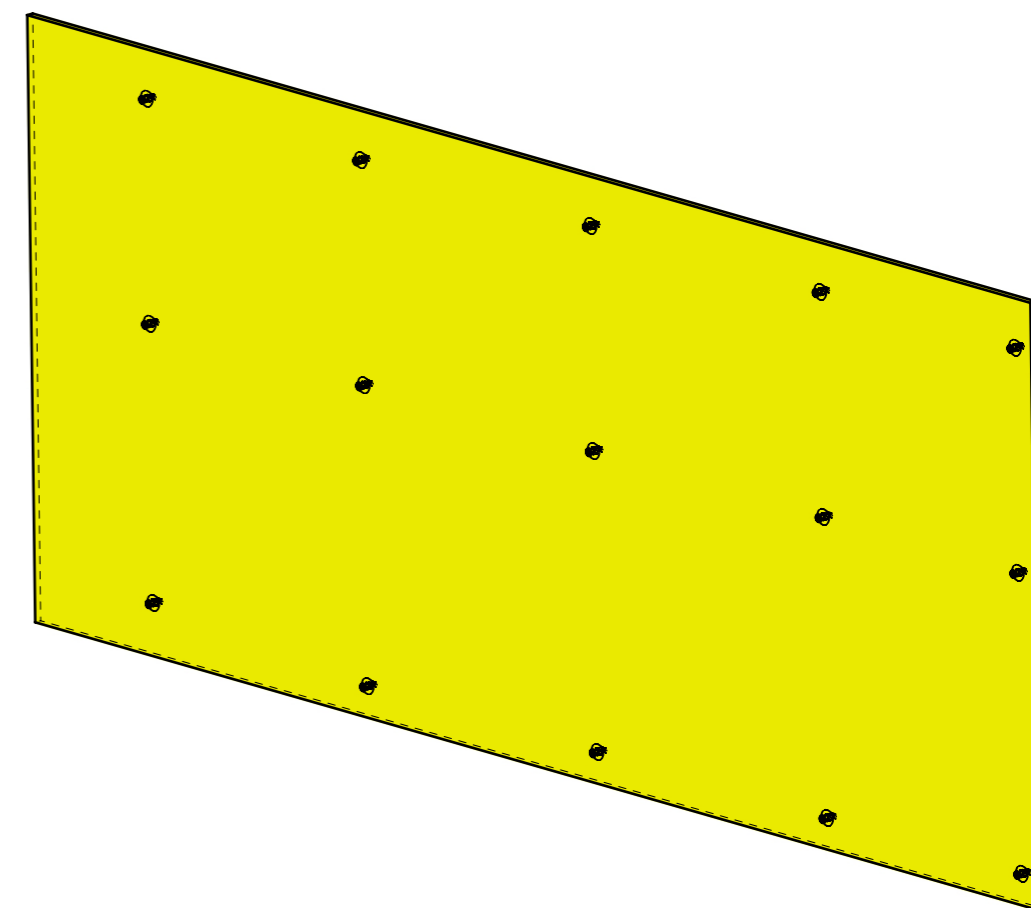
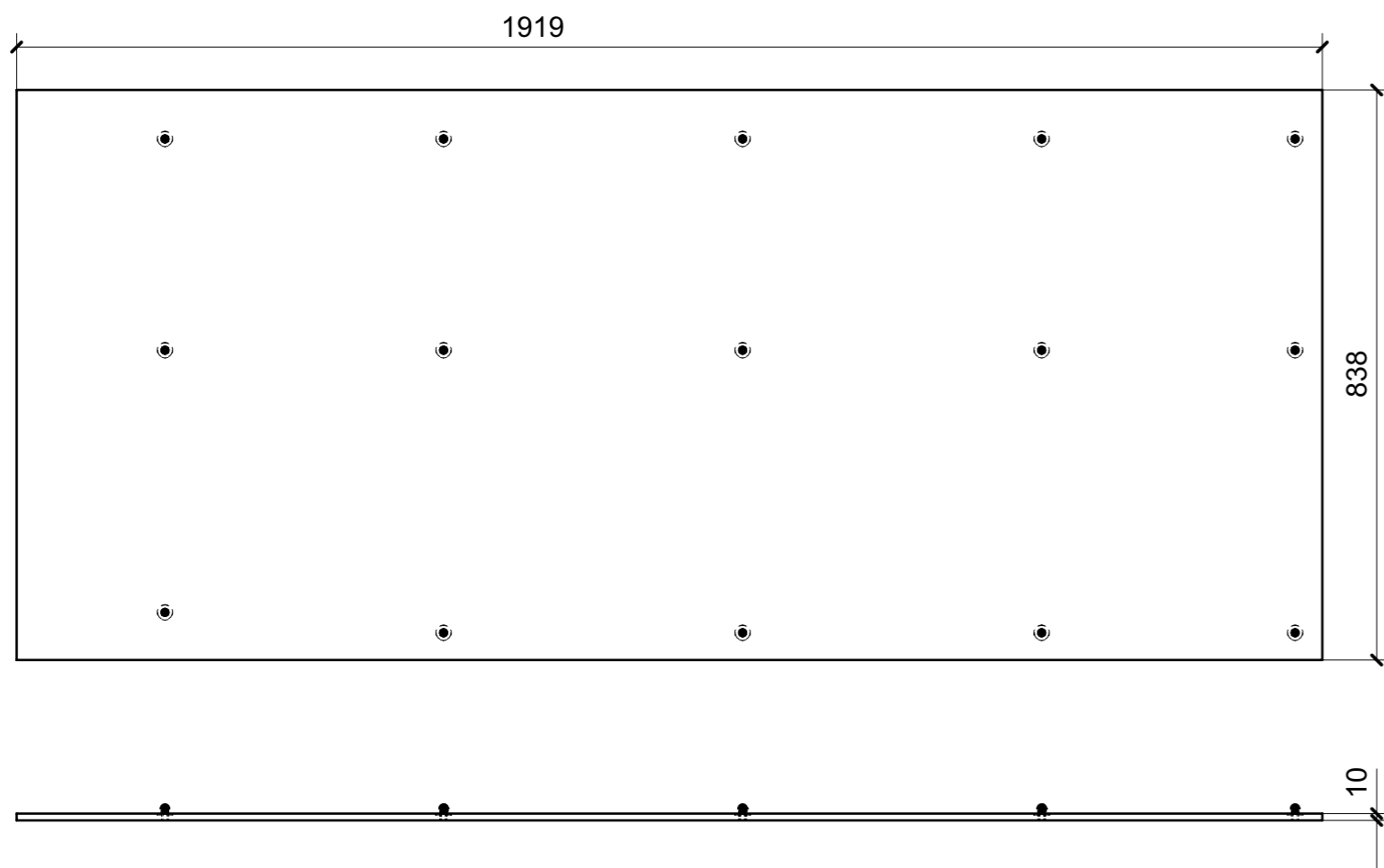

FERRAMENTA	QTY
MS INCASSO_ITALVIPLA_972_FMPC_M1B	15

LOCALE	CODICE	DESCRIZIONE COMPONENTE	FINITURA	Q.TA
SALONE	MD299_I01_SC01	STRUTTURA SX PRUA	OKUME' GREZZO	1

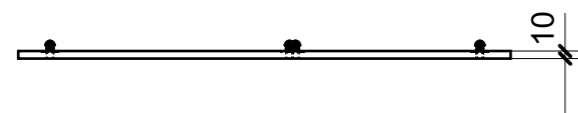
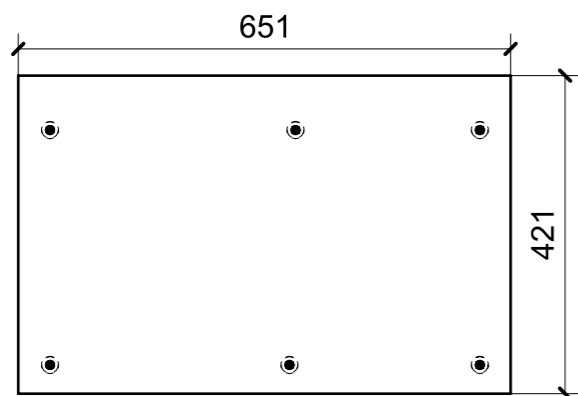

01

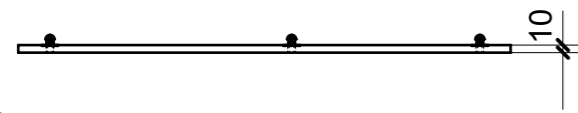
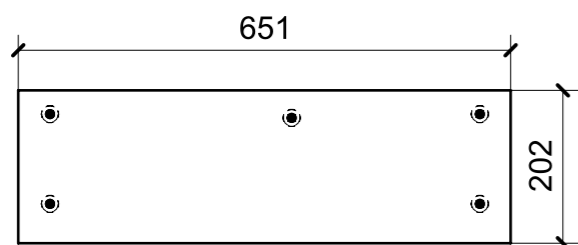

02

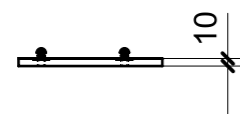
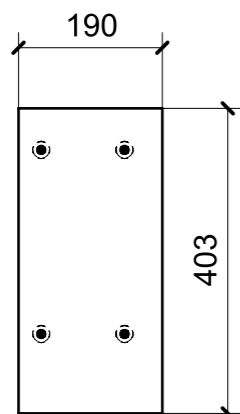

05

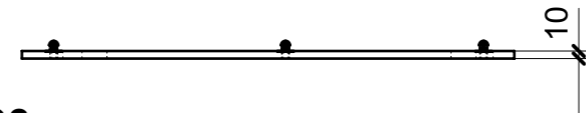
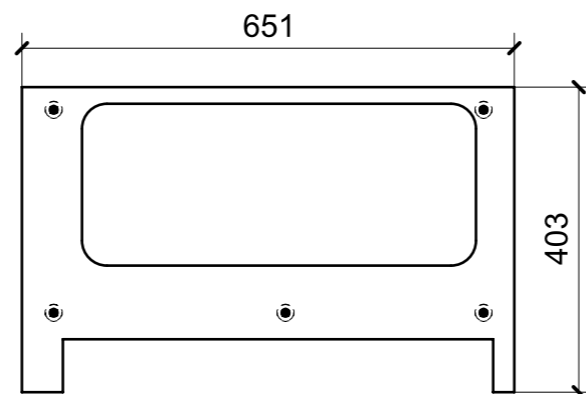

03

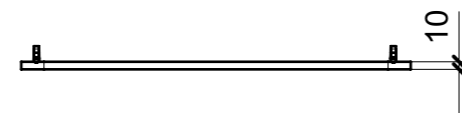
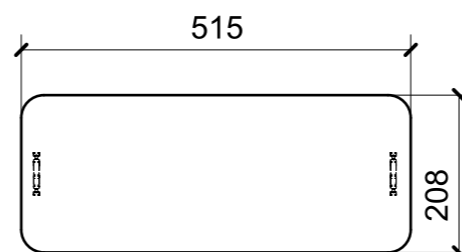

04

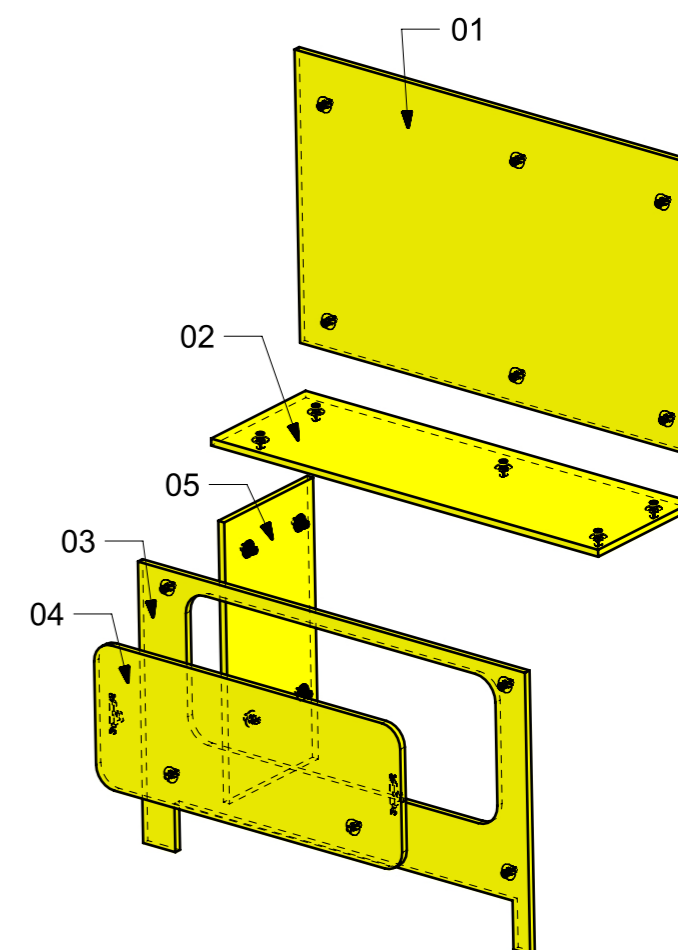

FERRAMENTA	QTY
MS INCASSO_ITALVIPLA_972_FMPC_M1B	20

LOCALE	CODICE	DESCRIZIONE COMPONENTE	FINITURA	Q.TA
SALONE	MD299_I01_SG01	COLLEGAMENTO BASSO DX PRUA	OKUME' GREZZO	1

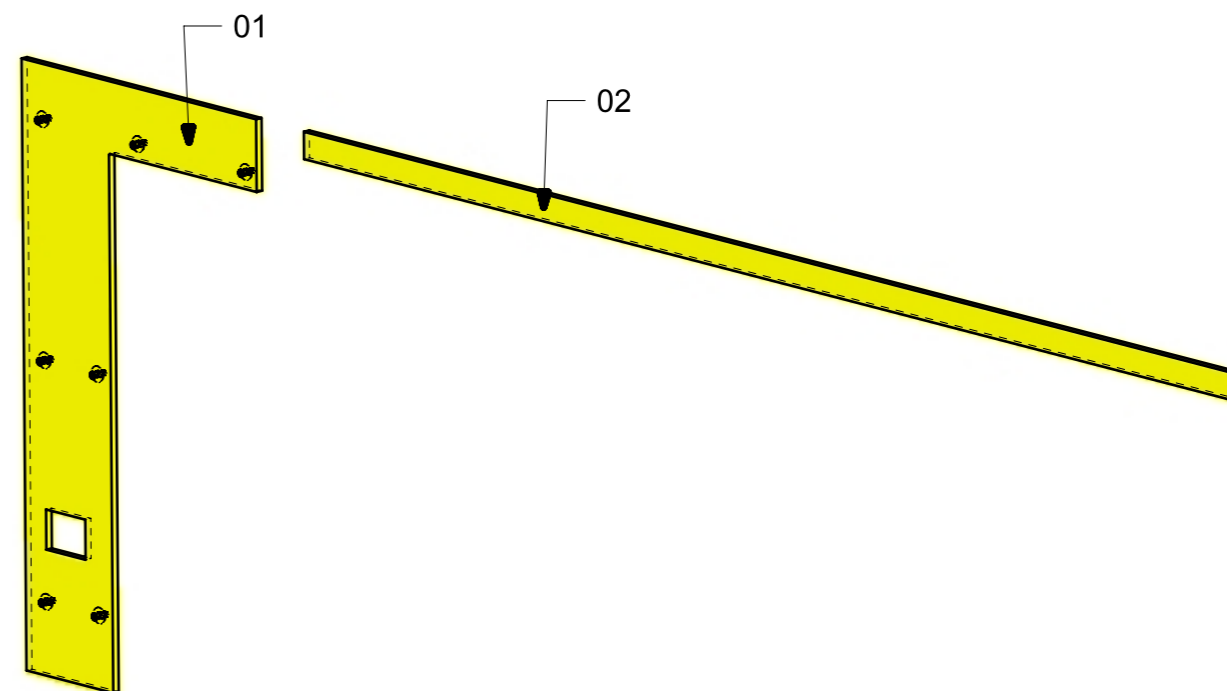
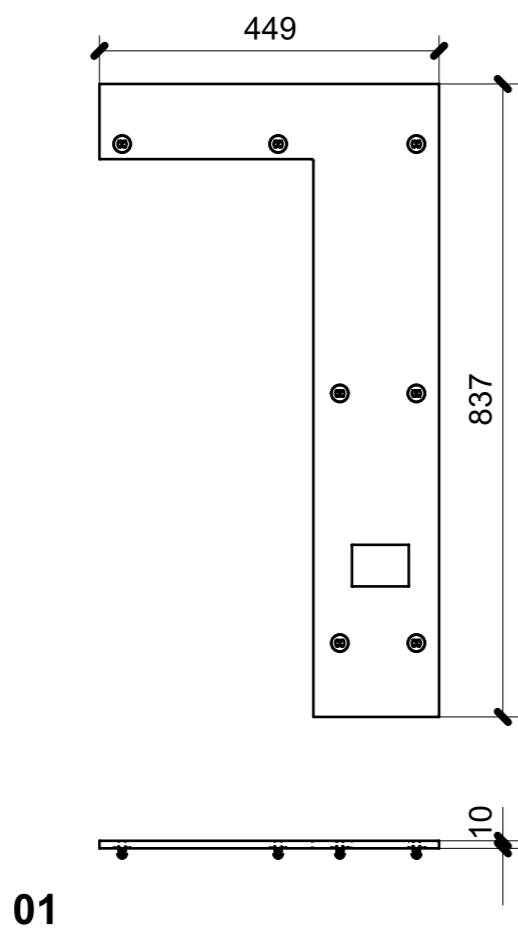

FERRAMENTA	QTY
MS INCASSO_ITALVIPLA_972_FMPC_M1B	7

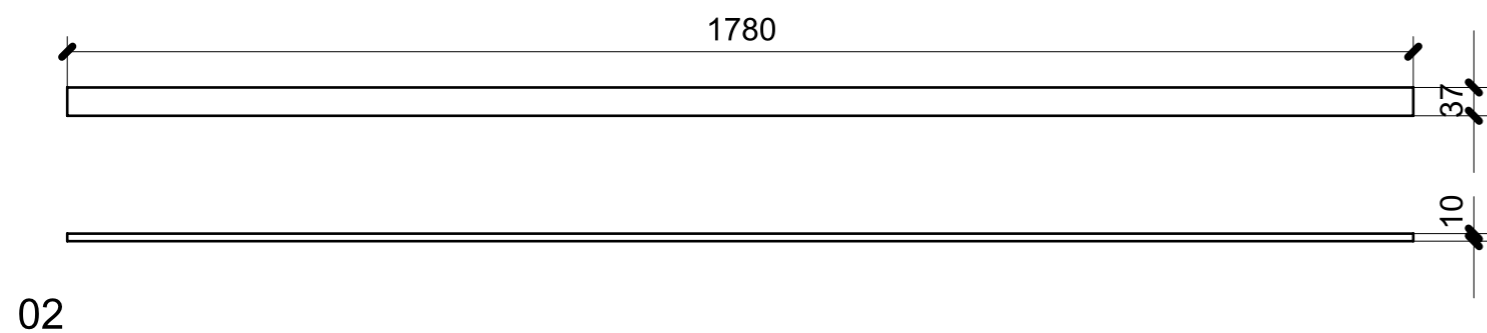

LOCALE	CODICE	DESCRIZIONE COMPONENTE	FINITURA	Q.TA
SALONE	MD299_I01_SI01	COLONNA DX CENTRO	OKUME' GREZZO	1

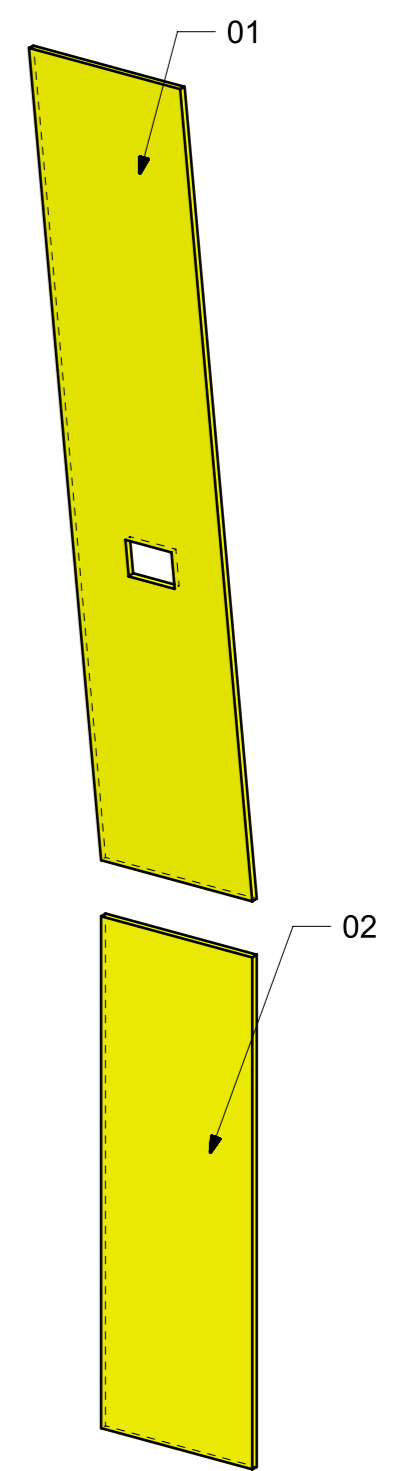
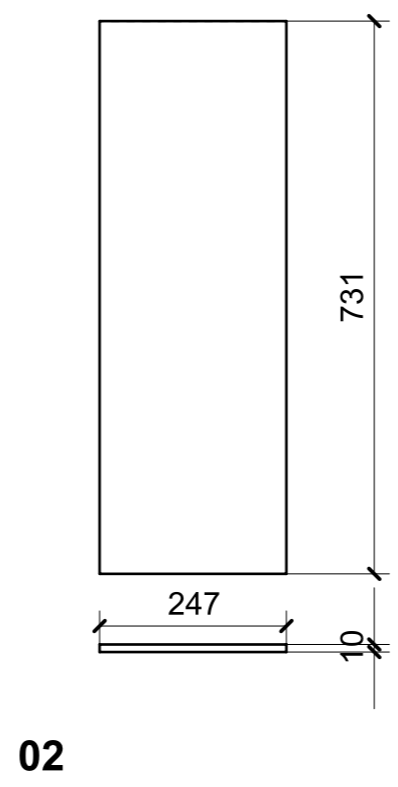
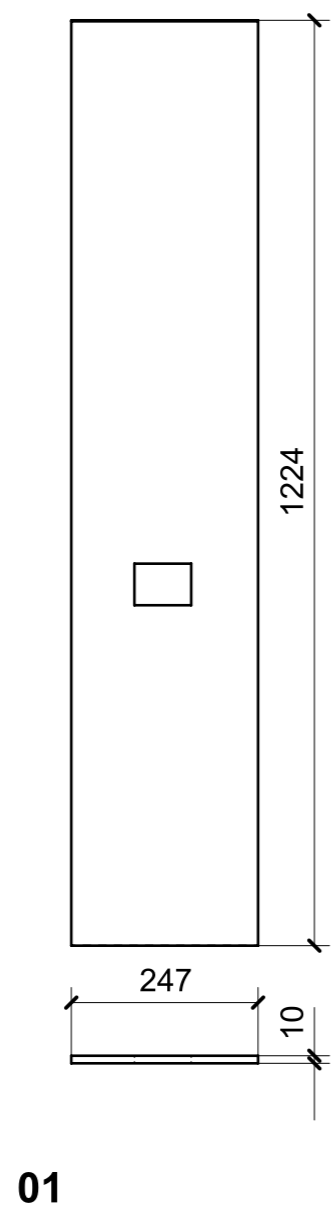

LOCALE	CODICE	DESCRIZIONE COMPONENTE	FINITURA	Q.TA
SALONE	MD299_I01_SJ01	COLONNA DX PRUA	OKUME' GREZZO	1

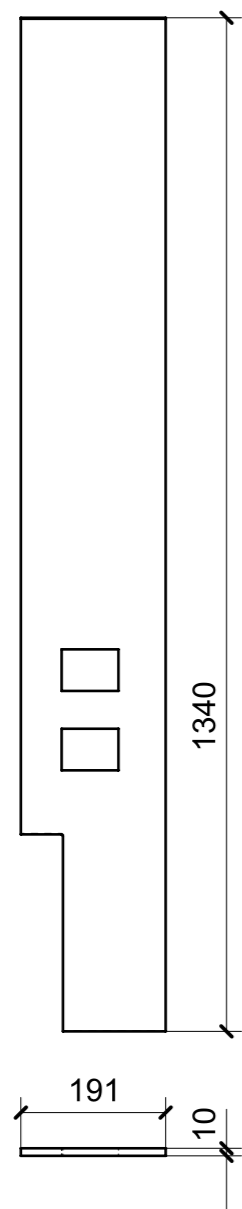

01

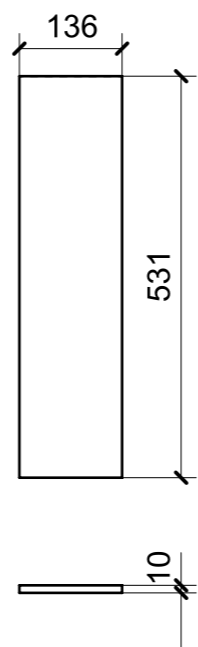

02

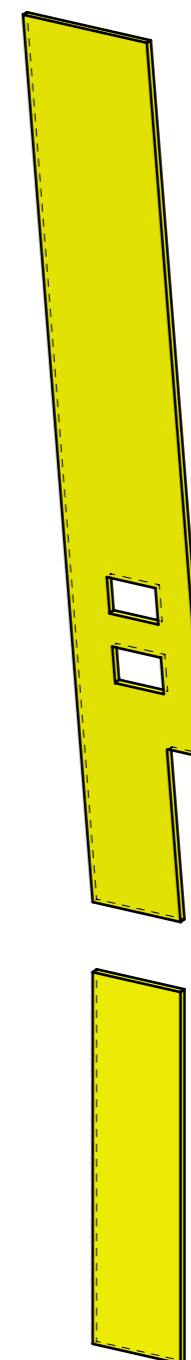

LOCALE	CODICE	DESCRIZIONE COMPONENTE	FINITURA	Q.TA
SALONE	MD299_I01_SL01	COLLEGAMENTO SCHIENALE DINETTE	OKUME' GREZZO	1

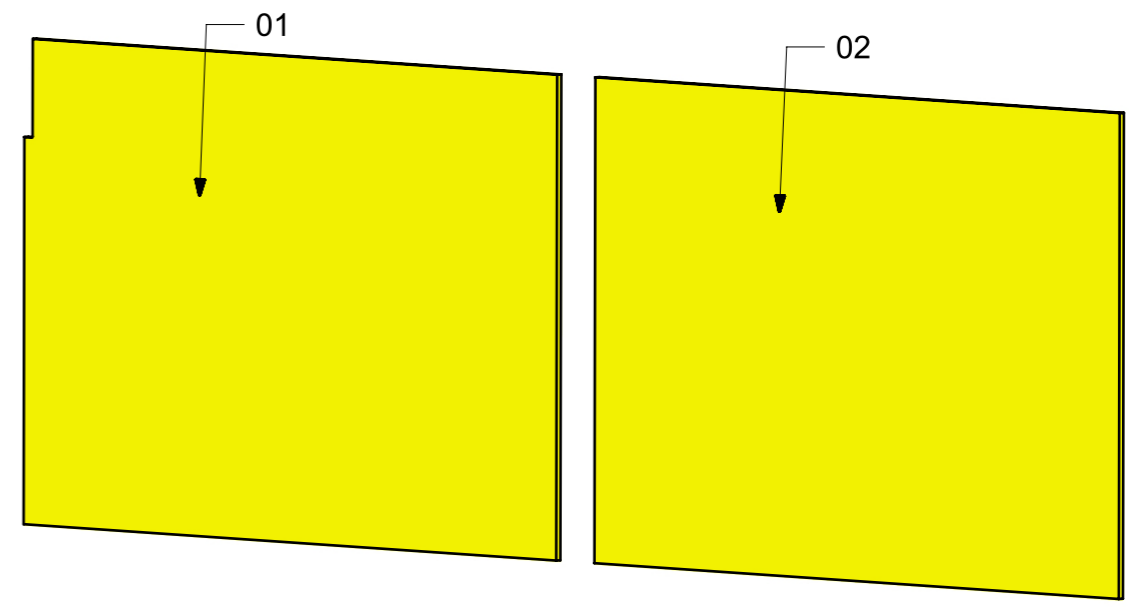
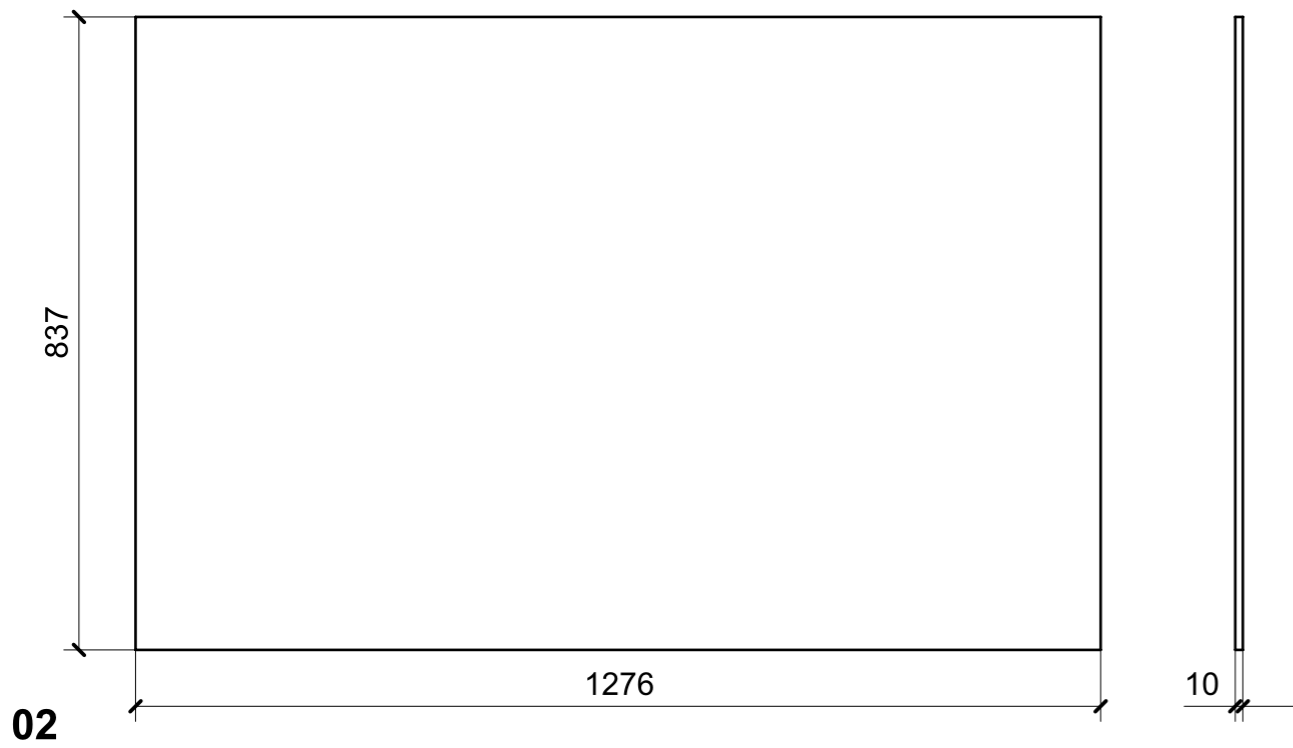
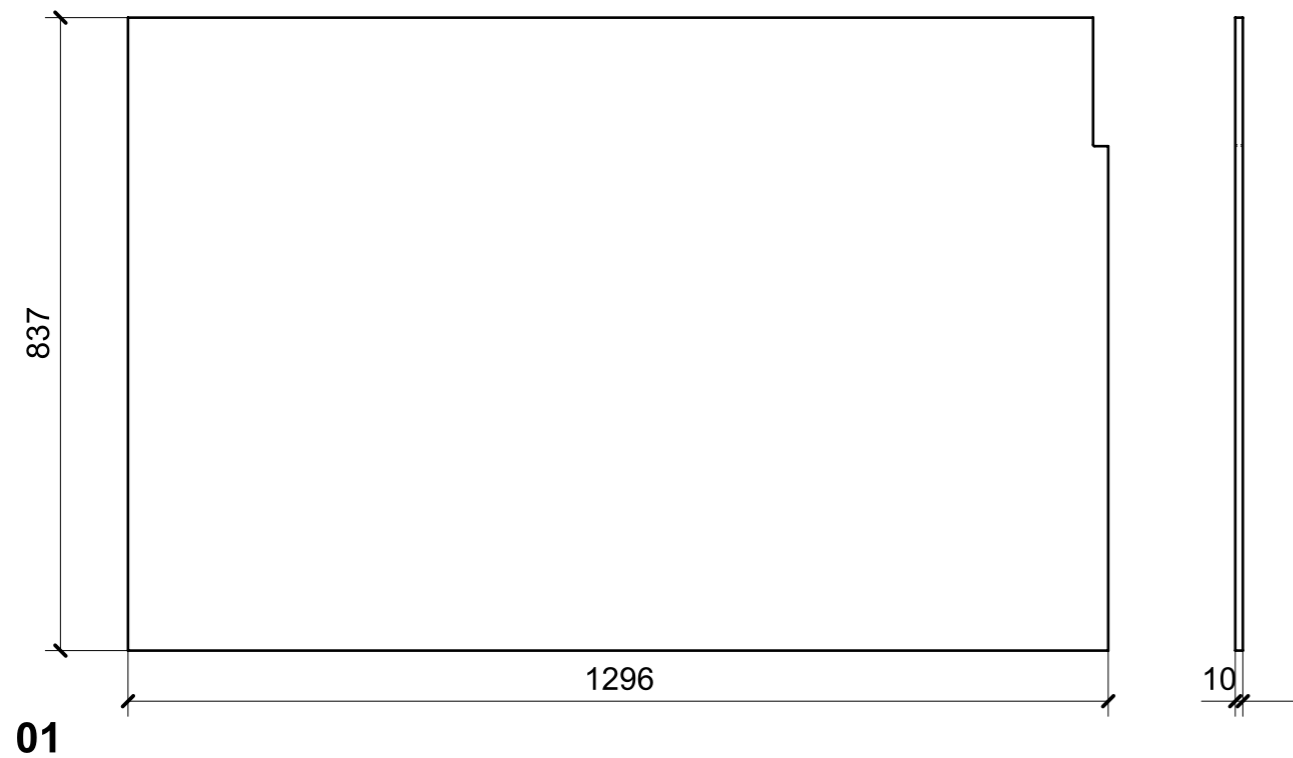

LOCALE	CODICE	DESCRIZIONE COMPONENTE	FINITURA	Q.TA
SALONE	MD299_I01_SM01	COLONNA DX PRUA GUIDA	OKUME' GREZZO	1

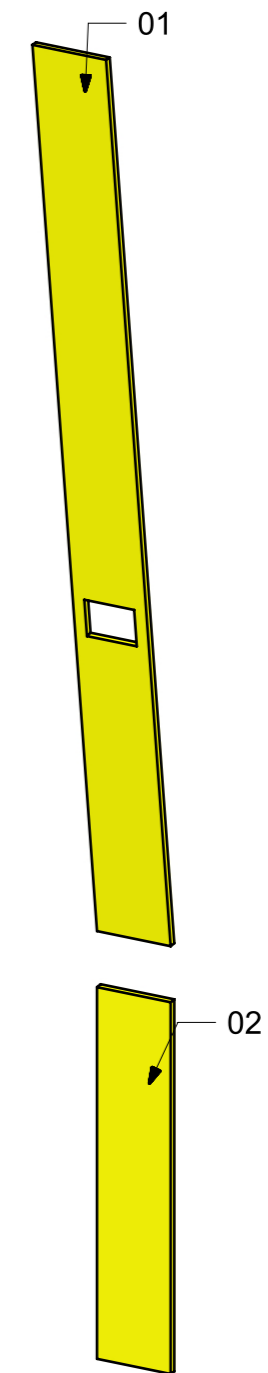
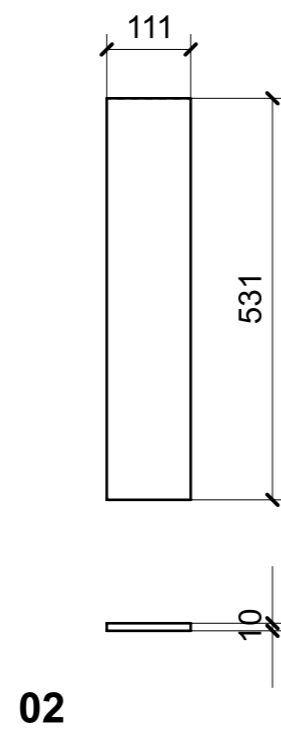
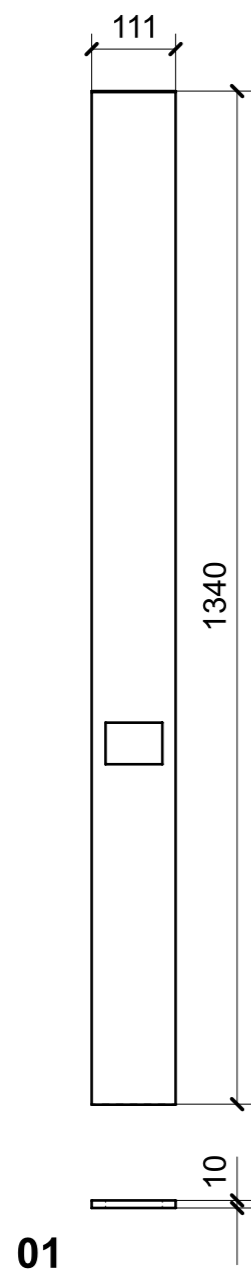

LOCALE	CODICE	DESCRIZIONE COMPONENTE	FINITURA	Q.TA
SALONE	MD299_I01_SP01	CIELINO PLENUM SX CENTRO MURATA	OKUME' GREZZO	1

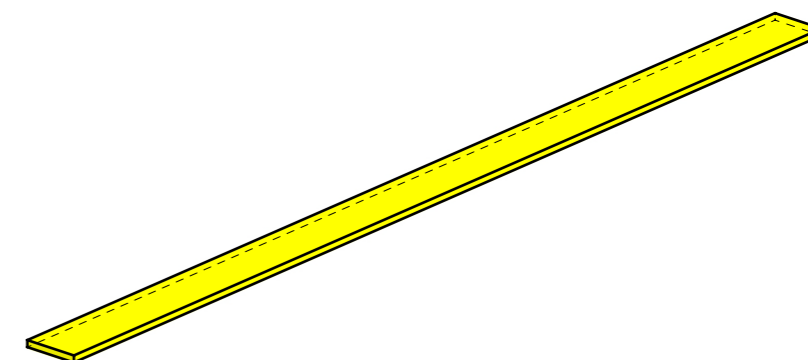
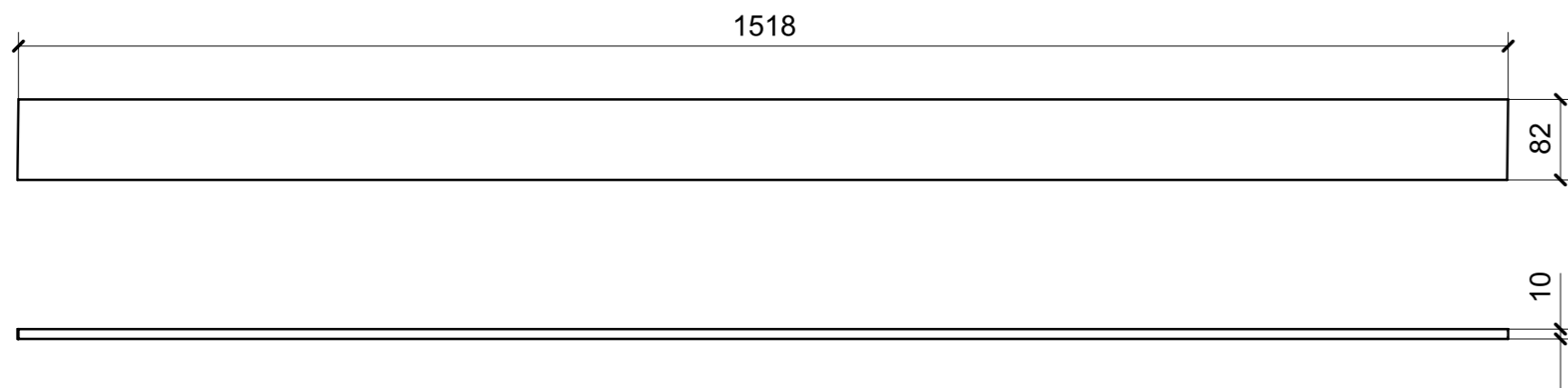

LOCALE	CODICE	DESCRIZIONE COMPONENTE	FINITURA	Q.TA
SALONE	MD299_I01_SQ01	CIELINO PLENUM SX POPPA	OKUME' GREZZO	1

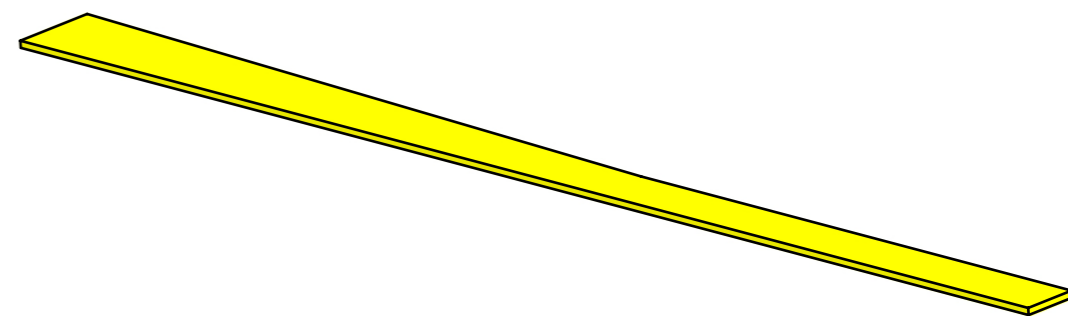
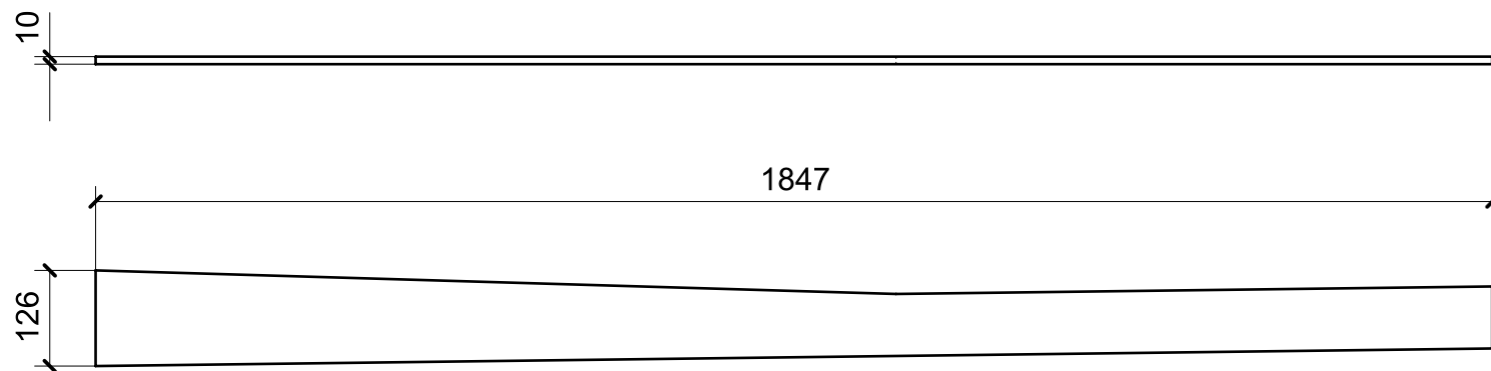

LOCALE	CODICE	DESCRIZIONE COMPONENTE	FINITURA	Q.TA
SALONE	MD299_I01_SR01	TRAVERSA INGRESSO SOFFITTO	OKUME' GREZZO	1

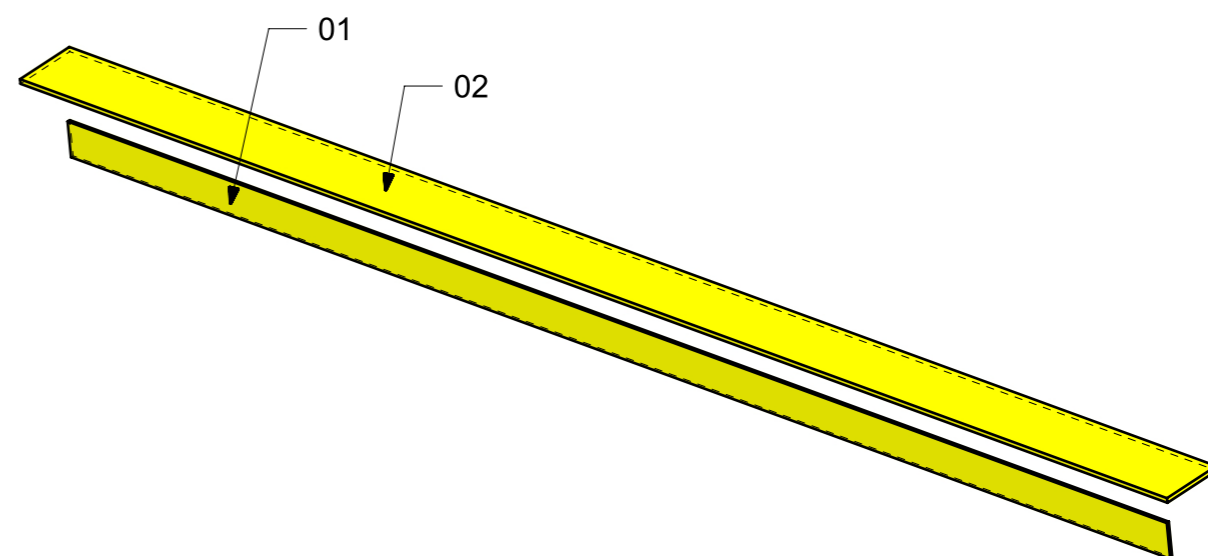
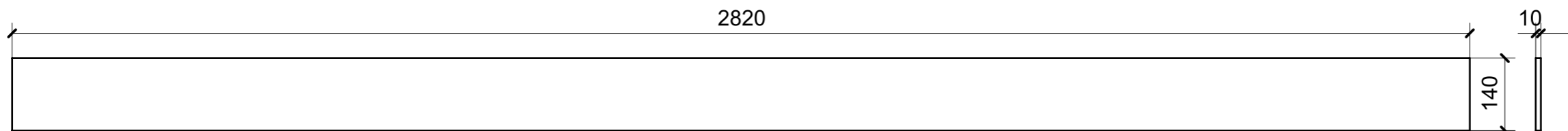
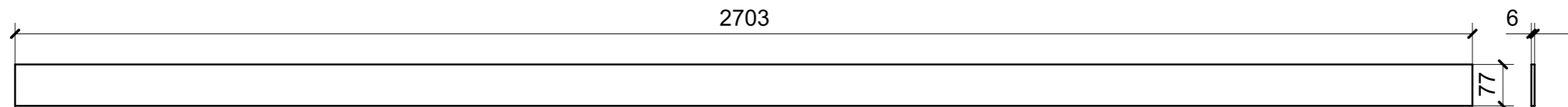

LOCALE	CODICE	DESCRIZIONE COMPONENTE	FINITURA	Q.TA
SALONE	MD299_I01_SS01	CIELINO PLENUM DX POPPA	OKUME' GREZZO	1

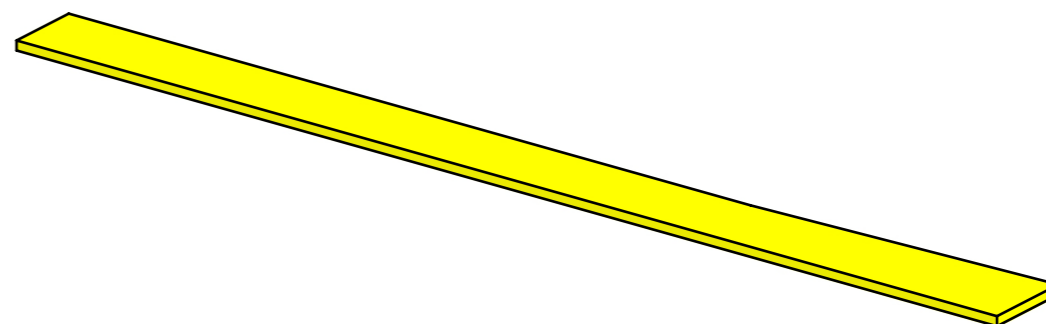
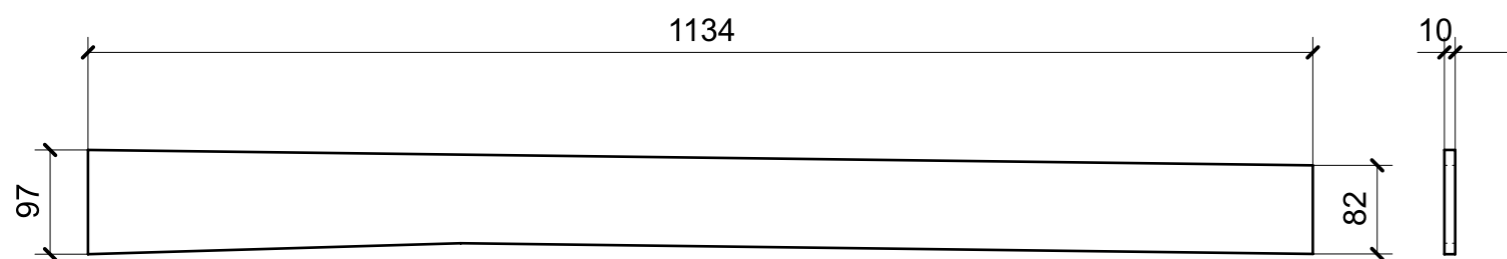

LOCALE	CODICE	DESCRIZIONE COMPONENTE	FINITURA	Q.TA
SALONE	MD299_I01_ST01	CIELINO PLENUM DX CENTRO MURATA	OKUME' GREZZO	1

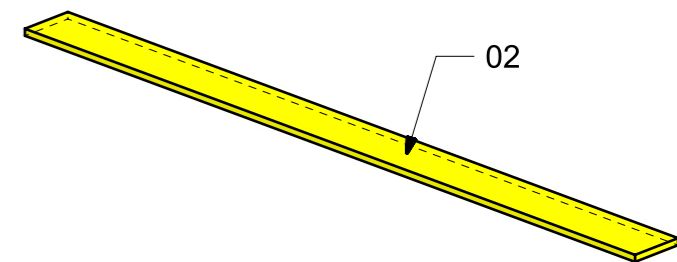
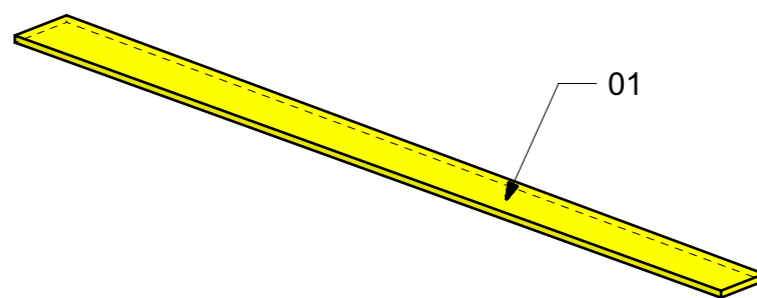
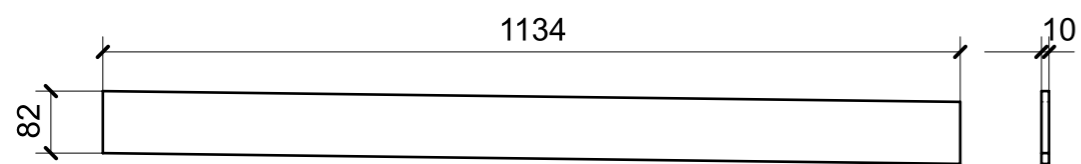
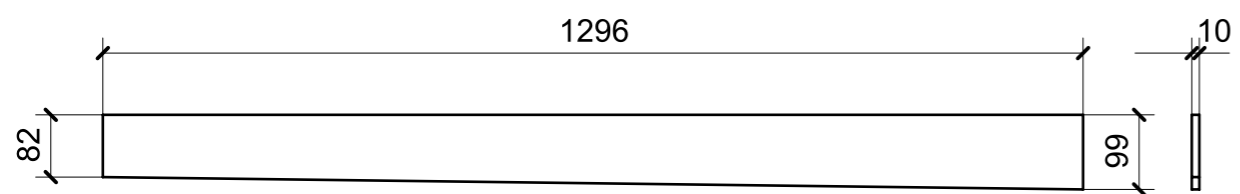

LOCALE	CODICE	DESCRIZIONE COMPONENTE	FINITURA	Q.TA
SALONE	MD299_I01_SW01	CIELINO PLENUM DX PRUA	OKUME' GREZZO	1

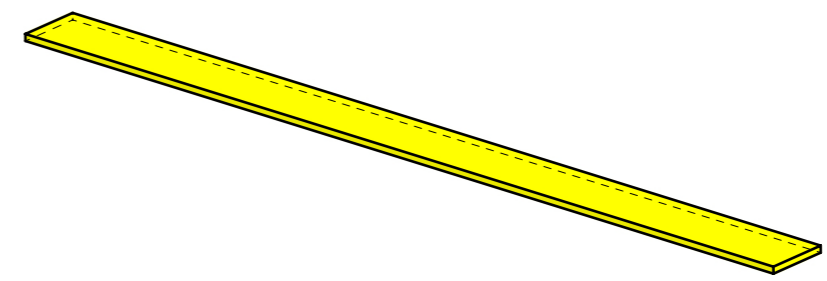
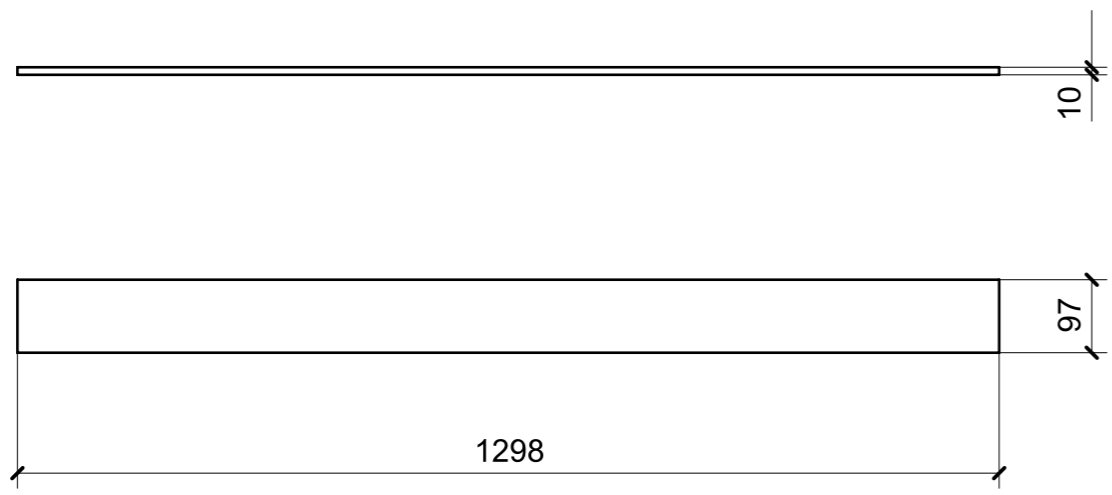

LOCALE	CODICE	DESCRIZIONE COMPONENTE	FINITURA	Q.TA
SALONE	MD299_I01_SX01	CIELINO PLENUM SX PRUA	OKUME' GREZZO	1

